

IDA ANNOTATION – 13 DECEMBER 2000

SINGTEL RESPONSE – 11 JANUARY 2001

SCHEDULE 1

PHYSICAL AND VIRTUAL INTERCONNECTION

SCHEDULE 1
PHYSICAL AND VIRTUAL INTERCONNECTION

CONTENTS

- SCHEDULE 1A - PHYSICAL AND VIRTUAL INTERCONNECTION FOR FBOs**
 - 1A ANNEXES**
- SCHEDULE 1B - VIRTUAL INTERCONNECTION FOR SBOs**
 - 1B ANNEXES**

SCHEDULE 1

PHYSICAL AND VIRTUAL INTERCONNECTION

SCHEDULE 1- MODIFICATION REQUIRED

As noted in Schedule A Paragraph 1, SingTel must modify the proposed RIO to provide that, where appropriate, both Licensees will have mutual rights and obligations. In implementing this modification, SingTel should bear in mind that the Requesting Licensee will not only be purchasing IRS from SingTel, but will also be providing origination, transit and termination services to SingTel.

SingTel comments: Noted.

1. GENERAL

- 1.1 This Schedule details the establishment of Interconnection between SingTel's Network and the Requesting Licensee's Network and describes the forecasting and provisioning procedures for Interconnection provided under this RIO Agreement.
- 1.2 Schedule 1A and 1B contain the details on the Network interface requirements and specifications for Interconnection between SingTel's Network and the Requesting Licensee's Network. Schedule 1A details the requirements for Physical or Virtual Interconnection for a Requesting Licensee who is an FBO for Interconnection to SingTel's Interconnect Gateway Switches, while Schedule 1B details the requirements for Virtual Interconnection for SBOs for Interconnection to SingTel's SBO Gateway Switches.
- 1.3 If the Requesting Licensee is an FBO, the Parties will comply with Schedule 1A.
- 1.4 If the Requesting Licensee is an SBO, the Parties will comply with Schedule 1B.
- 1.5 If SingTel requires Physical Interconnection or Virtual Interconnection with the Requesting Licensee, the Requesting Licensee will provide such interconnection on reciprocal terms and conditions to those set out in this Schedule 1.

SCHEDULE 1A

PHYSICAL AND/OR VIRTUAL INTERCONNECTION FOR FBOs

SCHEDULE 1 – CONTENTS

SCHEDULE 1 - PHYSICAL AND VIRTUAL INTERCONNECTION

SCHEDULE 1A - PHYSICAL AND/OR VIRTUAL INTERCONNECTION FOR FBOS

1. GENERAL	1
2. INTERCONNECT CONFIGURATION	1
3. POINT OF INTERCONNECTION	4
4. ALTERNATIVE INTERCONNECT CONFIGURATIONS AND POINTS OF INTERCONNECTION	5
5. PHYSICAL INTERCONNECTION	6
6. VIRTUAL INTERCONNECTION	8
7. TECHNICAL REQUIREMENTS AND SPECIFICATIONS	9
8. FORECASTING AND PROVISIONING OF INTERCONNECT CAPACITY	11
9. DECOMMISSIONING	17

SCHEDULE 1B - VIRTUAL INTERCONNECTION FOR SBOS

1. GENERAL	1
2. INTERCONNECT CONFIGURATION	1
3. POINT OF INTERCONNECTION	3
4. TECHNICAL REQUIREMENTS AND SPECIFICATIONS	4
5. DELIVERY OF INTERCONNECT CAPACITY	5
6. DECOMMISSIONING	6

SCHEDULE 1 - ANNEXURES

1. TESTING PRINCIPLES	25
2. PRE-REQUISITES FOR INTERCONNECT TESTING	25
3. TESTING ITEMS	26
4. TIMELINE FOR TESTING	26
5. DAILY TIME TABLE FOR INTERCONNECT TESTING	27
6. TESTING RESULTS	27
7. CHARGES FOR INTERCONNECT TESTING	28
8. CANCELLATION AND DELAY IN TESTING	28

SECTION 2B : SS7 MTP LEVEL 3 TEST SPECIFICATION – Q.782 RECOMMENDATION	42
1. INTRODUCTION	61
2. FAULT HANDLING PROCEDURES	61
3. PLANNED ENGINEERING WORKS	68
4. TESTING AND MONITORING	68

SCHEDULE 1A

PHYSICAL AND/OR VIRTUAL INTERCONNECTION FOR FBOS

CLAUSE 1 - MODIFICATION REQUIRED

1. GENERAL

CLAUSE 1.1 – CONDITIONAL APPROVAL

- 1.1 Each Party agrees to interconnect and keep interconnected their respective Networks subject to and in accordance with the terms and conditions of this Schedule 1A.

CLAUSE 1.2 - MODIFICATION REQUIRED

- 1.2 The Requesting Licensee will notify SingTel whether it requires Physical Interconnection or Virtual Interconnection under this Schedule. If there is insufficient Co-Location Space at a SingTel Co-Location Site to permit Physical Interconnection, SingTel shall provide Virtual Interconnection under this Schedule 1A to the Requesting Licensee. The determination of whether sufficient Co-location Space exists will be made pursuant to the terms and conditions specified in Schedule 8A.

For the avoidance of doubt, Clause 1.2 should be modified to state that the determination of whether sufficient co-location space exists will be made pursuant to the standards specified in Schedule 8, which sets forth SingTel's offer to provide co-location.

SingTel comments: Agreed.

CLAUSE 1.3 - CONDITIONAL APPROVAL

- 1.3 The provisions of this Schedule 1A apply to both Physical Interconnection and Virtual Interconnection, unless otherwise indicated.

CLAUSE 1.4 - CONDITIONAL APPROVAL

- 1.4 This Schedule 1A only applies to a Requesting Licensee which is an FBO.

CLAUSE 2 - MODIFICATION REQUIRED

2. INTERCONNECT CONFIGURATION

Sub-section 5.3.5.2 of the Code provides that the Dominant Licensee must offer to allow the physical linking of networks at any technically feasible point. Sub-section 2.2 of Appendix Two of the Code specifies three points of interconnection that IDA has

determined are always technically feasible: the interconnect gateway switch; Signalling Transfer points; and Local Switches (Line Side and Trunk Side). The RIO should contain specific provisions governing the prices, terms and conditions on which SingTel will provide physical (or, if not available, virtual) interconnection at the IGS, Signalling Transfer points and Local Switches (Line Side and Trunk Side). The RIO should also describe the procedures by which a Requesting Licensee can subsequently request interconnection at other locations.

SingTel comments: Refer to SingTel's comments in response to IDA's schedule A comments. A new clause 4 has been inserted to cater for the addition of alternative interconnect configurations and/or points of interconnect.

- 2.1 The Requesting Licensee must interconnect its Network with the SingTel Network at SingTel's Interconnect Gateway Switches (**IGS**) as specified in Section 2E of Annex A.
- 2.2 SingTel's Network is divided into two (2) zones, with East IGS and Hougang IGS serving the East zone and the City IGS and Geylang IGS serving the West zone.
- 2.3 Both Parties' Networks shall interface at IGS level.
- 2.4 The provision of Interconnection Links shall take into consideration the need for diversity and security in traffic routes and signalling links.
- 2.5 Unless otherwise agreed and subject to clause 2.6, the Requesting Licensee must interconnect its Network with the SingTel Network, whether by way of Physical Interconnection or Virtual Interconnection, at SingTel's four (4) IGS.
- 2.6 If the Requesting Licensee wishes to adopt an alternative interconnect configuration with its Network interconnecting at only two (2) SingTel IGS, the Requesting Licensee may only do so with SingTel's agreement and must be prepared to accept a performance level which is different to that applicable to Interconnection at SingTel's four (4) IGS.
- 2.7 Initially, the Requesting Licensee shall interconnect only one of its IGS(s) to any given SingTel IGS. Any subsequent Interconnection of another Requesting Licensee IGS to that SingTel IGS is subject to mutual agreement.
- 2.8 The Minimum Interconnection Capacity for Interconnection by the Requesting Licensee to a SingTel IGS is two (2) 2Mbps E1 links. The Minimum Interconnection Capacity for Interconnection by the Requesting Licensee to four (4) of SingTel IGSs is eight (8) 2Mbps E1 links.

2.9 If the Requesting Licensee interconnects to SingTel’s Network with Interconnect Capacity less than the Minimum Interconnection Capacity, the Requesting Licensee acknowledges that the Network performance may not be equivalent to other Licensees which have fulfilled the Minimum Interconnection Capacity for Interconnection to four (4) SingTel IGSs. SingTel shall not be liable for any degradation in Call handling and/or Network performance experienced by the Requesting Licensee who does not fulfil the Minimum Interconnection Capacity.

2.10 An Interconnection Link may comprise different types of circuit groups. The circuits in each circuit group will convey traffic in a specific direction (one-way) as shown below.

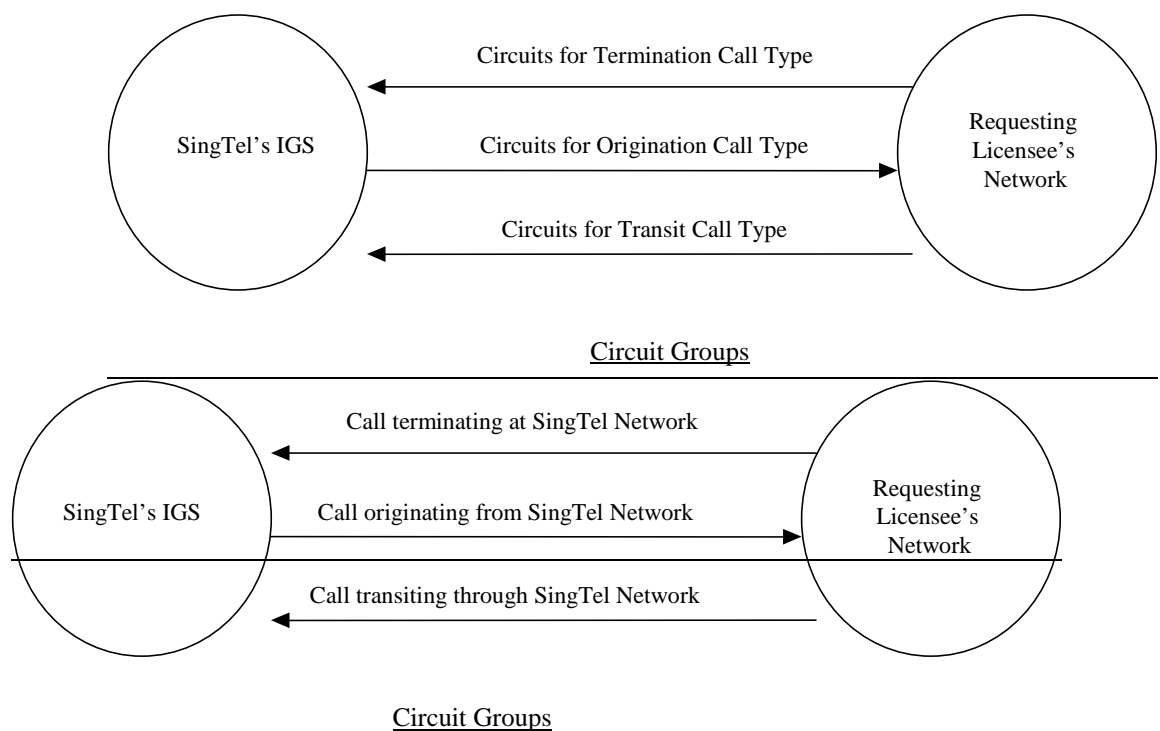

2.11 If SingTel or the Requesting Licensee wish to interconnect their respective Networks at additional IGSs, that Party may request an additional POI and the Parties will negotiate in good faith in relation to the interconnect configuration applicable to such additional Interconnection.

2.12 Neither Party shall be required to commence work on the installation of Network Facilities to support a new POI under clause 2.11 until the Parties have agreed on the interconnect configuration to apply under clause 2.11.

CLAUSE 3 - MODIFICATION REQUIRED

3. POINT OF INTERCONNECTION

CLAUSE 3.1 - MODIFICATION REQUIRED

3.1 The Parties agree that the POI will be located on the Requesting Licensee's side of the SingTel IGS Digital Distribution Frame (DDF) at the SingTel IGS as specified in section 2B of Annex A, determined by the following criteria:

- (a) if the Parties establish two Interconnection Links, the first link to carry SingTel's traffic and the second link to carry the Requesting Licensee's traffic, the POI for each link may be established at the Digital Distribution Frame (DDF) (or comparable equipment) of the Party providing the Call Origination, Call Termination and Call Transit service; or
- (b) if the Parties establish only one Interconnection Link to carry each Party's traffic to the other Party's Network, the POI may be at a notional mid-point of the Interconnection Link; or
- (c) the POI may be established at such other interconnection configurations as the Parties may agree on.

As noted above, SingTel must modify the RIO to offer interconnection at IGS, Signalling Transfer Points and Local Switches (Line Side and Trunk Side).

In addition, SingTel must modify the proposed RIO to provide that the Requesting Licensee may select from among the following interconnection configurations:

- (a) if the Licensees establish two interconnection links, the first link to carry SingTel's traffic to the Requesting Licensee's network and the second link to carry the Requesting Licensee's traffic to SingTel's network, the POI for each link may be established at the Distribution Frame (or comparable equipment) of the Licensee transiting or terminating the call; or*

SingTel comments: Agreed, subject to drafting above.

- (b) if the Licensees establish only one interconnection link to carry each Licensee's traffic to the other Licensee's network, the POI may be at a notional mid-point of the interconnection link; or*

SingTel comments: Agreed.

- (c) the POI should be established at such other interconnection configurations as the Licensees may agree on.*

SingTel comments: Agreed.

CLAUSE 3.2 - CONDITIONAL APPROVAL

- 3.2 Each Party is responsible for the provisioning and maintenance of Network Facilities (including those Network Facilities which form part of the Interconnect Links and the transmission equipment) on its “side” of the POI.

CLAUSE 3.3 - CONDITIONAL APPROVAL

- 3.3 The cost of the installation, maintenance and operation of the Network Facilities on each Party’s side of the POI which form part of the Interconnect Link(s) shall be borne by that Party.

CLAUSE 3.4 - CONDITIONAL APPROVAL

- 3.4 Each Party will ensure that its Network Facilities which form part of the Interconnection Link(s) are provisioned and maintained with Interconnect Capacity in accordance with the ordered Capacity under this Schedule 1A.

4. ALTERNATIVE INTERCONNECT CONFIGURATIONS AND POINTS OF INTERCONNECTION

- 4.1 The Requesting Licensee may request alternative interconnect configurations and locations for the POI as specified in the COP.

- 4.2 On receipt of a request under clause 4.1 in respect of an alternative interconnect configuration or POI location specified in the COP, SingTel and the Requesting Licensee will promptly discuss the Requesting Licensee’s request.

- 4.3 If, thirty (30) Business Days after the receipt of a request under clause 4.1 and following discussions under clause 4.2, the Requesting Licensee wishes to pursue the alternative interconnect configuration or POI, SingTel will commence the formulation of terms and conditions to incorporate in this RIO Agreement.

- 4.4 SingTel will submit terms and conditions to the Authority for approval and incorporation into the RIO and this RIO Agreement within sixty (60) Business Days after the receipt of a request under clause 4.1. Alternatively, SingTel may seek an exemption from the relevant aspects of the COP.

CLAUSE 5 (FORMERLY CLAUSE 4) – MODIFICATION REQUIRED

SingTel must make clear that Figure 1 depicts only one possible interconnection configuration.

SingTel comments: Agreed.

4.5. PHYSICAL INTERCONNECTION

4.15.1 Figure 1 depicts a possible configuration of the Physical Interconnection of the Interconnection Links between SingTel's Network and the Requesting Licensee's Network and the location of the POI.

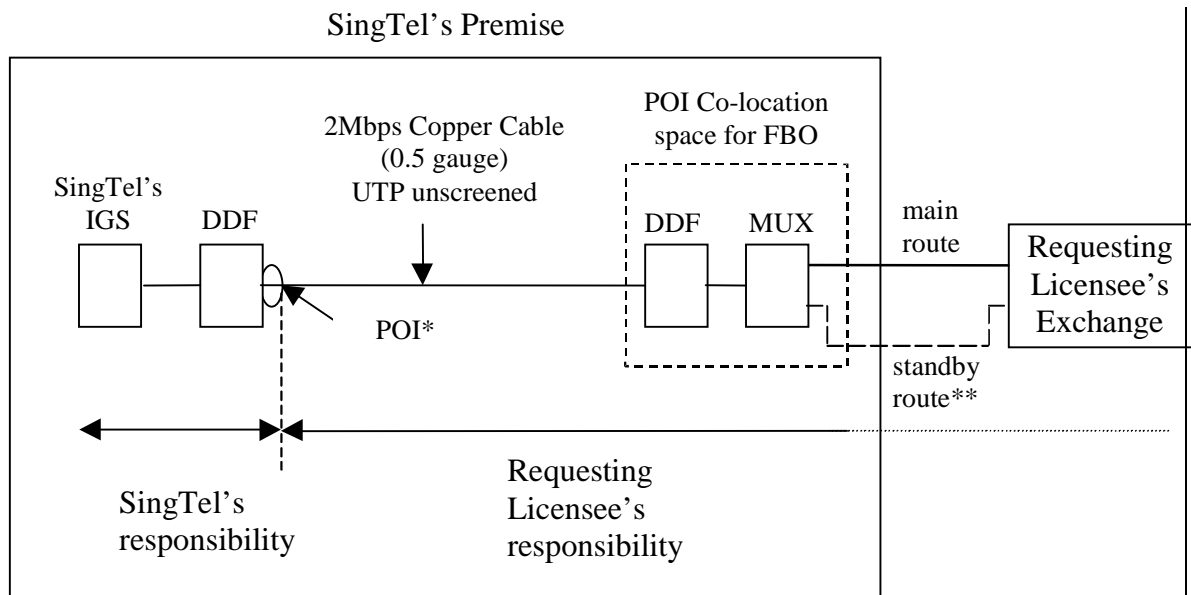

* dictates the responsibilities of each Party on its side of the POI
 ** when applicable

Figure 1: FBO Physical Interconnection

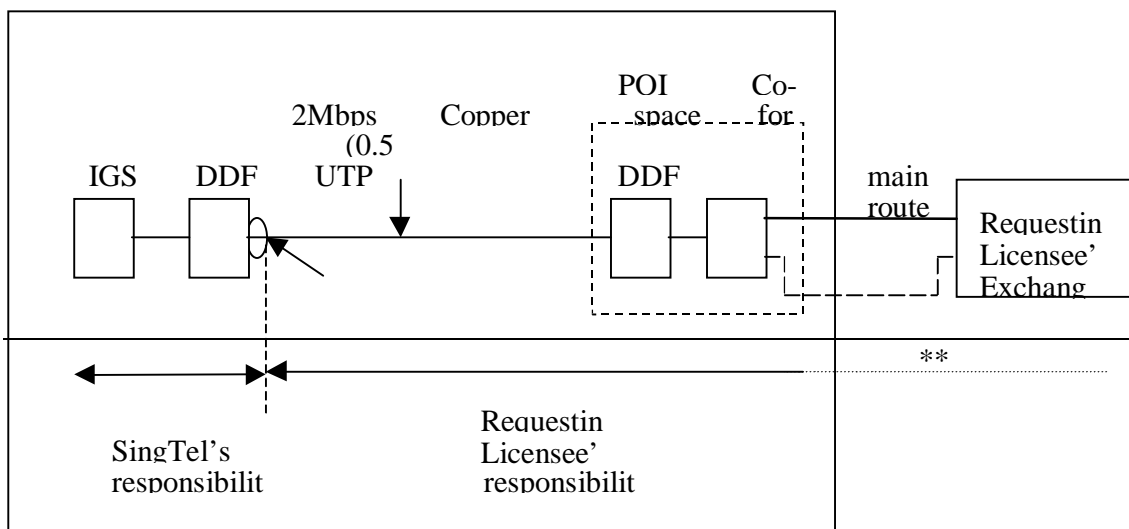

* dictates the responsibilities of each Party on its side of the POI
 ** when applicable

Figure 1: FBO Physical Interconnection

4.25.2 The provisions in Schedule 8 will apply to access to and co-location of Co-Location Equipment at SingTel's IGS for Physical Interconnection.

CLAUSE 6 (FORMERLY CLAUSE 5) – MODIFICATION REQUIRED

SingTel must make clear that Figure 2 depicts only one possible interconnection configuration.

SingTel comments: Agreed.

5.6. VIRTUAL INTERCONNECTION

5.16.1 Figure 2 depicts a possible configuration of the Virtual Interconnection between SingTel's Network and the Requesting Licensee's Network and the location of the POI.

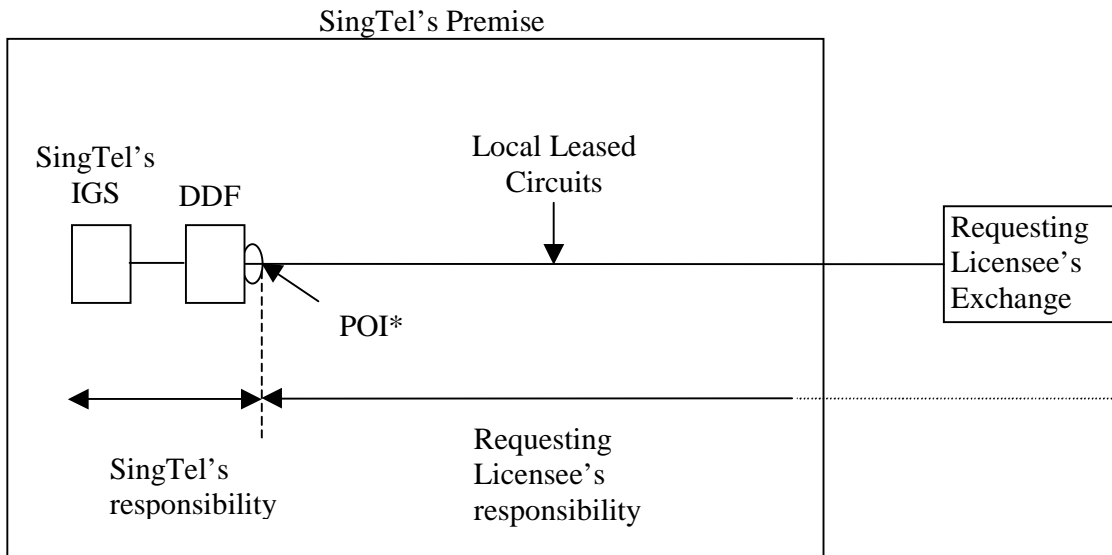

* dictates the responsibilities of each party on its side of the "POI"

Figure 2: FBO Virtual Interconnection

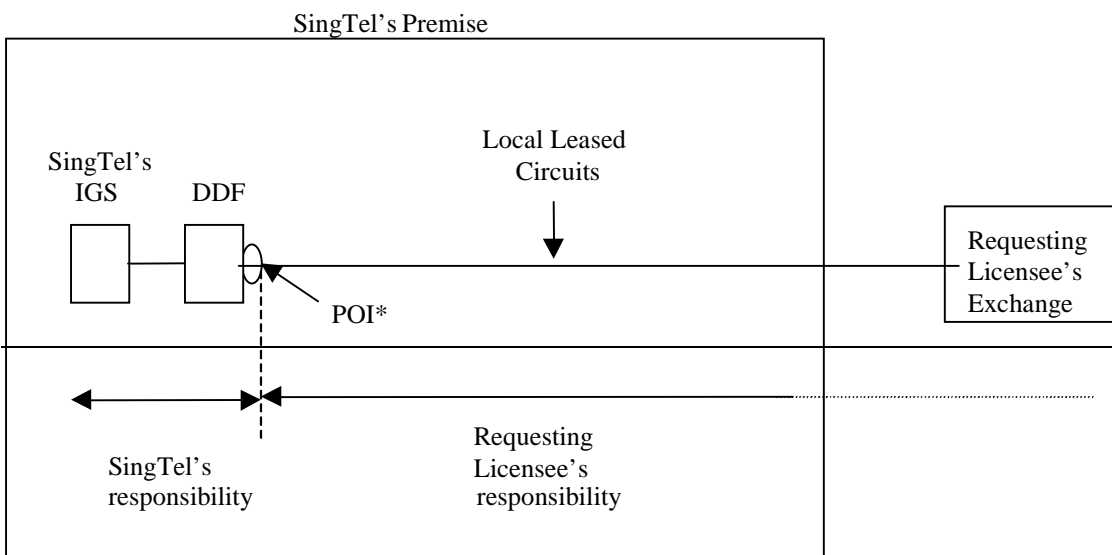

* dictates the responsibilities of each party on its side of the "POI"

Figure 2: FBO Virtual Interconnection

CLAUSE 6.2 (FORMERLY CLAUSE 5.2) – MODIFICATION REQUIRED

5.26.2 The Requesting Licensee shall acquire Local Leased Circuits from SingTel to form part of the Interconnection Link. The Requesting Licensee's leased Interconnection Link shall consist of multiple 2 Mbit/s (E1) circuits terminated at a DDF in SingTel's IGS.

Where the Requesting Licensee that receives virtual interconnection is a Facilities-based Licensee, SingTel must allow the Licensee to: (a) obtain the Local Leased Circuit from SingTel or (b) self-provision the Local Leased Circuit. See Code Appendix Two § 2.3.

SingTel comments: Not agreed to paragraph (b). Physical Interconnection is provided for Requesting Licensee's self provisioning. Virtual interconnection is provided where the Interconnect Link is to be provided by SingTel in the form of a leased circuit. Also, the proposed clause is consistent with the Code Appendix 2 section 2.3, in which the Requesting Licensee is to bear the cost of the link.

5.36.3 On the Requesting Licensee's request, SingTel will lease Local Leased Circuits at 2Mbps (E1) G.703 interface to the Requesting Licensee's Network based on SingTel's standard terms and conditions for supply of Local Leased Circuit service.

CLAUSE 7 (FORMERLY CLAUSE 6) – CONDITIONAL APPROVAL, EXCEPT SUB-CLAUSE 7.25

6.7. TECHNICAL REQUIREMENTS AND SPECIFICATIONS

6.17.1 Transmission

6.1.17.1.1 The Parties' shall interface at 2Mbps level and comply with ITU-T Rec G.703.

6.27.2 Signalling

6.2.17.2.1 The Parties shall comply with the Common Channel Signalling (CCS) No.7 Signalling System – Message Transfer Part (MTP) and ISDN User Part as specified in Section 1 of Annex A.

6.2.27.2.2 The Requesting Licensee shall obtain its own Signalling Point Code from the Authority.

6.2.37.2.3 The Parties' IGS shall interwork on associated mode of signalling for the establishment of Interconnected Calls between the Parties Network.

6.2.47.2.4 Both Parties shall provide CCS No. 7 Signalling System (SS7) Signalling Linkset comprising of two (2) SS7 Signalling Links on each Interconnect Link.

CLAUSE 7.2.5 (FORMERLY CLAUSE 6.2.5) – MODIFICATION REQUIRED

SingTel must modify sub-clause 6.2.5 to impose a mutual obligation on SingTel and the Requesting Licensee to comply with SS7.

SingTel comments: Agreed.

~~6.2.5~~**7.2.5** ~~The Requesting Licensee~~Parties shall adhere to additional SS7 signalling requirement as follows:

- (a) The Calling Party Number and Redirecting Number if available shall be conveyed for all calls across the Network Interconnection without manipulation;
- (b) The Dummy CLI received from Mobile Operators from inbound and outbound roamers shall be an eight (8) digit Dummy CLI;
- (c) The number dialled by the calling subscriber shall not be changed or amended for the routing of international outgoing calls from ~~the Requesting Licensee~~one Party's Network to ~~SingTel's IGS~~the other Party's Network. In addition, the Nature of Address (**NOA**) of the Called Party Number shall be set to 'International';
- (d) ~~the Requesting Licensee~~Each Party's Network shall deliver international incoming Calls to ~~SingTel's IGS~~the terminating to SingTel's terminating Party's Network with the international Call indicator 'A' bit of FCI parameter of the IAM set to '1'.

~~6.3~~**7.3** **Synchronisation**

~~6.3.4~~**7.3.1** ~~The Parties shall interwork with each other on plesiochronous mode of synchronisation.~~

~~6.4~~**7.4** **Routing**

~~6.4.4~~**7.4.1** ~~The Parties shall route Interconnected Calls in accordance with the agreed arrangements applicable to that Call Type under Schedule 2.~~

~~6.5~~**7.5** **Interconnect Testing**

~~6.5.4~~**7.5.1** ~~The Parties shall comply with the testing procedures in Section 1A of Annex A.~~

CLAUSE 8 (FORMERLY CLAUSE 7) – MODIFICATION REQUIRED

SingTel must modify Clause 7 in the manner specified in Paragraph 7 of Schedule A.

SingTel comments: Agreed, except paragraph (e) of paragraph 7 of Schedule A regarding remedy damages. Delivery of forecast capacity is a two way process as described in our comments in response to IDA's comments.

7.8. FORECASTING AND PROVISIONING OF INTERCONNECT CAPACITY

CLAUSE 8.1 (FORMERLY CLAUSE 7.1) – MODIFICATION REQUIRED

7.18.1 (a) ~~This Section 8.2 to 8.14 applies to Forecasts to be provided by the Requesting Licensee each Party (the Forecasting Party) to SingTel in relation to Interconnect Capacity, if the Requesting Licensee Forecasting Party reaches a minimum Interconnect Capacity of sixty-three (63) E1s for Interconnection with the SingTel Other Party's (the Supplying Party) Network.~~

(b) Where Interconnect Capacity is below sixty-three (63) E1s each Party shall provide the Interconnect Capacity without the need for a forecast. Each Party (Requesting Party) shall apply for the Interconnect Capacity under clause 8.15.

SingTel must confirm that it will meet any request for fewer than 63 E1 without a forecast.

SingTel comments: See new ordering process for capacity requirements below 63 E1s in clause 8.15.

CLAUSE 8.2 (FORMERLY CLAUSE 7.2) – MODIFICATION REQUIRED

~~**7.28.2** On or near 1 February and 1 August of each year, the Requesting Licensee will advise SingTel of its estimates of the total number of lines or Subscribers in service on 1 April and 1 October in that year and each subsequent year for three (3) years.~~

This Clause is unreasonable because it requests unnecessary and commercial sensitive information. Therefore, IDA requires Clause 7.2 to be deleted. The Requesting Licensee need only forecast the amount of Interconnect Capacity that it will require.

SingTel comments: Agreed.

CLAUSE 8.3 (FORMERLY CLAUSE 7.3) – MODIFICATION REQUIRED

SingTel must modify this Clause to state that it will comply with the same procedure when it seeks to obtain Interconnect Capacity from a Requesting Licensee.

SingTel comments: Agreed if more than 63 E1s for SingTel Traffic.

~~7.38.3~~ The ~~Requesting Licensee~~ Forecasting Party shall provide to ~~SingTel~~ the Supplying Party the Forecasts for Interconnect Capacity on or near 1 March and 1 September of each year and in the formats in Annex 1A-1.

CLAUSE 8.4 (FORMERLY CLAUSE 7.4) – CONDITIONAL APPROVAL

~~7.48.4~~ The Forecasts shall be for periods commencing six (6) months from 1 April and 1 October (**Forecast Date**) respectively, and be for a period of thirty-six (36) months, in intervals of six (6) months for the first twelve (12) months, and yearly thereafter.

CLAUSE 8.5 (FORMERLY CLAUSE 7.5) – MODIFICATION REQUIRED

~~7.58.5~~ ~~SingTel~~ The Supplying Party will respond to a Forecast within fifteen (15) Business Days, ~~or any other period as may be agreed~~, of receipt, or such other period as may be agreed. The response shall be either:

- (i) an acknowledgment that the Supplying Party ~~SingTel~~ is able to provide the Forecasted Interconnect Capacity in the first six (6) month period by a particular date (**Forecast Delivery Date**); or
- (ii) an acknowledgment that the Supplying Party ~~SingTel~~ is able to provide the Forecasted Interconnect Capacity in the first six (6) month period, but not be able to provide those quantities in accordance with the Forecast timeframes; or
- (iii) an advice that the Supplying Party ~~SingTel~~ is unable to provide the Forecasted Interconnect Capacity in the first six (6) month period as procurement is required.

The 15 Business Day period specified is unreasonably long and would delay the provision of competitive telecommunications services. SingTel must shorten this period. IDA believes that a period of 10 Business Days would be reasonable. In the event that SingTel reverts otherwise than accepting the Requesting Licensee's forecast, the Requesting Licensee must be given a right to invoke the dispute resolution procedures. Pending resolution, SingTel shall provide the portion of the requested Interconnect Capacity that it agrees is reasonable.

SingTel comments: Not Agreed. This period is not unreasonable, especially in a multi-operator environment and will not delay the provisioning. It is the period for responding to a forecast and not provisioning.

CLAUSE 8.6 (FORMERLY CLAUSE 7.6) – MODIFICATION REQUIRED

~~7.68.6~~ Where procurement is required in order to meet the Forecast, and the Supplying Party~~SingTel~~ advises the Forecasting Party~~Requesting Licensee~~ pursuant to clause ~~78.45~~, the Supplying Party~~SingTel~~ shall seek confirmation of the Forecast from the Forecasting Party. Upon confirmation by the Forecasting Party, the Supplying Party shall complete the procurement no later than it would complete such procurement for itself~~As a general guide, the provisioning time is twelve (12) months from the Forecast Date.~~

IDA considers a twelve-month provisioning period to be unreasonably long and must be shortened. A Licensee must provide the capacity in the shortest commercially reasonable time, which shall not be longer than the time the Licensee takes to procure capacity for itself and its affiliates. See Code §§ 4.2.3 & 5.3.5.1.

SingTel comments: Agreed. See clause 8.6 for revised wording.

CLAUSE 8.7 (FORMERLY CLAUSE 7.7) – MODIFICATION REQUIRED

~~7.78.7~~ If the Requesting Licensee~~Forecasting Party~~ seeks Interconnect Capacity at a level other than the Forecast level or on a Forecast Delivery Date other than the agreed Forecast Delivery Date, it may make a request to the Supplying Party ~~SingTel~~ to ~~study the feasibility of such a request~~provide the revised level of capacity or revise the Forecast Delivery Date. Where necessary, the Supplying Party ~~SingTel~~ ~~shall~~may undertake a feasibility study within thirty (30) Business Days, and the Requesting Licensee~~Forecasting Party~~ shall pay a fee to the Supplying Party ~~SingTel~~ ~~for to~~recover the reasonable costs involved in the conduct of the study in response to the request.

Any effort to use the feasibility study to impose delay or impose unnecessary costs on a Requesting Licensee would be unreasonable and, therefore, in contravention of the Code. SingTel must make clear that it will only conduct a feasibility study when, and to the extent, necessary. In addition, SingTel will provide for a timeframe by which it will conclude any necessary feasibility study. Finally, SingTel must provide that the fee for conducting the feasibility study is limited to the reasonable cost of undertaking the study.

SingTel comments: Agreed.

CLAUSE 8.8 (FORMERLY CLAUSE 7.8) – CONDITIONAL APPROVAL

~~7.88.8~~ ~~SingTel~~The Supplying Party is under no obligation to provide Interconnect Capacity other than in accordance with the accepted Forecast Capacity requirements and the accepted Forecast delivery times. Where there is a dispute as to Forecast Capacity requirements, the Supplying Party shall provide that level of Interconnection Capacity that it considers reasonable pending resolution of the dispute under Schedule 11.

CLAUSE 8.9 (FORMERLY CLAUSE 7.9) – CONDITIONAL APPROVAL

~~7.98.9~~ Clauses ~~78.67~~ and ~~78.78~~ are not intended to create a process in substitution for the normal Forecasting process.

CLAUSE 8.10 (FORMERLY CLAUSE 7.10) – MODIFICATION REQUIRED

~~7.108.10~~ The ~~Requesting Licensee~~ Forecasting Party agrees that:

- (a) the first six (6) months of each Forecast given by it is a commitment for the full quantity of Interconnect Capacity which ~~SingTel~~ the Supplying Party will necessarily supply or install in order to meet that Forecast; and
- (b) it will pay ~~all~~ any Charges calculated in accordance with ~~Schedule 9~~ relating to its failure to utilise the full quantity of Interconnect Capacity in relation to a ~~Forecast~~ clause 8.13; and
- (c) there shall be no variation in the Forecasts as provided to the Supplying Party ~~SingTel~~.

This Clause appears to be inconsistent with Clause 7.13. SingTel must modify both of these Clauses to be consistent with Paragraph 7 of Schedule A.

SingTel comments: In the drafting, we have tied 8.10(b) to 8.13.

CLAUSE 8.11 (FORMERLY CLAUSE 7.11) – MODIFICATION REQUIRED

~~7.118.11~~ If, following acceptance of a Forecast, the Supplying Party ~~SingTel~~ is unable to provide the Interconnect Capacity or provide the Interconnect Capacity by the Forecast Delivery Date, in whole or part, it must advise the ~~Requesting Licensee~~ Forecasting Party promptly and both Parties must, where practicable, negotiate a new delivery timetable. To assist in this negotiation, the Supplying Party ~~SingTel~~ may offer alternatives where available.

Once SingTel, either at the outset or following a Dispute Resolution, has accepted a Forecast, SingTel shall be under an obligation to deliver Interconnect Capacity in accordance with the Forecast. Any failure to do so will constitute a breach of the RIO Agreement. SingTel must specify a remedy when it provisions less than 80 percent of the agreed upon forecast capacity. See Code § 5.3.2(m).

SingTel comments: As earlier described, delivery of forecast capacity is a two-way process (eg access, delivery, testing etc). SingTel considers this clause to be reasonable. See clause 18.14.2 in relation to late delivery of leased circuits for virtual interconnection which would be within SingTel's control.

CLAUSE 8.12 (FORMERLY CLAUSE 7.12) – MODIFICATION REQUIRED

7.128.12 Delivery of Forecast Capacity

~~7.12.48.12.1~~ The Parties shall use their reasonable endeavours to ensure that its Network Facilities on its side of the relevant POI are provisioned on the Forecast Delivery Date (or as otherwise agreed) and maintained in accordance with the Forecasts.

~~7.12.2~~ Delivery of Interconnect Capacity is taken to occur on the Forecast Delivery Date or on such other date as may be agreed (as applicable) provided that the Supplying Party SingTel has advised that it is ready to commence testing.

The imposition of charges for a service that is not being provided is commercially unreasonable and therefore a contravention of the Code. SingTel must clarify that it does not intend to charge for Interconnect Capacity prior to the date on which testing determines that it is operational.

SingTel comments: There is no charge for Interconnect Capacity. Recovery for over-forecasting is for the purpose of cost recovery of network elements provisioned from the POI within the SingTel network necessary to convey calls for origination, termination and transit services.

CLAUSE 8.13 (FORMERLY CLAUSE 7.13) – MODIFICATION REQUIRED

8.13 Recovery for Over Forecasting

~~7.13.48.13.1~~ If the Actual Usage by the Requesting Licensee Forecasting Party of the Interconnect Capacity is greater than or equal to ~~ninety-eighty~~ (890) percent of its Forecast, no over forecasting Charges shall apply.

~~7.13.28.13.2~~ If the Actual Usage by the Requesting Licensee Forecasting Party of the Interconnect Capacity is less than ~~ninety-eighty~~ (890) percent of its Forecast, the Requesting Licensee Forecasting Party shall pay the amount calculated in accordance with Schedule 9 until such time as Actual Usage reaches ~~ninety-eighty~~ (890) percent.

Given the importance of ensuring the provision of adequate Interconnect Capacity, the proposed 90 percent “trigger” for the payment of over-forecasting Charges is unreasonable. SingTel must reduce the “trigger” to 80 percent.

SingTel comments: Agreed.

~~7.13.38.13.3~~ Where a dispute arises in respect to the Actual Usage under this clause ~~78.123~~, the matter will be referred for resolution in accordance with Schedule 11 – Dispute Resolution.

CLAUSE 8.14 (FORMERLY CLAUSE 7.14) – MODIFICATION REQUIRED

7.148.14 Virtual Interconnection

7.14.48.14.1 Notwithstanding anything else in this clause 78, the Requesting Licensee remains responsible for Forecasting and ordering sufficient Capacity on Local Leased Circuits under SingTel's standard terms and conditions to enable Virtual Interconnection to occur.

As noted above, SingTel cannot require Facilities-based Licensees that select virtual interconnection to order Leased Circuits from SingTel.

SingTel comments: Not agreed. As above, self provisioning is already catered for under Physical Interconnection.

8.14.2 SingTel will pay such damages to the Requesting Licensee for late delivery of Interconnect Capacity on the Local Leased Circuits to be supplied by SingTel to the Requesting Licensee in accordance with the SingTel standard Local Leased Circuits agreement. The Requesting Licensee acknowledges that the damages payable under this clause 8.13.2 are a genuine estimate of the Requesting Licensee's direct loss in connection with the late delivery of the Interconnect Capacity on the Local Leased Circuits and the payment of such damages shall be SingTel's sole liability to the Requesting Licensee in respect of the late delivery of the Interconnect Capacity on the Local Leased Circuits.

8.15 Ordering and Provisioning Procedure for Interconnect Capacity Without Forecast

8.15.1 The Requesting Party shall submit its Request for Interconnect Capacity Without Forecast to the Supplying Party in the form of Annex 1B.

8.15.2 The Supplying Party shall process all Requests for Interconnect Capacity Without Forecast on a 'first come, first served' basis.

8.15.3 The Supplying Party shall respond to a Request of Interconnect Capacity Without Forecast within fifteen (15) Business Days, or any other period as may be agreed, of receipt of such Request, or such other period as may be agreed. The response shall be either:

(a) an acknowledgement that the Supplying Party is able to provide the full Interconnect Capacity Without Forecast by the **Required Date**

(b) an acknowledgement that Supplying Party is able to provide the Interconnect Capacity Without Forecast, but not be able to provide the quantities by the **Required Date**; or

(c) an advice that the Supplying Party is unable to provide the Interconnect Capacity Without Forecast as procurement is required.

8.15.4 When procurement is required in order to meet the Request, and the Supplying Party advises the Requesting Party pursuant to clause 8.15.3, the Supplying Party shall seek confirmation of the required Capacity from the Requesting Party. Upon confirmation, the Supplying Party shall complete the procurement no later than it would complete such procurement for itself.

CLAUSE 9 (FORMERLY CLAUSE 8) - MODIFICATION REQUIRED

8.9. DECOMMISSIONING

CLAUSE 9.1 (FORMERLY CLAUSE 8.1) - MODIFICATION REQUIRED

8.19.1 Subject to clauses 89.2 and 89.3, a Party (**Decommissioning Party**) may, for whatever reason upon giving no less than six (6) months prior written notice to the other Party (**Decommissioning Period**), close, replace or relocate any IGS in respect of which an Interconnection Link is connected, decommission an Interconnection Link or close a POI- (**Decommissioning**).

As it is in the public's interest to ensure the continual interconnection of networks, SingTel must modify Clause 8.1 to provide that, notwithstanding the expiry of any notice period, any:

- (a) *decommissioning of an Interconnect Link can only take place after a substitute Interconnection Link has been commissioned;*
- (b) *closure, replacement or relocation of the IGS can only take place after a substitute IGS has been identified or established; and*
- (c) *closure of a POI can only take place after a substitute POI has been identified or established.*

SingTel comments: SingTel has responded to this issue in our response to IDA's comments. Reasonable alternatives can be offered by SingTel but SingTel must be able to proceed with the Decommissioning if the Requesting Licensee has chosen not to accept an alternative given to it. The 6 month notice period is adequate for the Requesting Licensee to check and implement alternative arrangements. See process in clause 9.3.

CLAUSE 9.2 (FORMERLY CLAUSE 8.2) - MODIFICATION REQUIRED

8.29.2 (a) Subject to paragraph (b), the Decommissioning Party shall be responsible for and bear all direct costs incurred by both Parties in carrying out the Decommissioning. Direct costs are limited to removal of equipment and cabling at the POI or IGS. Each Party will bear its own costs of recovering its own part of the Interconnection Link.

(b) When the request for Decommissioning is at the direction of a Third Party pursuant to a legal obligation binding on the Decommissioning Party, each Party shall bear its own costs associated with the Decommissioning together with the direct costs incurred by that Party in respect of the establishment of alternative arrangements necessary to support the provision of Call Origination, Call Transit and Call Termination Services provided at the time of the Decommissioning.

SingTel appears to have inadvertently failed to include Call Transit in Clause 8.2(b).

SingTel comments: **Agreed.**

CLAUSE 9.3 (FORMERLY CLAUSE 8.3) - MODIFICATION REQUIRED

9.3 If Decommissioning is to occur where Physical Interconnection has been established, the Decommissioning Party will, if requested by the other Party within thirty (30) Business Days after receiving a notice under clause 9.1, offer alternative interconnection solutions no less than three (3) months prior to the expiry of the Decommissioning Period and discuss the implementation of such solutions with the other Party. Nothing in this clause prevents the Decommissioning from occurring on the expiry of the Decommissioning Period provided that the Decommissioning Party has complied with this clause 9.3.

CLAUSE 9.4 – CONDITIONAL APPROVAL

8.39.4 If Decommissioning is to occur where Virtual Interconnection has been established and:

(a) the Requesting Licensee is the Decommissioning Party, the Requesting Licensee must also comply with the terms and conditions under which Local Leased Circuits are supplied by SingTel (including the payment of any early termination payments); or

(b) SingTel is the Decommissioning Party, SingTel will offer to arrange for the connection of Local Leased Circuits to the alternative or relocated IGS; ~~Interconnection Link~~ or POI prior to the Decommissioning.

As noted above, SingTel cannot require a virtually interconnected Facilities-based Licensee to obtain Local Leased Circuits from SingTel. Therefore Clause 8.3 should be restricted to Services-based Licensees that obtain virtual interconnection or virtually interconnected Facilities-based Licensees that choose to obtain Local Leased Circuits from SingTel.

SingTel comments: Not agreed. As discussed above, Physical Interconnection is provided for Requesting Licensee's self provisioning.

8.49.5 Upon the happening of an event which causes or is likely to cause significant damage to the Network of a Party or which endangers or is likely to endanger the health or safety of any person (**Emergency Event**), that Party may close or replace its IGS or a POI or Decommission an Interconnection Link without prior written notice to the other Party, provided that it notifies the other Party as soon as practicable that the Emergency Event exists and that emergency relocation work is being or will be performed. The costs incurred as a result of, or in connection with, a closure or replacement of an IGS or a POI or decommissioning of an Interconnection Link under this clause 9 shall be borne as follows:

- (a) where the occurrence of the Emergency Event was caused as a result of the negligence or wilful act or omission of the first-mentioned Party, its employees, agents or contractors, that Party shall bear the costs associated with the closure, replacement or Decommissioning incurred by both Parties; and
- (b) where the occurrence of the Emergency Event was not caused as a result of the negligence or wilful act or omission of the first-mentioned Party, its employees, agents or contractors, each Party shall bear its own costs associated with the closure, replacement or Decommissioning.

ANNEX 1A – CONDITIONAL APPROVAL

ANNEX 1A – FORECASTING OF INTERCONNECT CAPACITY

Interconnect Capacity Forecasts shall be in accordance with clause 78 of Schedule 1A and include the maximum Interconnect Capacity required at each POI.

Interconnect Capacity Forecast for the Interconnect Link between _____ and _____ .				
Forecasting Period: From _____ to _____				
	Year 1		Year 2	Year 3
	First 6 months	Subsequent 6 months		
No. of outgoing E1s:				
No. of E1s for Origination Call Type				
No. of incoming E1s:				
No. of E1s for Termination Call Type				
No. of E1s for Transit Call Type				
No. of both way E1s:				
		Outgoing Circuits for Origination Call Type	Incoming Circuits for Termination Call Type	Both way Circuits for Transit Call Type
No. of E1s to be turned on in 1st month of Forecasting period:				
No. of E1s to be turned on in 2nd month of Forecasting period:				
No. of E1s to be turned on in 3rd month of Forecasting period:				
No. of E1s to be turned on in 4th month of Forecasting period:				
No. of E1s to be turned on in 5th month of Forecasting period:				

ANNEX 1B – INTERCONNECT CAPACITY WITHOUT FORECAST

<u>Request For Interconnect Capacity Without Forecast</u>			
<u>Name of Operator:</u>			
<u>Purchase Order No:</u>			
<u>Required By Date:</u>			
<u>Operator's Switch:</u>			
<u>SingTel's Switch:</u>			
	<u>Circuits for Origination Call Type</u>	<u>Circuits for Termination Call Type</u>	<u>Circuits for Transit Call Type</u>
<u>No. of E1s</u>			

SCHEDULE 1B
VIRTUAL INTERCONNECTION FOR SBOs

SCHEDULE 1B

VIRTUAL INTERCONNECTION FOR SBOS

CLAUSE 1 - CONDITIONAL APPROVAL

1. GENERAL

1.1 Each Party agrees to interconnect and keep interconnected their respective Networks subject to and in accordance with the terms and conditions of this Schedule 1B.

1.2 This Schedule 1B only applies to a Requesting Licensee which is an SBO.

CLAUSE 2 - CONDITIONAL APPROVAL

2. INTERCONNECT CONFIGURATION

2.1 The Requesting Licensee must interconnect its Network with the SingTel Network at SingTel's SBO Gateway Switches (SGS) as specified in Section 2F of Annex A.

2.2 The Requesting Licensee will ensure that the Interconnection Link(s) is provisioned and maintained with sufficient Interconnect Capacity

2.2.3 The Minimum Interconnection Capacity for Interconnection by the Requesting Licensee to a SingTel SGS is two (2) 2Mbps E1 links. The Minimum Interconnection Capacity for Interconnection by the Requesting Licensee to two (2) of SingTel SGS is four (4) 2Mbps E1 links.

2.32.4 If the Requesting Licensee interconnects to SingTel's Network with Interconnection Capacity less than the Minimum Interconnection Capacity, the Requesting Licensee acknowledges that the Network performance may not be equivalent to other Licensees which have fulfilled the Minimum Interconnection Capacity for Interconnection to two (2) of SingTel SGSs. SingTel shall not be liable for any degradation in Call handling and/or Network performance experienced by a Requesting Licensee who does not fulfil the Minimum Interconnection Capacity.

2.42.5 An Interconnection Link may comprise different types of circuit groups. The circuits in each circuit group will convey traffic in a specific direction (one-way) as shown below.

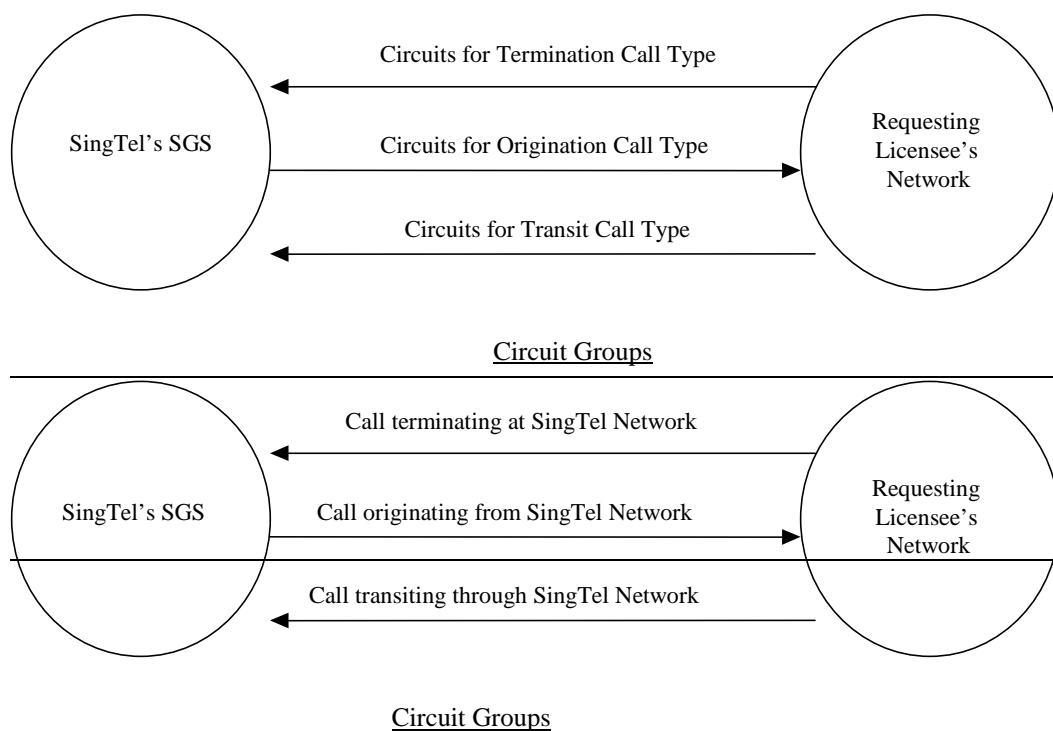

2.52.6 The Requesting Licensee is responsible for the correct dimensioning of the type of circuit groups (one-way) that it will require.

2.62.7 If SingTel or the Requesting Licensee wish to interconnect at additional POIs, that Party may request an additional POI and the Party will negotiate in good faith in relation to the interconnect configuration applicable to such additional Interconnection.

2.72.8 Neither Party shall be required to commence works on the installation of Network Facilities to support a new POI under clause 2.6-7 until the Party has agreed on the interconnect configuration under clause 2.67.

CLAUSE 3 - CONDITIONAL APPROVAL

3. POINT OF INTERCONNECTION

3.1 The Parties agree that the POI will be located on the Requesting Licensee's side of the SingTel SGS Digital Distribution Frame (**DDF**) at the SingTel SGS.

3.2 Each Party is responsible for the provisioning and maintenance of Network Facilities on its "side" of the POI.

- 3.3** The Interconnection between SingTel's SGS and the Requesting Licensee's Network located at a different site will be implemented by means of 2Mbps E1 Interconnection Link.
- 3.4** The Requesting Licensee will be responsible for connection of the Interconnection Link between the POI and the Requesting Licensee's Network.
- 3.5** The Requesting Licensee shall acquire Local Leased Circuits from SingTel to form part of the Interconnection Link. The Requesting Licensee's leased Interconnection Link consists of multiple 2 Mbit/s (E1) circuits terminated at a DDF in SingTel's designated SGS exchanges.
- 3.6** At the Requesting Licensee's request, SingTel will lease Local Leased Circuits at 2Mbps (E1) G.703 interface to the Requesting Licensee's Network based on SingTel's standard terms and conditions for supply of Local Leased Circuit service.

CLAUSE 4 – MODIFICATION REQUIRED

4. TECHNICAL REQUIREMENTS AND SPECIFICATIONS

4.1 Transmission

- 4.1.1** The Parties' shall interface at 2Mbps level and comply with ITU-T Rec G.703.

4.2 Signalling

- 4.2.1** The Parties shall comply with CCS SS7 – MTP and ISUP as specified in Section 1 of Annex A.
- 4.2.2** The Requesting Licensee shall obtain its own Signalling Point Code from the Authority.
- 4.2.3** Both Parties shall provide CCS SS7 Signalling Link(s) up to a maximum of two (2) SS7 Signalling Links for Interconnection to one (1) SGS (or POI) or a maximum of four (4) SS7 Signalling Links for Interconnection to two (2) SGSs.

CLAUSE 4.2.4 – MODIFICATION REQUIRED

SingTel must modify sub-clause 4.2.4 to impose a mutual obligation on SingTel and the Requesting Licensee to comply with SS7.

SingTel comments: Agreed.

4.2.4 The ~~Requesting Licensee~~ Parties shall adhere to additional SS7 signalling requirement as follows:

- (a) The Calling Party Number and Redirecting Number if available shall be conveyed for all Calls across the Network connection without manipulation.
- (b) The Dummy CLI received from Mobile Operators from inbound and outbound roamers shall be an eight (8) digit Dummy CLI.
- (c) The number dialled by the Calling subscriber shall not be changed or amended for the routing of international outgoing Calls from ~~the Requesting Licensee~~ one Party's Network to ~~SingTel's SGS~~ the other Party's Network. In addition, the NOA of the Called Party Number shall be set to 'International'.
- (d) ~~The Requesting Licensee~~ Each Party's Network shall deliver international incoming Calls to ~~SingTel's SGS terminating to SingTel~~ the terminating Party's domestic Network with the international Call indicator 'A' bit of FCI parameter of the IAM set to '1'.

4.3 Interconnect Testing – ~~Transmission and Signalling~~

4.3.1 The Parties shall comply with the testing procedures in Section 1A of Annex A.

4.4 Routing

4.4.1 The Parties shall route Interconnected Calls in accordance with the agreed arrangements applicable to that Call Type under Schedule 2.

~~4.4.2 The Parties shall comply with the testing procedures in Section 1A of Annex A.~~

5. DELIVERY OF INTERCONNECT CAPACITY

5.1 SingTel will pay such damages to the Requesting Licensee for late delivery of Interconnect Capacity on the Local Leased Circuits to be supplied by SingTel to the Requesting Licensee in accordance with the SingTel standard Local Leased Circuits agreement. The Requesting Licensee acknowledges that the damages payable under

this clause 5.2 are a genuine estimate of the Requesting Licensee's direct loss in connection with the late delivery of the Interconnect Capacity on the Local Leased Circuits and the payment of such damages shall be SingTel's sole liability to the Requesting Licensee in respect of the late delivery of the Interconnect Capacity on the Local Leased Circuits.

CLAUSE 6 (FORMERLY CLAUSE 5) – MODIFICATION REQUIRED

5.6. DECOMMISSIONING

CLAUSE 6.1 (FORMERLY CLAUSE 5.1) – MODIFICATION REQUIRED

5.16.1 Subject to clauses ~~5~~6.2 and ~~5~~6.3, a Party (Decommissioning Party) may, for whatever reason: upon giving no less than six (6) months prior written notice to the other Party, close, replace or relocate any SGS in respect of which an Interconnection Link is connected, decommission an Interconnection Link or close a POI (**Decommissioning**).

As it is in the public's interest to ensure the continual interconnection of networks, SingTel must modify Clause 5.1 to provide that, notwithstanding the expiry of any notice period, any:

- (a) *decommissioning of an Interconnect Link can only take place after a substitute Interconnection Link has been commissioned;*
- (b) *closure, replacement or relocation of the SGS can only take place after a substitute SGS has been identified or established; and*
- (c) *closure of a POI can only take place after a substitute POI has been identified or established.*

SingTel comments: The process in clause 6.3 adequately covers off the position with respect to Virtual Interconnection. Clarifying words have been inserted in that clause.

CLAUSE 6 (FORMERLY CLAUSE 5) – MODIFICATION REQUIRED

- 5.26.2** (a) Subject to paragraph (b), the Decommissioning Party shall be responsible for and bear all direct costs incurred by both Parties in carrying out the Decommissioning. Direct costs are limited to removal of equipment and cabling at the POI.
- (b) When the request for Decommissioning is at the direction of a Third Party pursuant to a legal obligation binding on the Decommissioning Party, each

Party shall bear its own costs associated with the Decommissioning together with the direct costs incurred by that Party in respect of the establishment of alternative arrangements necessary to support the provision of Call Origination, Call Transit and Call Termination Services provided at the time of the Decommissioning.

SingTel appears to have inadvertently failed to include Call Transit in Clause 5.2(b).

SingTel comments: Agreed.

CLAUSE 5.3 – CONDITIONAL APPROVAL

5.36.3 (a) If the Requesting Licensee is the Decommissioning Party, the Requesting Licensee must also comply with the terms and conditions under which Local Leased Circuits are supplied by SingTel (including the payment of any early termination payments).

(b) If SingTel is the Decommissioning Party, SingTel will offer to arrange for the connection of Local Leased Circuits to the alternative or relocated SGS; ~~Interconnection Link~~ or POI prior to the Decommissioning.

5.46.4 Upon the happening of an event which causes or is likely to cause significant damage to the Network of a Party or which endangers or is likely to endanger the health or safety of any person (**Emergency Event**), that Party may close or replace its SGS or a POI or Decommission an Interconnection Link without prior written notice to the other Party, provided that it notifies the other Party as soon as practicable that the Emergency Event exists and that emergency relocation work is being or will be performed. The costs incurred as a result of, or in connection with, a closure or replacement of an SGS or a POI or Decommissioning of an Interconnection Link under this sub-clause shall be borne as follows:

(a) where the occurrence of the Emergency Event was caused as a result of the negligence or wilful act or omission of the first-mentioned Party, its employees, agents or contractors, that Party shall bear the costs associated with the closure, replacement or Decommissioning incurred by both Parties; and

(b) where the occurrence of the Emergency Event was not caused as a result of the negligence or wilful act or omission of the first-mentioned Party, its employees, agents or contractors, each Party shall bear its own costs associated with the closure, replacement or Decommissioning.

SCHEDULE 1

ANNEXURES

ANNEX A

INTERFACE SPECIFICATIONS

ANNEX A – CONDITIONAL APPROVAL

ANNEX A - INTERFACE SPECIFICATIONS

SECTION 1 - CCS NO. 7 SIGNALLING SYSTEM (MTP & ISUP) INTERFACE SPECIFICATION

1 General

1.1 The CCS No.7 signalling system interface shall conform to the followings:

(A) MTP following ITU-T Rec. Q.701 - Q.707

(B) ISUP following ITU-T Rec. Q.761 to Q.764 and Q.766 to support basic bearer service and supplementary services for voice and non-voice applications.

1.2 The interface specifications contained in this section are based on the interworking with SingTel's IGS/SGS.

A MTP

A1 STRUCTURE

A1.1 The MTP shall conform to ITU-T Rec. Q.701-Q.707 and comprise three (3) functional levels. The structure of the MTP is given below.

A1.2 The MTP shall allow messages from all different users to be transferred on the same signalling data link.

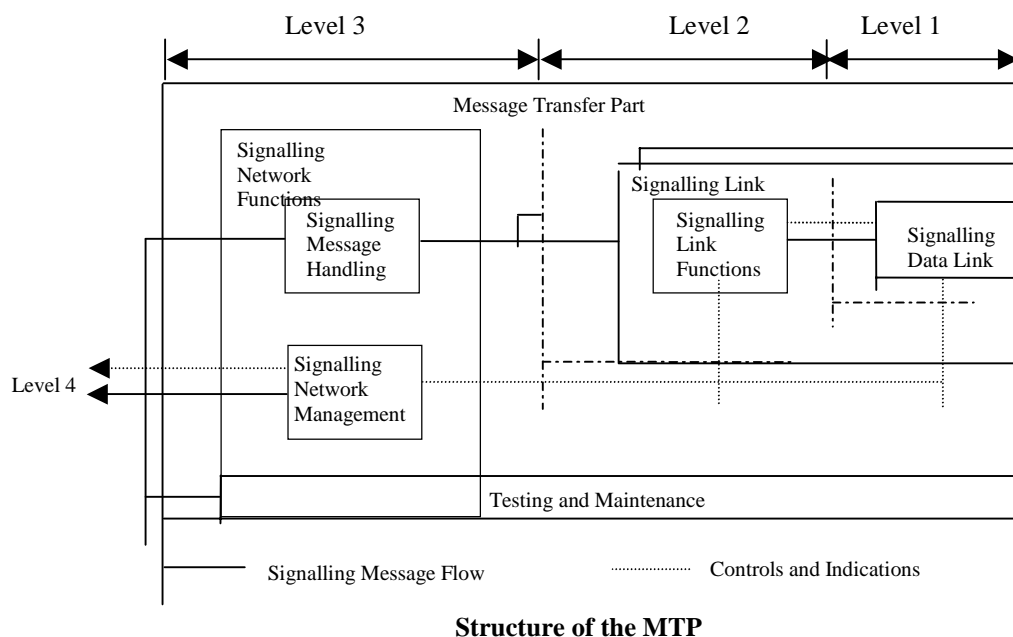

A2 SIGNALLING DATA LINK (MTP LEVEL 1)

A2.1 Requirements

The Signalling data link (MTP Level 1) shall conform to all requirements as specified in ITU-T Rec. Q.702.

A2.2 Digital Signalling Data Link

- (a) A signalling data link shall comprise two (2) data channels operating together in opposite direction at 64 kbit/s which are to be derived from TS 16 of the 2048 kbit/s PCM interface.
- (b) The data link shall be assignable by command to any speech channel (time-slot) available for 64 kbit/s user transmission if the standard time slots are not available.

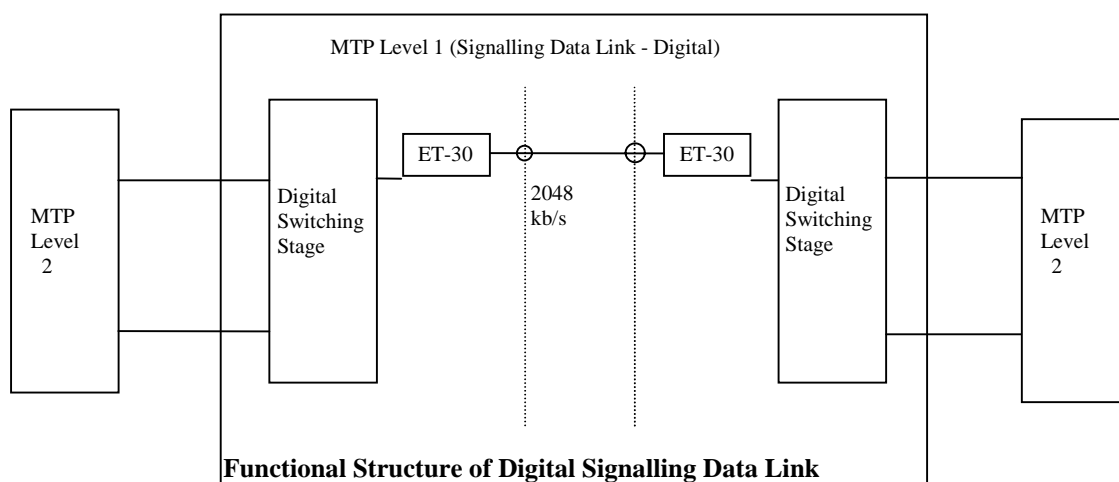

A3 SIGNALLING LINK (MTP LEVEL 2)

A3.1 Requirements

- (a) The Signalling Link (MTP Level 2) shall fulfil the requirements in all details as specified by ITU-T Rec. Q.703.
- (b) A single flag shall be sent between consecutive signal units. However, the exchange shall accept signal units which are delimited by either single flag or multiple flags.

- (c) The Signalling Link shall cater for messages with signalling information field of up to 272 octets. This shall allow a single message signal unit to accommodate information blocks of up to 268 octets in length accompanied by a routing label.
- (d) The spare bits in the link status signal unit shall be coded '0' and shall be ignored at the receiving side.
- (e) Basic error correction method shall be used in the exchange. For satellite connection, the preventive cyclic method shall be available.
- (f) Level 2 flow control shall be provided in the exchange. The exchange shall prevent excessive oscillation between congested and non-congested states when performing level 2 flow control.
- (g) The values of MTP level 2 timers (T1-T7) shall conform to the range/values as specified in ITU-T Rec. Q.703.

A4 SIGNALLING NETWORK FUNCTIONS (MTP LEVEL 3)

A4.1 Requirements

The MTP Level 3 shall include all signalling Network functions as specified in ITU-T Rec. Q.704.

A4.2 Signalling Message Handling

(a) Message Routing Function

- (i) The routing label shall be used for message routing purpose. It shall be possible to provide different routing plans for different user parts using the service indicator.
- (ii) The routing (eg outgoing Signalling Link sets) for a specific routing label shall be defined by command.
- (iii) The exchange acting as SP shall provide load-sharing between links belonging to the same link set for signalling traffic to be sent to a particular signalling point.

(b) Message Distribution

The exchange shall analyse the service indicator to determine which user part the message is to be delivered.

(c) Message Discrimination

The exchange shall analyse the destination code in the routing label to determine whether or not the exchange is the destination point of that message as specified in ITU-T Rec. Q.704.

A4.3 Signalling Network Management

(a) SP Congestion

The exchange shall conform to ITU-T Rec. Q.704 procedures to detect and handle SP congestion.

(b) Signalling Network Congestion

Based on the international standard of flow control, the congestion status shall be provided for the indication of Signalling Link or signalling route set congestion. Under normal operation, when the Signalling Link or route set is not congested, the congestion status is assigned the zero value. The setting of congestion onset, abatement and discard threshold(s) shall conform to ITU-T Rec. Q.704.

A4.4 **Signalling Traffic Management**

(a) Under normal situations, the signalling traffic to be sent to a particular signalling point shall be evenly distributed over all available Signalling Links within the link set.

(b) Changeover/Changeback

(i) It must be ensured that no messages are lost, duplicated or out-of-sequence during the changeover/changeback procedures. In the changeover procedure, the exchange shall divert traffic pertaining to that unavailable Signalling Link to the alternative Signalling Link with next priority in the same link set.

(ii) Time-controlled changeover shall be used when the exchange of a changeover message is not possible or not desirable.

(c) Management Inhibiting

(i) The exchange shall provide Signalling Link management inhibiting function for maintenance or testing purposes (eg if the link experiences too many changeovers/changebacks in a short time, or there is a significant link error rate). A Signalling Link marked 'inhibited' shall be unavailable to user part-generated signalling traffic. The management inhibit action shall not cause any link status

change at level 2. Inhibit request shall only be granted provided that the inhibit action does not cause any previously accessible destinations to become inaccessible at either end of the Signalling Link.

- (ii) Periodic tests shall be made on the inhibit status of inhibited links. Such periodic tests shall not overload the signalling Network and shall not perform at signalling point restart.
- (iii) Uninhibiting shall be initiated either by management function or by routing functions at either end of the Signalling Link.
- (d) Signalling Traffic Flow Control
 - (i) The exchange shall provide signalling traffic flow control function to limit signalling traffic at its source in the case when the signalling Network is not capable of transferring all traffic offered by the user because of Network failures or congestion situation. The flow control shall also initiate resumption of the normal traffic flow when the normal transfer capability is restored.
 - (ii) When a MTP user has become unavailable, the MTP shall not send a User Part Unavailable (UPU) message to the partner signalling points. Signalling messages received from the affected user parts of the partner signalling points shall be discarded as long as the local user parts are not available.

Upon receipt of an UPU message, the MTP shall discard these messages.

A4.5 Signalling Link Management

The exchange shall provide Signalling Link management functions as specified in ITU-T Rec. Q.704 to initiate and control actions aimed at restoring the normal availability of links and link sets.

A4.6 Signalling Route Management

The exchange shall provide signalling route management function as specified in ITU-T Rec. Q.704 to transfer information about changes in the availability of signalling routes in the Signalling Network so as to enable remote SPs to take appropriate signalling traffic management actions.

A4.7 Format and Codes of Signalling Network Management Messages

- (a) The label structure of Signalling Network Management messages coincides with the standard routing label as follows:

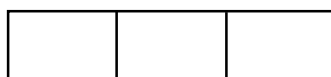

SLC	OPC	DPC	
4	14	14	First Bit Transmitted

The Signalling Link Code (SLC) indicates the Signalling Link, connecting the destination and originating points, to which the message is related. It is coded as 0000 for messages not related to a Signalling Link.

- (b) A list of heading code allocation of Signalling Network Management messages are given in Table A4-1 hereof.

A4.8 Time-out Values and Tolerances

The exchange shall provide MTP level 3 timers with values and tolerances as specified in ITU-T Rec. Q.704.

Message	H1	0000	0001	0010	0011	0100	0101	0110	0111	1000	1001	1010	1011	1100	1101	1110	1111
	H0																
	0000																
CHM	0001		COO	COA			CBD	CBA									
ECM	0010		ECO	ECA													
FCM	0011			TFC													
TFM	0100		TFP				TFA										
RSM	0101		RST														
MIM	0110		LIN	LUN	LIA	LUA	LID	LFU	LLT	LRT							
TRM	0111		TRA														
	1000																
	1001																
	1010																
	1011																
	1100																
	1101																
	1110																
	1111																

CHM = Changeover and Changeback Message FCM = Signalling-Traffic-flow-control Messages
 ECM = Emergency Changeover Message TFM = Transfer-prohibited-transfer-allow-transfer-restricted Messages
 RSM = Signalling-route-set-test Messages MIM = Management-inhibit Messages
 TRM = Traffic-restart-allowed Messages

Table A4-1: Heading Code Allocation of Signalling Network Management Messages

A5 MESSAGE TRANSFER PART SIGNALLING PERFORMANCE

- A5.1 The exchange MTP shall achieve a signalling performance as specified in ITU-T Rec. Q.706.
- A5.2 The exchange CCS No.7 signalling equipment shall be highly reliable such that not more than one in 10^7 messages will be lost due to failure in the MTP. Other performance factors (eg changeover performance times, etc.) shall also be conformed.

A6 TESTING AND MAINTENANCE

- A6.1 The exchange shall provide Signalling Network testing and maintenance requirements as specified in ITU-T Rec. Q.707.
- A6.2 An on-line Signalling Link test shall be applicable to Signalling Link to be activated or restored. The Signalling Link becomes available only if the test is successful. It shall be able to send Signalling Link test messages at regular intervals on an in-service Signalling Link using command.
- A6.3 The Signalling Network testing and maintenance messages shall be carried on the signalling channel in message signal units with service indication '0001'.
- A6.4 The exchange shall provide timers in ITU-T Rec. Q.707.

B ISUP SPECIFICATION

B1 ISUP Addressing

The ISUP address structure shall be capable of handling E.164 addresses in the Calling and Called number, and re-directing address information elements.

B2 Message Formats and Codes

- B2.1 Basic ISUP messages and signalling information as defined in ITU-T Rec. Q.762 with their formats and contents as specified in ITU-T Rec. Q.763 shall be provided. The encoding of the message types and parameter names are as shown in Table B2-1 and Table B2-2 respectively. Additional ISUP messages and parameters may be provided to support ISDN supplementary services defined in ITU-T Rec.73X-series.

Message Type			Coding
ACM	-	Address complete	00000110
ANM	-	Answer	00001001
BLO	-	Blocking	00010011
BLA	-	Blocking acknowledgment	00010101
CPG	-	Call progress	00101100
CGB	-	Circuit group blocking	00011000
CGBA	-	Circuit group blocking acknowledgment	00011010
CQM	-	Circuit group query	00101010
CQR	-	Circuit group query response	00101011
GRS	-	Circuit group reset	00010111
GRA	-	Circuit group reset acknowledgment	00101001
CGU	-	Circuit group unblocking	00011001
CGUA	-	Circuit group unblocking acknowledgment	00011011
CFN	-	Confusion	00101111
CON	-	Connect	00000111
COT	-	Continuity (receive only)	00000101
FAA	-	Facility accepted	00100000
FRJ	-	Facility reject	00100001
FAR	-	Facility request	00011111
FOT	-	Forward transfer	00001000
INF	-	Information	00000100
INR	-	Information request	00000011
IAM	-	Initial address	00000001
REL	-	Release	00001100
RLC	-	Release complete	00010000
RSC	-	Reset circuit	00010010
RES	-	Resume	00001110
SAM	-	Subsequent address	00000010
SUS	-	Suspend	00001101
UBL	-	Unblocking	00010100
UBA	-	Unblocking acknowledgment	00010110
USR	-	User-to-user information	00101101
SingTel internal use			11111111

Table B2-1 : Encoding of the Message Types

Parameter Name	Coding
Access delivery information	00101110
Access transport	00000011
Automatic congestion level	00100111
Backward Call indicators	00010001
Call diversion information	00110110
Called Party number	00000100
Calling Party number	00001010
Calling Party's category	00001001
Cause indicators	00010010
Circuit group supervision message type indicator	00010101
Circuit state indicator	00100110
Connected number	00100001
Continuity indicators (received only)	00010000
End of optional parameters	00000000
Event information	00100100
Forward Call indicators	00000111
Information indicators	00001111
Information request indicators	00001110
Nature of connection indicators	00000110
Optional backward Call indicators	00101001
Optional forward Call indicators	00001000
Original called number	00101000
Range and Status	00010110
Redirecting number	00001011
Redirection number	00001100
Redirection number restriction	01000000
Redirection information	00010011
Signalling Point Code	00011110
Subsequent number	00000101
Suspend/Resume indicators	00100010
Transmission medium requirement	00000010
User service information	00011101
User-to-user indicators	00101010
User-to-user information	00100000
SingTel internal use	11101111 11110011 11110100 11111001 11111010 11111011 11111101 11111100

Table B2-2 : ISUP Parameter Name Codes

B2.2 The exchange shall conform to the default interpretations of recognised parameters which contain codes currently indicated as being spare in ITU-T Rec. Q.763. This is to ensure that the exchange shall be able to interwork with a future version of ISUP. The procedures for handling of the unrecognised parameter values shall follow ITU-T Rec. Q.764 and the guidelines for handling of unrecognised information follow ITU-T Rec. Q.767.

B3 Network Features

B3.1 The exchange shall make an automatic repeated attempt:

- (a) on detection of dual seizure if it is the non-control exchange;
- (b) on receipt of BLO after sending an IAM and before any backward message has been received;
- (c) on receipt of a RSC after sending an IAM and before a backward message has been received; and
- (d) on receipt of an unreasonable message during Call setup.

B3.2 The exchange shall provide BLO (UBL) message and CGB (CGU) to permit the switching system or maintenance system to remove (return) traffic from (to) the distant terminal(s) of a circuit or group of circuits because of a fault or to permit testing.

B3.3 Circuit group query test procedure shall be provided in the exchange to audit the circuit state on a demand or routine basis. The range field of the CQM shall range from N=0 (single circuit) to maximum 31. If this value is exceeded the CQM message shall be discarded.

B4 Basic Signalling Procedures

B4.1 The exchange shall conform to all requirements as specified in ITU-T Rec. Q.764 whether acting as an originating exchange, a transit exchange or a destination exchange.

B4.2 Normal Call Release

The exchange shall provide release procedures based on a two (2) message (release, release complete) approach.

- (a) The Release Message (**REL**) initiates release of the circuit switched connection and it is required that the circuit is re-selectable from the subsequent exchange within the cross-office transfer time, TCU as specified in ITU-T Rec. Q.766.
- (b) Release Complete Message (**RLC**) shall be returned to the preceding exchange when the switched path is released and the circuit is re-selectable.

B4.3 Abnormal Condition

The exchange shall conform to ITU-T Rec. Q.764 on the handling of abnormal conditions which are listed below:

- (a) dual seizure;
- (b) transmission alarm handling for digital inter-exchange circuits;
- (c) reset of circuits and circuit groups;
- (d) failure in the blocking/unblocking sequence;
- (e) receipt of unreasonable signalling information message which includes:
 - (i) unexpected messages,
 - (ii) unrecognised signalling information messages,
 - (iii) unrecognised parameters,
 - (iv) unrecognised parameter values (both mandatory and optional),the exchange shall recognise all messages specified in Table B2-1;
- (f) failure to receive a RLC message;
- (g) failure to receive a response to an INR message; and
- (h) unable to release in response to a REL message.

B4.4 Automatic Congestion Control (**ACC**)

- (a) When the exchange reaches the overload condition, an automatic congestion level parameter shall be added to all REL message generated by the exchange. This parameter indicates the level of congestion to the adjacent exchanges which in turn, shall reduce their traffic to the overload affected exchange.

- (b) If the exchange returns to its normal traffic load, it shall stop including automatic congestion level parameters in REL messages. The adjacent exchanges shall then, after a predetermined time, automatically return to their normal status.

B5 Time Supervision

The exchange shall provide all timers specified in ITU-T Rec. Q.764.

B6 Performance of ISUP

The exchange shall achieve the ISUP signalling performance requirements as specified in ITU-T Rec. Q.766.

ISUP ATTACHMENT

1 ISUP CALL SET-UP SEQUENCE

The ISUP Call set-up sequence for the following traffic cases (all paths using CCS ISUP) are captured in this Attachment. The traffic cases shown here are not exhaustive.

The setting of parameters and indicators shown in this Attachment are tentative and subject to changes later.

<u>Item No.</u>	<u>Description</u>
1.1	Local Call - Successful Call Set-up Enbloc Operation; Terminating Access is ISDN
1.2	Enbloc Operation; Terminating Access is non-ISDN
1.3	Unsuccessful Call Set-up
1.4	Suspend and Resume Procedure

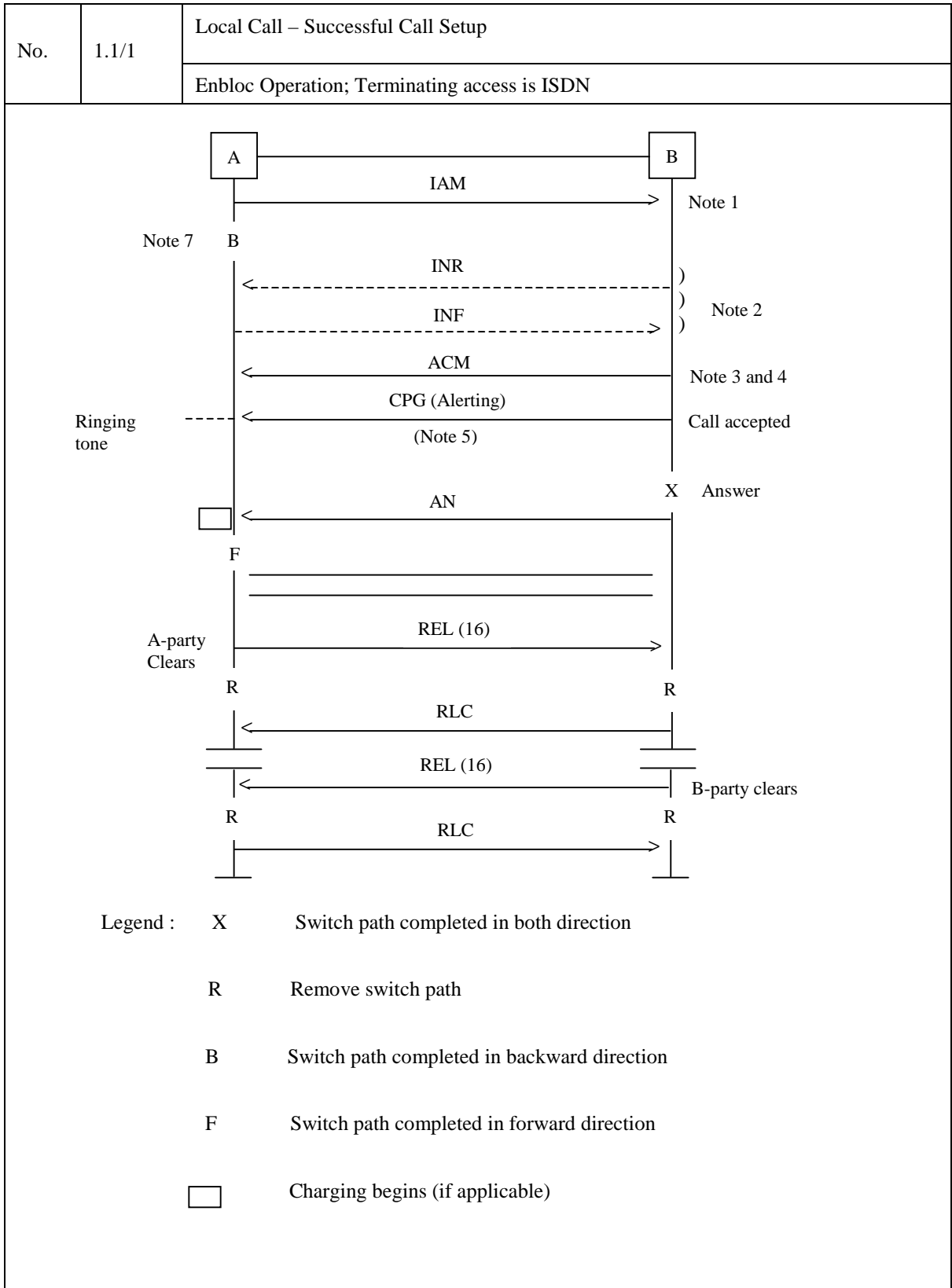

No.	1.1/2	Local Call – Successful Call Setup Enbloc Operation; Terminating access is ISDN																																										
<p>Note 1 :</p> <p>(a) CLI is always included in the IAM with an appropriate Presentation/Restriction/Not Available indication for the following traffic cases:-</p> <ul style="list-style-type: none"> - All originating Calls - Rerouted Calls - Transit Calls (Previous path is CCS-ISDNUP) <p>When the CLI is provided by the Network, the originating exchange sets the screening indicator to "Network provided". When the CLI is provided by the user or ISPBX, it is verified or screened for validity by the Network. If the user provided CLI is valid, the screening indicator is set to "user provided verified and passed". If the user provided CLI is not valid, the originating exchange defaults to the Network provided CLI.</p> <p>(b) The "ISDN User Part Preference Indicator" contained within the "Forward Call Indicator" of IAM is derived at the exchange from the bearer capability and supplementary service request contained in the Q.931 SETUP message.</p> <p>(c) The allocation of "Calling Party's Category" parameter field in the IAM is:-</p> <table border="0"> <tr><td>0 0 0 0 0 0 0 0</td><td>Calling Party's category unknown at this time</td></tr> <tr><td>0 0 0 0 0 0 0 1</td><td>Operator, language French</td></tr> <tr><td>0 0 0 0 0 0 1 0</td><td>Operator, language English</td></tr> <tr><td>0 0 0 0 0 0 1 1</td><td>Operator, language German</td></tr> <tr><td>0 0 0 0 0 1 0 0</td><td>Operator, language Russian</td></tr> <tr><td>0 0 0 0 0 1 0 1</td><td>Operator, language Spanish</td></tr> <tr><td>0 0 0 0 0 1 1 0</td><td>)</td></tr> <tr><td>0 0 0 0 0 1 1 1</td><td>) Reserved</td></tr> <tr><td>0 0 0 0 1 0 0 0</td><td>)</td></tr> <tr><td>0 0 0 0 1 0 0 1</td><td>SingTel internal use</td></tr> <tr><td>0 0 0 0 1 0 1 0</td><td>Ordinary Calling Party</td></tr> <tr><td>0 0 0 0 1 0 1 1</td><td>Calling Party with priority</td></tr> <tr><td>0 0 0 0 1 1 0 0</td><td>Data Call (Voice band data)</td></tr> <tr><td>0 0 0 0 1 1 0 1</td><td>Test Call</td></tr> <tr><td>0 0 0 0 1 1 1 0</td><td>Spare</td></tr> <tr><td>0 0 0 0 1 1 1 1</td><td>Payphone</td></tr> <tr><td>0 0 0 1 0 0 0 0</td><td>)</td></tr> <tr><td>to</td><td>) Spare</td></tr> <tr><td>1 1 0 1 1 1 1 1</td><td>)</td></tr> <tr><td>1 1 1 0 0 0 0 0</td><td>Operator without trunk offering facility</td></tr> <tr><td>1 1 1 0 0 0 0 1</td><td>Coinafon</td></tr> </table>			0 0 0 0 0 0 0 0	Calling Party's category unknown at this time	0 0 0 0 0 0 0 1	Operator, language French	0 0 0 0 0 0 1 0	Operator, language English	0 0 0 0 0 0 1 1	Operator, language German	0 0 0 0 0 1 0 0	Operator, language Russian	0 0 0 0 0 1 0 1	Operator, language Spanish	0 0 0 0 0 1 1 0)	0 0 0 0 0 1 1 1) Reserved	0 0 0 0 1 0 0 0)	0 0 0 0 1 0 0 1	SingTel internal use	0 0 0 0 1 0 1 0	Ordinary Calling Party	0 0 0 0 1 0 1 1	Calling Party with priority	0 0 0 0 1 1 0 0	Data Call (Voice band data)	0 0 0 0 1 1 0 1	Test Call	0 0 0 0 1 1 1 0	Spare	0 0 0 0 1 1 1 1	Payphone	0 0 0 1 0 0 0 0)	to) Spare	1 1 0 1 1 1 1 1)	1 1 1 0 0 0 0 0	Operator without trunk offering facility	1 1 1 0 0 0 0 1	Coinafon
0 0 0 0 0 0 0 0	Calling Party's category unknown at this time																																											
0 0 0 0 0 0 0 1	Operator, language French																																											
0 0 0 0 0 0 1 0	Operator, language English																																											
0 0 0 0 0 0 1 1	Operator, language German																																											
0 0 0 0 0 1 0 0	Operator, language Russian																																											
0 0 0 0 0 1 0 1	Operator, language Spanish																																											
0 0 0 0 0 1 1 0)																																											
0 0 0 0 0 1 1 1) Reserved																																											
0 0 0 0 1 0 0 0)																																											
0 0 0 0 1 0 0 1	SingTel internal use																																											
0 0 0 0 1 0 1 0	Ordinary Calling Party																																											
0 0 0 0 1 0 1 1	Calling Party with priority																																											
0 0 0 0 1 1 0 0	Data Call (Voice band data)																																											
0 0 0 0 1 1 0 1	Test Call																																											
0 0 0 0 1 1 1 0	Spare																																											
0 0 0 0 1 1 1 1	Payphone																																											
0 0 0 1 0 0 0 0)																																											
to) Spare																																											
1 1 0 1 1 1 1 1)																																											
1 1 1 0 0 0 0 0	Operator without trunk offering facility																																											
1 1 1 0 0 0 0 1	Coinafon																																											

No.	1.1/3	Local Call - Successful Call Setup
		Enbloc Operator; Terminating Access is ISDN
		<p> 1 1 1 0 0 0 1 0 SingTel internal use 1 1 1 0 0 0 1 1 SingTel internal use 1 1 1 0 0 1 0 0 SingTel internal use 1 1 1 0 0 1 0 1 PBX 1 1 1 0 0 1 1 0 PBX with priority 1 1 1 0 0 1 1 1) 1 1 1 0 1 0 0 0) 1 1 1 0 1 0 0 1) SingTel internal use 1 1 1 0 1 0 1 0) 1 1 1 0 1 0 1 1) 1 1 1 0 1 1 0 0) to) Spare for national use 1 1 1 1 1 1 1 0) 1 1 1 1 1 1 1 1 Spare </p>
Note 2:		INR/INF invoked (by end-to-end signalling) for Calls to transfer Information not included in the IAM
Note 3:		<p>When no status indication has been received from the ISDN access prior to the destination exchange determining that the complete Called Party number has been received, the indicators in the ACM will be set as follows:-</p> <p>- Called line status = 'NO INDICATION' - ISDN access indicator = 'ISDN'</p> <p>Subsequently, the indication that the destination user is being alerted is transferred in a CPG message which contains an Event indicator set to 'Alerting'.</p>
Note 4:		When connections are set-up to terminals having an automatic answer feature, the alerting indication may not be received from the Called Party. If a destination exchange receives an answer indication a ANM message is sent provided that an ACM has been sent; otherwise the CON message is sent (This CON then signifies both address complete and answer conditions). Indicators in CON will indicate 'SUBSCRIBER FREE' and 'ISDN' access. The destination exchange will through connect before CON is sent.

No.	1.1/4	Local Call - Successful Call Setup
		Enbloc Operation; Terminating access is ISDN
<p>Note 5 : For telephone Calls within the ISDN, ringing tone will be applied by the terminating exchange as soon as it is known that the subscriber is free.</p> <p>Note 6 : The Answer message received from the destination exchange shall carry a charging indication.</p> <p>Note 7 : <u>Completion of Transmission Path</u></p> <p>(a) At the originating exchange, on speech or 3.1 kHz audio Calls, through-connection of the transmission path will be completed in both directions immediately after the IAM has been sent. For other connection types, through-connect of the transmission path will be completed in the back-ward direction (The transmission path is completed in the forward direction on receipt of a CON or ANM message) immediately after the sending of IAM.</p> <p>(b) At the intermediate exchange (No interworking encountered), through-connection of the transmission path in both directions will be completed after IAM has been sent.</p>		

No.	1.2	Local Call - Successful Call Setup
		Enblock Operation; Terminating access is non-ISDN

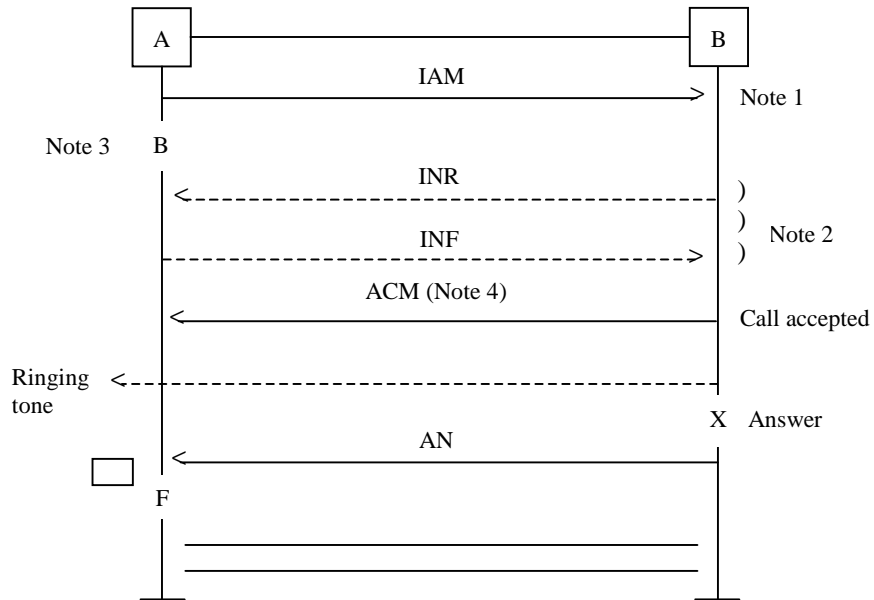

Note 1) See Case 1 of item 1.1

Note 2)

Note 3 : See Note 7 of Case 1, item 1.1

Note 4 : (a) An ACM shall be sent as soon as the destination exchange has determined that the complete Called Party number has been received, and the destination exchange established that the subscriber is free.

Indicators in the ACM will be set to indicate:-

- Called line status = 'SUBSCRIBER FREE'
- ISDN access indicator = 'NON ISDN'

(b) In the case of a PBX, an ACM shall be sent as soon as it has determined that the complete Called Party number has been received.

Indicators in ACM will be set to indicate:-

- Called line status = 'NO INDICATION'
- ISDN access indicator = 'NON ISDN'

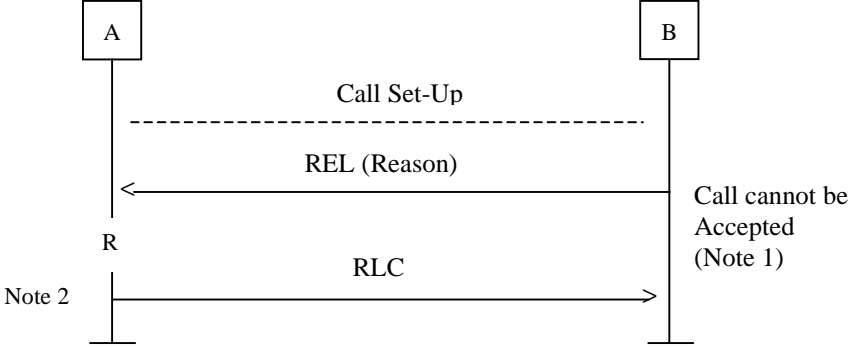
No.	1.3/1	Unsuccessful Call Setup																		
 <pre> sequenceDiagram participant A participant B A->>B: Call Set-Up B-->A: REL (Reason) A->>B: RLC Note over A: R Note over B: Call cannot be Accepted (Note 1) Note over A: Note 2 </pre>																				
Note 1:	If at any time in the Call setup the connection cannot be completed a release message which contains the reason is returned. The initiating exchange shall release the switched path (if established).																			
Note 2:	<p>On receipt of REL, the originating exchange releases the Switch path. In addition, it (if applicable)</p> <ul style="list-style-type: none"> (a) returns an indication (in-band or out-band) to the Calling Party; (b) attempts to re-route the Call setup. <p>When the A-exchange is ready for circuit re-selection, a RLC is sent to the succeeding exchange.</p>																			
Note 3:	<p>Some Unsuccessful Calls are listed below:-</p> <table border="1" data-bbox="405 1272 1214 1704"> <thead> <tr> <th data-bbox="405 1272 448 1301"></th> <th data-bbox="539 1272 711 1301"><u>Call Conditions</u></th> <th data-bbox="1070 1272 1214 1301"><u>Cause Value</u></th> </tr> </thead> <tbody> <tr> <td data-bbox="405 1335 443 1364">(a)</td> <td data-bbox="496 1335 892 1395">Unallotted (unassigned); Temporary disconnect; Terminating denied</td> <td data-bbox="1142 1335 1158 1364">1</td> </tr> <tr> <td data-bbox="405 1429 443 1458">(b)</td> <td data-bbox="496 1429 898 1489">Subscriber line busy, no Call waiting service or engaged in CW service</td> <td data-bbox="1142 1429 1169 1458">17</td> </tr> <tr> <td data-bbox="405 1523 443 1552">(c)</td> <td data-bbox="496 1523 683 1552">Ringing no reply</td> <td data-bbox="1142 1523 1169 1552">19</td> </tr> <tr> <td data-bbox="405 1585 443 1615">(d)</td> <td data-bbox="496 1585 951 1646">Calls rejected or not accepted due to SCR, SCA or incoming access bar service</td> <td data-bbox="1142 1585 1169 1615">21</td> </tr> <tr> <td data-bbox="405 1680 443 1709">(e)</td> <td data-bbox="496 1680 715 1709">Address incomplete</td> <td data-bbox="1142 1680 1169 1709">28</td> </tr> </tbody> </table>			<u>Call Conditions</u>	<u>Cause Value</u>	(a)	Unallotted (unassigned); Temporary disconnect; Terminating denied	1	(b)	Subscriber line busy, no Call waiting service or engaged in CW service	17	(c)	Ringing no reply	19	(d)	Calls rejected or not accepted due to SCR, SCA or incoming access bar service	21	(e)	Address incomplete	28
	<u>Call Conditions</u>	<u>Cause Value</u>																		
(a)	Unallotted (unassigned); Temporary disconnect; Terminating denied	1																		
(b)	Subscriber line busy, no Call waiting service or engaged in CW service	17																		
(c)	Ringing no reply	19																		
(d)	Calls rejected or not accepted due to SCR, SCA or incoming access bar service	21																		
(e)	Address incomplete	28																		

No.	1.3/2	Unsuccessful Call Setup
<p style="text-align: center;"><u>Call Conditions</u> <u>Cause Value</u></p>		
(f)	Subscriber line blocked for maintenance and operational reasons	27
(g)	All outgoing routes/trunks busy (at tandem exchange or PBX-DID routes)	34
(h)	Switching equipment congestion	42
Note 4 :	The exchange also recognizes all the cause values based on ITU-T Rec. Q.763. For other Unsuccessful Calls like double or multiple Call diversion not allowed, time-out which lead to Call failure, etc., it is possible to define other 'cause values' under national standard (coding standard of cause indicators = '10').	

No.	1.4	Suspend and Resume Procedure
<div style="text-align: center;"> <pre> sequenceDiagram participant A participant B A->>B: Conversation/Data Phase A->>B: SUS Note over A: A-party activates suspend Note over B: Suspend indication B->>A: RES Note over B: Resume indication Note over A: A-party request for reconnection or time-out (Note 4) A->>B: REL Note over A: R B->>A: RLC </pre> </div> <p>Note 1 : The suspend message indicates a temporary cessation of communication without releasing the Call.</p> <p>Note 2 : The above procedure applies to suspend initiated by the Called Party, except that the functions at the originating and destination exchanges are transposed.</p> <p>Note 3 : A suspend message can also be generated by the Network in response to clear-back from a interworking node or an on-hook condition from a telephone Called Party. On the other hand, RES may be initiated by Network in response to a reanswer signal from an interworking point or an off-hook condition from an analogue Called Party.</p> <p>Note 4 : If a request for reconnection or a resume message is not received within timer (T2) or timer (T6), then the controlling exchange will initiate the release procedure.</p>		

ANNEX A

SECTION 1A

Interconnect Testing

GENERAL MODIFICATION

SingTel must modify this Annex A to reflect the fact that both Licensees may be required to conduct testing to ensure that their networks can interconnect.

SingTel comments: Not Agreed. This process is to test the new Licensees' new switches. SingTel is using an existing live switch already interconnected with various other operators.

CLAUSE 1- MODIFICATION REQUIRED

1. TESTING PRINCIPLES

- 1.1 The purpose of the Interconnect Testing is to provide reassurance that the Requesting Licensee's Network can inter-work correctly with the SingTel Network and that the Interconnection will not adversely affect the existing services provided by SingTel to SingTel Customers.
- 1.2 Interconnection to SingTel's Network shall be carried out and provision of services under this RIO Agreement provided only after the satisfactory completion of the Interconnect Testing under this Annex and after SingTel is satisfied with the Interconnect Testing results in accordance with this Schedule.

SingTel must modify Clause 1 to impose a mutual obligation on the two Licensees to conduct necessary Interconnect Testing.

SingTel comments: This comment is misplaced. Clause 3.1 contains the relevant provisions where both parties have a testing role but the testing is in relation to the Requesting Licensee's switches.

CLAUSE 2- CONDITIONAL APPROVAL

2. PRE-REQUISITES FOR INTERCONNECT TESTING

- 2.1 Prior to the conduct of Interconnect Testing, the Requesting Licensee shall fully test its Network to ensure that it conforms to the Interface Specification as specified in Section 1 of Annex A. Any defects in hardware or software of the Requesting

Licensee's Network so discovered must be corrected before the commencement of Interconnect Testing.

CLAUSE 3 – CONDITIONAL APPROVAL

3. TESTING ITEMS

3.1 Interconnect Testing shall be carried out in accordance with SingTel's testing manuals. The Requesting Licensee shall perform Interconnect Testing in accordance with this Annex or as otherwise agreed by the SingTel, where:

- (i) initial Interconnection, whether Physical Interconnection or Virtual Interconnection, is to occur;
- (ii) a new POI is to be established; or
- (iii) the Parties have agreed to implement a Network Change.

CLAUSE 4 – MODIFICATION REQUIRED

4. TIMELINE FOR TESTING

4.1 The Requesting Licensee shall book the required test date and the testing duration at least one (1) month prior to the requested testing date. The Requesting Licensee shall submit the application form as contained in the Attachment to SingTel to request for Interconnect Testing. The request shall contain the necessary details for the testing setup as well as the proposed test schedule.

4.2 SingTel shall respond in writing within ten (10) Business Days upon receipt of the written request on whether SingTel is able to accommodate the testing on the proposed test dates. Should SingTel not be able to perform the testing on the requested test dates, SingTel shall counter-propose an alternative test schedule with the response and negotiate in good faith with the Requesting Licensee to arrange an alternative schedule.

The alternative test schedule that SingTel proposes must not result in any unreasonable delay in carrying out the Interconnect Testing. SingTel must modify Clause 4.2 to specify the latest date by which it must commence testing.

SingTel comments: The schedule of test is allocated on a first-come-first serve basis. Where requested, the earliest timeslot available shall be allocated for the tests, and this is done on a non-discriminatory basis.

- 4.3 The Parties shall act in good faith and make reasonable endeavours to complete all test items within the estimated testing period.
- 4.4 The requested testing duration is subject to mutual agreement by the Parties.
- 4.5 Any request for extension to the testing duration beyond the agreed time frame by the Requesting Licensee is subject to mutual agreement by both Parties. The Requesting Licensee shall make its request for extension at least two (2) Business Days prior to the end of the testing duration.
- 4.6 SingTel shall not be liable to the Requesting Licensee for any delay in completing all the test items.

Clause 4.6 is not reasonable. SingTel must revise this clause to provide that it is not responsible for delays in completing test items if it did not cause such delays or if such delays were outside its reasonable control.

SingTel comments: Not agreed. SingTel cannot be liable for any delay, as both parties are required to act in good faith and make reasonable endeavours to complete all test items as indicated in relation to clause 4.3.

CLAUSE 5 – CONDITIONAL APPROVAL

5. DAILY TIME TABLE FOR INTERCONNECT TESTING

- 5.1 All interconnect testing shall be carried out during Business Days between 0900 hours and 1700 hours, with one (1) hour lunch break in between.

CLAUSE 6 – MODIFICATION REQUIRED

6. TESTING RESULTS

- 6.1 Connection of the Requesting Licensee's Network to SingTel's designated IGS/SGS shall be carried out only upon satisfactory completion of the Interconnect Testing in accordance with SingTel's interconnect manuals and after SingTel is satisfied with the Interconnect Testing results.
- 6.2 In the event that SingTel identifies a critical problem(s), the Requesting Licensee shall ensure that such problems be resolved within the testing period. Otherwise, the Requesting Licensee shall make booking for a new testing date to verify these critical problem(s) when solutions are available.

SingTel may only decline to physically link networks where doing so would result in physical or technical harm.

SingTel comments: Not agreed. It is not possible to demonstrate physical or technical harm until such harm has occurred. The purpose of testing is to ensure proper inter-working of the networks not harm.

CLAUSE 7 - CONDITIONAL APPROVAL

7. CHARGES FOR INTERCONNECT TESTING

- 7.1** In the provision of SingTel's facilities and engineering support for the Interconnect Testing and the eventual connection to SingTel Network, the Requesting Licensee shall pay SingTel, the Charges based on the testing duration inclusive of any such extension period, as set out in Schedule 9.
- 7.2** All Calls made during the Interconnect Testing shall be chargeable to the Requesting Licensee.

CLAUSE 8 – MODIFICATION REQUIRED

8. CANCELLATION AND DELAY IN TESTING

- 8.1** The Requesting Licensee shall adhere to the testing date and testing duration as approved by SingTel.
- 8.2** Any request for cancellation of Interconnect Testing shall be made in writing to SingTel and the Requesting Licensee shall pay SingTel the cancellation charges in accordance with Schedule 9.
- 8.3** In the event that Interconnect Testing is completed or is terminated by the Requesting Licensee before the last day of the testing duration, the Requesting Licensee shall pay SingTel the Charges for the unused duration from the next Business Day after the completion or termination of Interconnect Testing to the last day of the testing duration. In which event testing shall terminate on the day on which testing was completed or terminated and SingTel shall not be obliged and shall not be required to effect any further testing for the remaining testing duration.

Requiring a Licensee to pay for services that are not provided is unreasonable. SingTel must revise this Clause 8.3 to provide that charges will be assessed only for Interconnect Testing that has actually been performed.

SingTel comments: As resources have been committed for the testing period, the Party causing the delay, late cancellation or requesting extension for the testing period should bear the cost of resources for the interconnect testing incurred by the other Party. One party should not be penalised for the delay caused by the other party. The resources that had been committed for the testing could also have been used for one party's own testing, to test new services and features prior to their launch. Delays or any extension of the already committed testing could substantially delay the roll-out plans for any revenue generating services and features. It is appropriate to require the party causing the delay to at least compensate the other party for the resources tied down by the testing and not utilised. This is also important for other Requesting Licensee's who are penalised by waiting for testing time that has not been properly used by another Requesting Licensee.

8.4 SingTel may unilaterally ~~declare~~ delay or postpone the testing date or duration due to ~~its service exigency~~ matters outside SingTel's reasonable control. SingTel shall allocate a corresponding extension of the testing period for the number of days so delayed or allocate a new testing date for Interconnect Testing on a non-discriminatory basis. The Requesting Licensee shall not be liable to pay additional Charges for such extension period granted.

SingTel may not postpone Interconnect Testing in order to delay a Requesting Licensee's ability to provide service. Nor may it discriminate in favour of its own operations, or those of any affiliate, in the provision of Interconnect Testing services. SingTel must revise this Clause 8.4 to define what events will constitute "service exigencies". SingTel should also clarify that it will allocate Interconnect Testing resources in a non-discriminatory manner.

SingTel comments: Redrafted to cover service exigency point. Also agree to non-discriminatory basis.

APPLICATION FORM FOR INTERCONNECT TESTING

OPERATOR	
Name of Operator	License Type/Class
Business Address	
Postal Code	
I wish to apply for SS7 Interworking Test	
For the period from _____ to _____ . (____ Days)	
Testing Fees — \$1,200 per day	
In support of my application, I provide the following Technical Information for the Setting up of Interconnect Testing	
For SS7 Testing	
4 Digit Access Code:	
Signalling Point Code:	
Signalling Mode:	
Signalling Timeslot:	
Signalling Link Code:	
Circuit Direction:	
Circuit Selection Order:	

I confirm that we have a valid License from the Authority to operate telecommunication services. I agree that approval of this application is subject to SingTel's discretion and that SingTel reserves the right to decline the application or to make variation to the requested testing period without giving any reason.

I understand and agree that I shall execute the RIO Agreement prior to the conduct of the Interconnect Testing. I am liable for all charges that may arise from any delay or cancellation of Interconnect Testing should the RIO Agreement not be executed prior to the test.

I understand and agree that in addition to the charges for Interconnect Testing, all Calls made during the Interconnect Testing shall be chargeable to me.

I understand and agree that any request for cancellation of Interconnect Testing shall be made in writing to SingTel and I shall pay SingTel the cancellation charges as follows:

No. of calendar days (from the receipt of cancellation notice to the date of commencement of testing):	
<7	100%
7-13	80%
14-20	35%
>21	20%

I acknowledge that the interconnect testing may only be carried out subject to the Terms and Conditions of the RIO Agreement, and the Terms and Conditions of this Application. I agree to be bound by the said terms and conditions and in consideration of my application being approved. Upon approval, I agree to pay the charges as required.

I confirm that all the information given in making this application is true, correct and complete.

Signature	Designation
Name	Date

FOR SINGTEL USE	
The application is	<input type="checkbox"/> Approved <input type="checkbox"/> Rejected Reason for rejection: _____
Agreed Schedule for Interconnect Testing	
from _____ to _____ . (____ Days)	
SingTel SS7 Signalling information	
Signalling Point Code	
Signalling Mode	
Signalling Timeslot	
Signalling Link Code	
Circuit Direction	
Circuit Selection Order	
Signature	Designation
Name	Date

ANNEX A

SECTION 2

ANNEX A – CONDITIONAL APPROVAL

ANNEX A - INTERFACE SPECIFICATION

SECTION 2 - SS7 INTERWORKING TESTING MANUAL

1 INTRODUCTION

1.1 GENERAL

1.1.1 This manual describes the test items for the SS7 testing, the testing principles and the criteria for successful testing.

1.1.2 The ITU-T Rec Q.78X referred to in this manual are the 1992 version.

2 TESTING ACTIVITIES

2.1 SS7 COMPATIBILITY TEST

2.1.1 The ITU-T Rec. Q.781 to Rec. Q.785 shall be used as guidelines for the following SS7 compatibility tests:-

- (a) MTP Level 2;
- (b) MTP Level 3;
- (c) ISUP Basic Call Control; and
- (d) ISUP Supplementary Services.

2.1.2 The above SS7 compatibility tests are described below and shall be performed in a test environment. The details can be found in [Annex A to D].

2.2 TEST CONFIGURATION

Signalling links are required to be connected as shown below. An SS7 Protocol Analyser shall be terminated across the two links to monitor and trap the SS7 messages exchanged between the two signalling points.

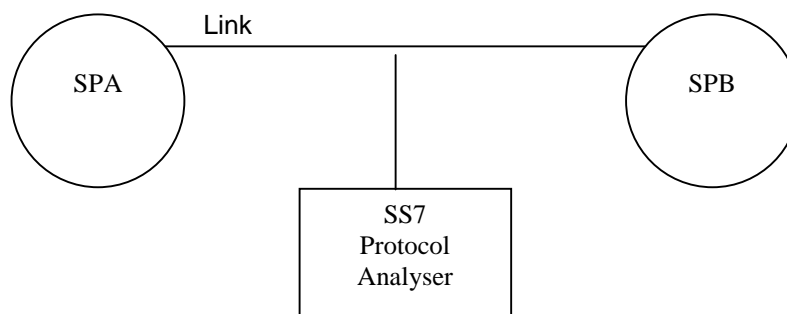

2.3 SS7 MTP LEVEL 2

2.3.1 The MTP level 2 test items are selected from the ITU-T Rec. Q.781 to confirm the protocol specified in Rec. Q.703.

2.3.2 The test items to verify normal/emergency alignment and activation/deactivation procedures are identified. Details of the tests can be found in [Annex A].

2.4 SS7 MTP LEVEL 3

2.4.1 The MTP level 3 test items are selected from the ITU-T Rec. Q.782 to confirm the protocol specified in Rec. Q.704 and Rec. Q.707.

2.4.2 The test items to verify Signalling Link management, signalling message handling, changeover, changeback and Signalling Link test are identified. Details of the tests can be found in [Annex B].

2.5 SS7 ISUP BASIC CALL CONTROL

2.5.1 The ISUP Basic Call Control Test are selected from ITU-T Rec. Q.784 to confirm the protocol specified in the ITU-T Rec. Q.761 to Rec. Q.764.

2.3.1 The test items to verify circuit supervision, normal Call setup, normal release, unsuccessful Call setup, and abnormal situations during a Call, special Call setup and various bearer services are identified. Details of the tests can be found in [Annex C].

2.6 SS7 ISUP SUPPLEMENTARY SERVICES

2.6.1 The ISUP protocol test for supplementary services are selected from the ITU-T Rec. Q.785 to confirm the implementation of supplementary services in the ITU-T Rec. Q.730 and Rec. Q.767.

2.6.2 The test items to verify CLI supplementary services are identified. Details of the tests can be found in [Annex D].

2.7 JUNCTION OR CIRCUIT TEST

2.7.1 The junction or circuit test shall confirm the speech connection between the IGS/SGS and the Requesting Licensee's Network through actual Call through test.

ANNEX A
SECTION 2A

ANNEX A - INTERFACE SPECIFICATION

SECTION 2A - SS7 MTP LEVEL 2 TEST SPECIFICATION - Q.781 RECOMMENDATION

1 Link State Control - expected signal units/orders

1.2 Timer T2

To check "Not Aligned" Timer T2. Timer T2 shall be in the range of 5 secs to 150 secs.

1.5 Normal alignment - correct procedure (FISU)

To check normal alignment procedure. Confirm that the link aligns and enters "In-service" state. Confirm that the timer T4 normal proving period is in the range of 7.5 secs to 9.5 secs (nominally at 8.2 secs).

1.21 Both ends set emergency

To check the emergency alignment procedure and timer T4 (Pe). Confirm that correct emergency alignment procedure is performed. T4 (Pe) shall be between 400 to 600 ms.

1.29 Deactivation during link in service

To check the deactivation of a Signalling Link from the "In Service" state. Confirm that an "In service" link can be put to "Out of Service" state by command.

3 Transmission failure

3.5 Link in service (Break Tx path)

To test the response to a transmission failure when link is "In service". Confirm that SIOS is returned by A when the Tx link fails.

SECTION 2A : SS7 MTP LEVEL 2 TEST SPECIFICATION – Q.781 RECOMMENDATION

TEST ITEM	Q.781 TEST ITEM	TITLE	RESULT	DATE	TESTED BY	REMARK
1	1.2	Timer T2				
2	1.5	Normal alignment - correct procedure (FISU)				
3	1.21	Both ends set emergency				
4	1.29	Deactivation during link in service				
5	3.5	Link in service (Break Tx path)				

ANNEX A

SECTION 2B

ANNEX A - INTERFACE SPECIFICATION

SECTION 2B - SS7 MTP LEVEL 3 TEST SPECIFICATION - Q.782 RECOMMENDATION

1 Signalling Link Management

1.1 First Signalling Link activation

To put into service a Signalling Linkset with 1 Signalling Link. Confirm that the Signalling Link becomes available after alignment.

1.2 Signalling linkset deactivation (where applicable)

To remove from service a Signalling Linkset with 2 Signalling Link. Confirm that the Signalling Linkset becomes unavailable.

2 Signalling message handling

2.4 Load sharing within a linkset (where applicable)

2.4.1 All links available

To check the load sharing within a linkset with all the links available. Confirm that Calls with different values of SLS are shared among the various Signalling Links.

2.4.2 With one link unavailable

To check the load sharing within a linkset when one link is unavailable. Confirm that Calls with different values of SLS are shared among the remaining available Signalling Links.

3 Changeover

3.20 Changeover as a compatibility test (where applicable)

To check the changeover procedure as compatibility test. Confirm that changeover procedure is performed over the other available Signalling Link. The procedure may be activated from one side or from both sides depending on the switch.

4 Changeback

4.1 Changeback within a linkset (where applicable)

To check that the changeback procedure is correctly performed on restoration of a link in a linkset. Confirm that the changeback procedure is correctly performed and that the link can carry traffic.

12 Signalling link test

12.1 After activation of a link

To check the Signalling Link test procedure after activation of a Signalling Link. Confirm that SLTM and SLTA messages are exchanged between the two signalling points. Confirm that the link becomes available and can carry traffic.

SECTION 2B : SS7 MTP LEVEL 3 TEST SPECIFICATION – Q.782 RECOMMENDATION

TEST ITEM	Q.782 TEST ITEM	TITLE	RESULT	DATE	TESTED BY	REMARK
1	1.1	First Signalling Link activation				
2	1.2	Signalling linkset deactivation				
3	2.4.1	Load sharing within linkset - All links available				
4	2.4.2	Load sharing within linkset - With one link unavailable				
5	3.20	Changeover as a compatibility test				
6	4.1	Changeback within a linkset				
7	12.1	Signalling link test after activation of a link				

ANNEX A

SECTION 2C

ANNEX A - INTERFACE SPECIFICATION

SECTION 2C - SS7 ISUP BASIC CALL CONTROL TEST SPECIFICATION - Q.784

RECOMMENDATION

1. Circuit supervision

1.2 Reset of circuits

1.2.1 RSC received on an idle circuit

To verify that on receipt of a reset circuit message SP A will respond by sending a release complete message.

1.2.2 RSC sent on an idle circuit

To verify that SP A is able to generate reset-circuit message.

1.2.5 Circuit group reset received

To verify that on receipt of one circuit group reset message SP A will respond by sending a circuit group reset acknowledge message.

1.2.6 Circuit group reset sent

To verify that SP A is able to generate a circuit group reset message.

1.3 Blocking of circuits

1.3.1 Circuit group blocking/unblocking

1.3.1.1 CGB and CGU received

To verify that the circuit group blocking feature can be correctly initiated.

1.3.1.2 CGB and CGU sent

To verify that SP A is able to generate one circuit group blocking message and one circuit group unblocking message.

1.3.2 Circuit blocking/unblocking

1.3.2.1 BLO received

To verify that the blocking/unblocking procedure can be correctly initiated.

1.3.2.2 BLO sent

To verify that SP A is able to generate blocking messages.

1.3.2.3 Blocking from both ends; removal of blocking from one end

To verify that the blocking/unblocking procedure can be correctly initiated.

1.3.2.4 IAM received on a remotely blocked circuit

To verify that an IAM will unblock a remotely blocked circuit.

2. Normal Call Setup

2.2 Called address sending

2.2.1 “en bloc” operation

To verify that a Call can be successfully established (all digits included in the IAM).

2.2.2 Overlap operation (with SAM)

To verify that signalling point A can initiate a Call using an IAM followed by a SAM.

2.3 Successful Call setup

2.3.1 Ordinary Call (with various indications in ACM)

To verify that a Call can be successfully completed using various indications in address complete messages.

2.3.2 Ordinary Call (with ACM, CPG and ANM)

To verify that a Call can be successfully completed using address complete message, Call progress message and answer message.

2.3.3 Ordinary Call (with various indications in CON)

To verify that a Call can be successfully completed using various indications in the connect message.

2.3.6 Blocking and unblocking during a Call (initiated)

To verify that the circuit blocking and unblocking procedure can be correctly initiated during a Call.

2.3.7 Blocking and unblocking during a Call (received)

To verify that the circuit blocking and unblocking procedure can be correctly received during a Call.

3. Normal Call release

3.1 Calling party clears before address complete

To verify that the Calling party can successfully release a Call prior to receipt of any backward message.

3.2 Calling party clears before answer

To verify that the Calling Party can successfully release a Call prior to receipt of answer.

3.3 Calling Party clears after answer

To verify that the Calling Party can successfully release a Call after answer.

3.4 Called Party clears after answer

To verify that a Call can be successfully released in the backward direction.

3.5 Suspend initiated by the Network

To verify that the Called subscriber can successfully clear and reanswer a Call.

3.6 Suspend and resume initiated by a Calling Party

To verify that the Calling subscriber can successfully suspend and resume a Call.

3.7 Suspend and resume initiated by a Called Party

To verify that the Called subscriber can successfully suspend and resume a Call.

4. Unsuccessful Call setup

4.1 Validate a set of known causes for release

To verify that the Call will be immediately released by the outgoing signalling point if a release message with a given cause is received and the correct indication is given to the Calling Party.

- 4.1.1 Called subscriber busy : # 17 user busy
- 4.1.2 Destination circuits are busy : # 42 switching equipment congestion
- 4.1.3 Call rejected or not accepted due to SCR,SCA or IAB service : #21 Call rejected
- 4.1.4 Calling to an unallocated number : #1 unallocated number
- 4.1.5 All outgoing routes/trunk busy : #34
- 4.1.6 Q.118 timer; no answer from Called Party : # 19 no answer from user
- 4.1.7 Address incomplete : #28

5. Abnormal situation during a Call

5.2 Timers

5.2.2 T9 : waiting for an answer message

To verify that if an answer message is not received within T9 after receiving an address complete message the connection is released by the outgoing signalling point.

5.2.4 T6 : waiting for RES (Network) message

To verify that the Call is released at the expiration of timer T6.

5.3 Reset of circuits during a Call

5.3.1 Of an outgoing circuit

To verify that on receipt of a reset message the Call is immediately released - outgoing Call.

5.3.2 Of an incoming circuit

To verify that on receipt of a reset message, a Call is immediately released - incoming Call.

7. Bearer services

7.1 64 kb/s unrestricted

7.1.1 Successful Call setup

To verify that a 64 kb/s Call can be successfully completed using appropriate transmission medium requirement and user service information parameters.

7.1.2 Unsuccessful Call setup

To verify that the Call will be immediately released by the outgoing signalling point if a release message with a given cause is received and, for circuits equipped with echo control, the echo control device is enabled.

7.2 3.1 kHz audio

7.2.1 Successful Call setup

To verify that a 3.1 kHz audio Call can be successfully completed using appropriate transmission medium requirement and information parameters.

7.3 Speech

7.3.1 Successful Call setup

To verify that a speech Call can be successfully completed using appropriate transmission medium requirement and information parameters.

SECTION 2C : SS7 ISUP BASIC CALL CONTROL TEST SPECIFICATION – Q.784 RECOMMENDATION

TEST ITEM	Q.784 TEST ITEM	TITLE	RESULT	DATE	TESTED BY	REMARK
1	1.2.1	RSC received on an idle circuit				
2	1.2.2	RSC sent on an idle circuit				
3	1.2.5	Circuit group reset received				
4	1.2.6	Circuit group reset sent				
5	1.3.1.1	CGB and CGU received				
6	1.3.1.2	CGB and CGU sent				
7	1.3.2.1	BLO received				
8	1.3.2.2	BLO sent				
9	1.3.2.3	Blocking from both ends; removal of blocking from one end				
10	1.3.2.4	IAM received on a remotely blocked circuit				
11	2.2.1	"EN BLOC" operation				
12	2.2.2	Overlap sending (with SAM)				
13	2.3.1	Ordinary Call (with various indications in ACM)				

TEST ITEM	Q.784 TEST ITEM	TITLE	RESULT	DATE	TESTED BY	REMARK
14	2.3.2	Ordinary Call (with ACM, CPG and ANM)				
15	2.3.3	Ordinary Call (with various indications in CON)				
16	2.3.6	Blocking and unblocking during a Call (initiated)				
17	2.3.7	Blocking and unblocking during a Call (received)				
18	3.1	Calling Party clears before address complete				
19	3.2	Calling Party clear before answer				
20	3.3	Calling Party clear after answer				
21	3.4	Called Party clear after answer				
22	3.5	Suspend initiated by the Network				
23	3.6	Suspend and resume initiated by a Calling Party				
24	3.7	Suspend and resume initiated by a Called Party				
25	4.1.1	Called subscriber busy: #17 user busy				
26	4.1.2	Destination circuits are busy: #42 switching equipment congestion				
27	4.1.3	Call rejected or not accepted due to SCR,SCA or IAB service : #21 Call rejected				
28	4.1.4	Calling to an unallocated number: #1 unallocated number				

TEST ITEM	Q.784 TEST ITEM	TITLE	RESULT	DATE	TESTED BY	REMARK
29	4.1.5	All outgoing routes/trunks busy : #34				
30	4.1.6	Address incomplete : #28				
31	4.1.7	Q.118 timer, no answer from Called Party: #19 no answer from user				
32	5.2.2	T9: waiting for an answer message				
33	5.2.4	T6: waiting for RES (Network) message				
34	5.3.1	Of an outgoing circuit				
35	5.3.2	Of an incoming circuit				
36	7.1.1	Successful Call setup (64kbit/s unrestricted)				
37	7.1.2	Unsuccessful Call setup (64kbit/s unrestricted)				
38	7.2.1	Successful Call setup (3.1kHz audio)				
39	7.3.1	Successful Call setup (Speech)				

ANNEX A

SECTION 2D

ANNEX A - INTERFACE SPECIFICATION

SECTION 2D - SS7 ISUP PROTOCOL TEST SPECIFICATION FOR SUPPLEMENTARY

SERVICES - Q.785 RECOMMENDATION

3 CLI

3.1.1 CLIP - Network provided : sent

To verify that CLIP (Network provided) can be correctly sent in the Calling Party number parameter.

3.1.2 CLIP - Network provided : received

To verify that CLIP (Network provided) can be correctly received in the Calling Party number parameter.

3.2.1 CLIP - user provided : sent

To verify that CLIP (user provided) can be correctly sent in the Calling Party number parameter.

3.2.2 CLIP - user provided : received

To verify that CLIP (user provided) can be correctly received in the Calling Party number parameter.

3.3.1 CLIR - Network provided : sent

To verify that CLIR (Network provided) can be correctly sent in the Calling Party number parameter.

3.3.2 CLIR - Network provided : received

To verify that CLIR (Network provided) can be correctly received in the Calling Party number parameter.

3.4.1 CLIR - user provided : sent

To verify that CLIR (user provided) can be correctly sent in the Calling Party number parameter.

3.4.2 CLIR - user provided : received

To verify that CLIR (user provided) can be correctly received in the Calling Party number parameter.

SECTION 2D : SS7 ISUP PROTOCOL TEST SPECIFICATION FOR SUPPLEMENTARY SERVICES - Q.785 RECOMMENDATION

TEST ITEM	Q.785 TEST ITEM	TITLE	RESULT	DATE	TESTED BY	REMARK
1	3.1.1	CLIP - Network provided: sent				
2	3.1.2	CLIP - Network provided: received				
3	3.2.1	CLIP - user provided: sent				
4	3.2.2	CLIP - user provided: received				
5	3.3.1	CLIR - Network provided: sent				
6	3.3.2	CLIR - Network provided: received				
7	3.4.1	CLIR - user provided: sent				
8	3.4.2	CLIR - user provided: received				

ANNEX A

SECTION 2E

Interconnect Links and Interconnect Configuration between SingTel and FBO

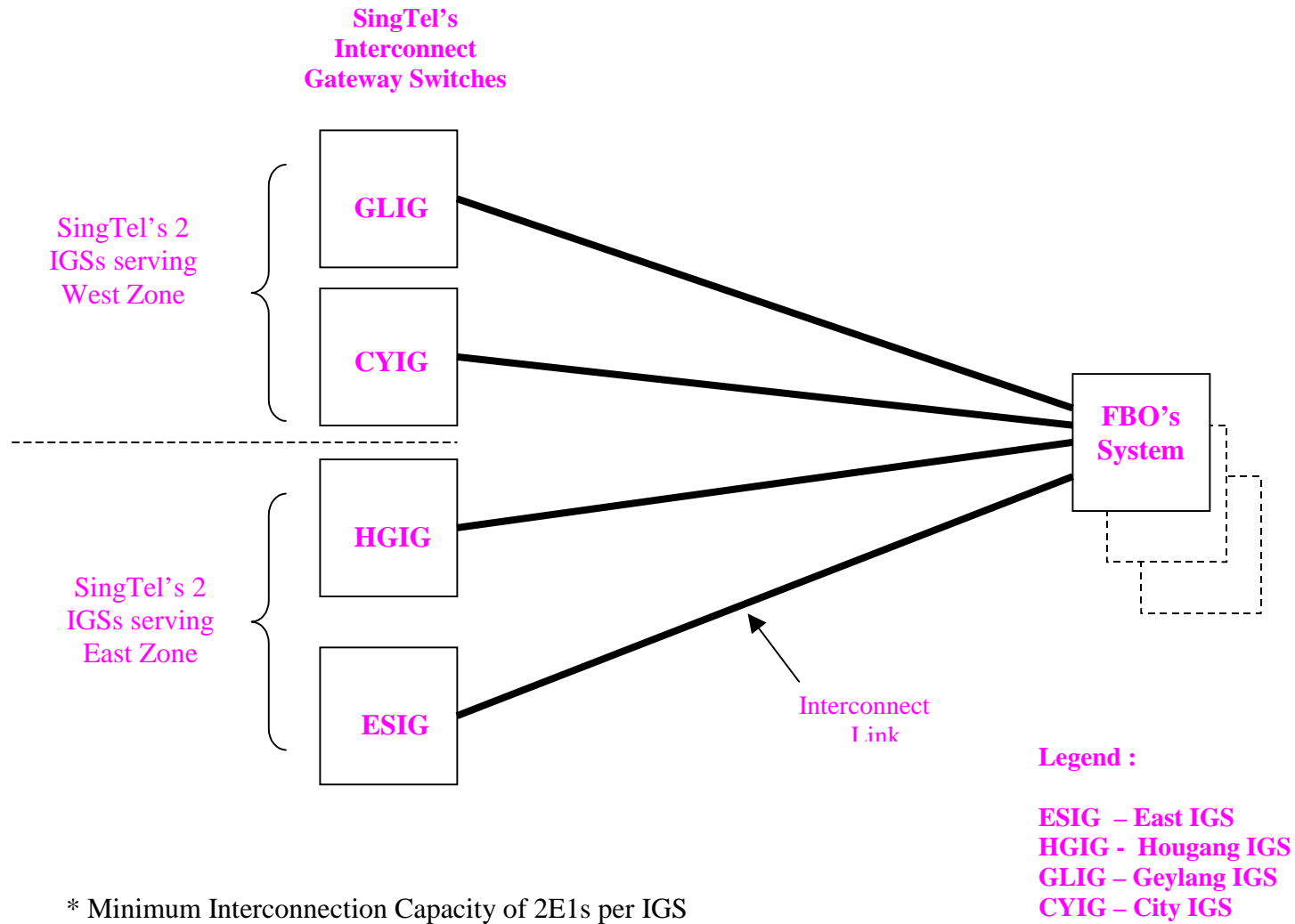

ANNEX A

SECTION 2F

Interconnect Links and Interconnect Configuration between SingTel and SBO

SingTel's
SBO Gateway Switch

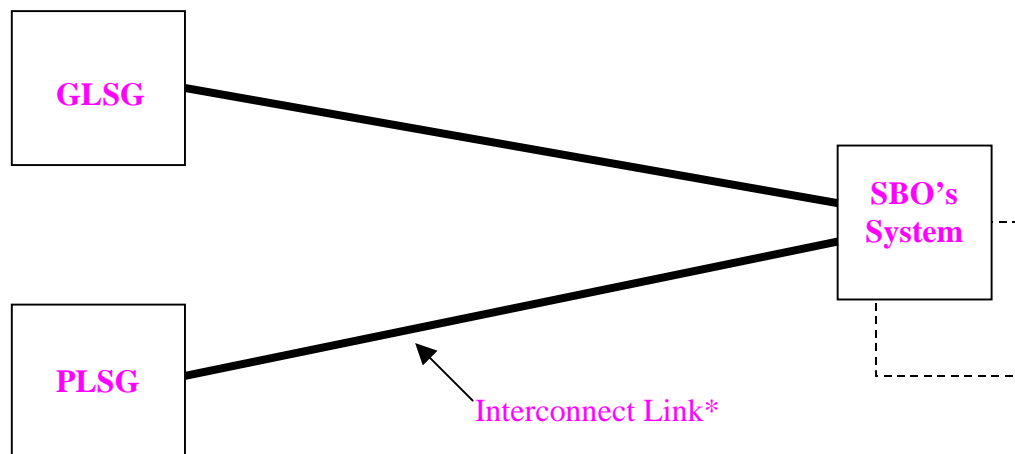

Legend :

GLSG – Geylang SGS

PLSG – Paya Lebar SGS

* Minimum Interconnection Capacity of 2 E1s per SGS

ANNEX B

OPERATIONAL PROCEDURES

ANNEX B – MODIFICATION REQUIRED

ANNEX B – OPERATIONAL PROCEDURES

CLAUSE 1 – MODIFICATION REQUIRED

1. INTRODUCTION

- 1.1 This Annex provides the operations and maintenance procedures to be carried out by the ~~Requesting Licensee~~Parties to maintain satisfactory connection to ~~the SingTel~~each other's Network. It generally provides the fault handling procedures related to the Network. Procedures for carrying out planned engineering works, testing and monitoring are also described in this Section.

SingTel must modify Clause 1 to reflect the fact that both Licensees must take actions to ensure satisfactory physical interconnection.

SingTel comments: **Agreed.**

CLAUSE 2 – CONDITIONAL APPROVAL

2. FAULT HANDLING PROCEDURES

2.1 General

- 2.1.1 Prior to activating the fault handling procedures, the Party reporting the fault (**reporting Party**) must reasonably establish that a genuine fault exists and also that every effort has been made to prove that the fault is not within the reporting Party's side of the POI.
- 2.1.2 Faults related to the Local Leased Circuits from SingTel is not covered in this RIO Agreement and its Annexes. The Requesting Licensee is responsible for the Local Leased Circuit. It is the Requesting Licensee's responsibility to ensure that the fault does not lie within its side of the POI, including fault relating to the Interconnection Link before reporting the fault to SingTel under this RIO Agreement.
- 2.1.3 Each Party shall maintain its own fault reporting centre which shall be responsible for handling the faults between Networks, coordinating the fault clearance (including escalations) within its own Network and subsequently reporting the clearance of the fault to the other Party. Appendices 1 and 2 contain details of both Parties fault reporting centres.

- 2.1.4** Both Parties shall co-operate in any investigation and follow up actions and keep each other informed on the status of the progress of the fault clearance in a timely manner.
- 2.1.5** Each Party shall establish 24 hour contact points for fault reporting at its nominated fault reporting centre. [Annexes 1 & 2] contain information on the contact points of the Parties for such purpose.

2.2 Type Of Faults

2.2.1 Faults reported may be classified as follows:

- (i) Signalling Link faults; and
- (ii) Gateway Switch Network faults.

2.2.2 Signalling Link Faults

2.2.2.1 All Signalling Links provided by SingTel shall be supervised closely by the Requesting Licensee and report any fault to the reporting centre of SingTel as soon as possible.

2.2.3 Gateway Switch Network Faults

2.2.3.1 Faults related to the IGS/SGS or Licensee's system shall be referred to the related IGS/SGS Switch during office hours, or NMC during after office hours.

CLAUSE 3 – CONDITIONAL APPROVAL

SingTel may also wish to specify procedures to be used in the event that it requires access to the Requesting Licensee's network in an emergency situation.

SingTel comments: See procedures below dealing with Major Service Interruptions.

SingTel comments: The following procedures are included to address IDA's concerns regarding the adequacy of fault reporting performance levels, as identified in relation to clause 8.2 of the main body of the RIO Agreement.

2.3 Interconnect Fault Status

2.3.1 When a Party reports a fault to the other Party, they shall agree the classification of the fault reported, i.e. whether it is service affecting or non-service affecting. They will also exercise their judgement and discretion and agree upon whether a non-service affecting fault could eventually develop into a service affecting fault.

2.3.2 Service affecting fault(s) may cause service interruption to the Customers when Interconnected Calls conveyed between the Networks encounter great difficulty in completion. Failure of more than one-third of the Interconnect Links, breakdown of major cable plant, loss of SS7 signalling linkset which are all likely to result in

various degrees of service interruption shall be included in the classification of service affecting fault(s).

2.3.3 Non-service affecting fault(s) are those that do not adversely affect the Call handling capability of the Network to complete the Interconnected Calls. Failure of less than one-third of the Interconnect Links or the loss of SS7 Signalling Links (not affecting the signalling linkset) shall be included in the classification of non-service affecting fault(s) unless otherwise agreed by both Parties to upgrade it to service affecting fault(s).

2.3.4 Table 3.1 below shows the target response time for service affecting and non-service affecting fault(s).

2.4 Handling Of Faults

2.4.1 Interconnect Link faults (excluding SS7 Signalling Link faults)

(a) Faults due to optical fibre breakdown, SDH equipment failure or other related equipment in the IGS/SGS which causes the unavailability of an Interconnect Link, that does not carry an SS7 Signalling Link, shall constitute an Interconnect Link fault.

(b) Interconnect Link faults that affect less than one-third of the working capacity of the relevant Interconnect Link shall be included in the classification of non-service affecting fault(s). Interconnect Link faults that affect one-third or more of the working capacity of the relevant Interconnect Link shall be included in the classification of service affecting fault(s).

2.4.2 Signalling Link Faults

All Signalling Links provided by the Party shall be supervised closely by the Party and report any fault to the reporting centre of other Party as soon as possible. Signalling Link failures that do not affect the operation of the signalling linkset shall be considered as non-service affecting. Signalling linkset failure shall be considered as service affecting.

2.4.3 IGS/SGS Network Faults

Faults related to the IGS/SGS equipment may have effect on the conveyance of Interconnected Calls between the Networks. If such IGS/SGS fault cannot be cleared

by normal fault clearance procedures by the Party/Parties concerned, then it will be reported to the higher level following the fault escalation procedure.

3. TARGET RESPONSE TIMES

3.1 The target response time for attendance to an alarm or reported fault will depend on the time of its occurrence as contained in Table 3.1 below. Office Hours is defined as 8am to 5pm for Monday to Friday (except Public Holiday). The whole of Saturday, Sunday and any Public Holiday and the hours outside the Office Hours are referred to as “After Office Hours”.

<u>Fault Type</u>	<u>Response Time</u>	
	<u>During Office Hours</u>	<u>After Office Hours</u>
<u>Service Affecting</u>	<u>within 1 (one) hour of receipt of notification</u>	<u>within 2 (two) hours of receipt of notification</u>
<u>Non-Service Affecting</u>	<u>within 2 (two) hours of receipt of notification</u>	<u>within next Working Day of receipt of notification</u>

Table 3.1 - Target Response Time

4. FAULT ESCALATION

4.1 Procedure

4.1.1 Where a fault persists and the Parties agree that progress of the remedy is not satisfactory, the fault may be escalated according to the fault escalation timescales and escalation reporting levels as outlined in sub-clauses 4.2 and 4.3 herein respectively.

4.1.2 The Parties shall immediately inform the first level of escalation within the respective Party's organisation at the same time when the Party detected the fault notifies the fault reporting point of the Party for action.

4.1.3 The Parties shall maintain the communication links at the affected site(s) and report on the progress of the restoration work.

4.2 Fault Escalation Timescales

4.2.1 The Parties shall use the following timescales as guidelines for the fault escalation process. The timescales shall be used in deciding whether the restoration of a fault is being progressed satisfactorily. If the escalation time has expired and both Parties are satisfied with the progress of the fault restoration, then no immediate escalation is necessary.

<u>Fault Type</u>	<u>Maximum Time For Escalation (Commencing after the Response Time)</u>		
	<u>First Level</u>	<u>Second Level</u>	<u>Third Level</u>
<u>Service Affecting</u>	<u>Immediate</u>	<u>2 (two) hours</u>	<u>4 (four) hours</u>
<u>Non-Service Affecting</u>	<u>Immediate</u>	<u>8 (eight) hours</u>	<u>24 (twenty-four) hours</u>

Table 4.2 – Fault Escalation Timescales

4.3 Escalation Reporting Levels

4.3.1 All requests for escalation shall be notified through each Party's fault reporting point. The reporting levels are :

<u>Operator</u>	<u>SingTel</u>	<u>Requesting Licensee</u>
<u>Escalation Level</u>		
<u>First</u>	<u>Switch Engineer</u>	<u>to be advised by Requesting Licensee</u>
<u>Second</u>	<u>Interconnect Operations Manager</u>	<u>to be advised by Requesting Licensee</u>
<u>Third</u>	<u>Operations Director</u>	<u>to be advised by Requesting Licensee</u>

Table 4.3 - Escalation Reporting Levels

4.4 Persistent or Repeated Faults

4.4.1 Persistent or repeated faults or issues which cannot be resolved satisfactorily through the normal channels of the Parties shall be escalated to the Second Level to expedite the fault clearance process.

4.5 Escalation Problems

4.5.1 The Parties shall notify their respective and appropriate officers stated in Table 4.3 above for problems encountered in implementing or execution of the fault escalation procedures.

5. MAJOR SERVICE INTERRUPTION (MSI)

5.1 General

5.1.1 Major service interruption (MSI) is defined as a fault or problem which results in the inability of the available circuits on an interconnect route and has a major impact on the service offered to either Party's Customers. MSI is therefore classified as service affecting. Examples of MSI are as follows:

- (a) An extensive lineplant failure.
- (b) A major failure of SDH system terminating at the Interconnect Links.
- (c) Total loss of the signalling and/or synchronisation of the Interconnect Links.

5.2 Procedures

5.2.1 The Party encountering a MSI shall notify the other Party through fax and phone Call or other means providing real-time communication between the Parties. This should take place within 30 minutes of the MSI becoming known to the Party.

5.2.2 Direct communication links shall be established between the Parties' interconnect fault reporting centres (set up as per sub-clause 2.1.3 above). The communication links shall facilitate the effective exchange of information and progress reports. Communication liaison officers shall be appointed to maintain and man the communication links.

5.2.3 The Party responsible for clearing the MSI shall provide to the other Party regular updates of the progress through the communication links established according to sub-clause 5.2.2 above.

5.2.4 The Party responsible for clearing the MSI fault shall inform the other Party through the communication links within 30 minutes upon clearance of the MSI fault.

3.6. PLANNED ENGINEERING WORKS

3.16.1 For any planned engineering works within the Requesting Licensee's Network, which will result in momentarily outage of service of the local leased circuit, SS7 Signalling Links, or Gateway Exchange, the Requesting Licensee shall inform SingTel through the contact points, by fax, given in Appendices 1 & 2.

3.26.2 The details of the works to be carried out shall be recorded on an "Advice of Planned Engineering Work" form, (**Advice form**). The Advice form as provided in Appendix 3 shall state the date, time and duration of such works, the impact to the conveyance of Calls between the Parties' Network, any Network management procedures required, and contingency measures to be taken by either Party or both Parties. The schedule and duration of the planned work proposed by the Requesting Licensee shall be agreed by SingTel before the commencement of such works.

3.36.3 The Requesting Licensee, prior to performing the planned engineering works, shall give advance notice of at least five (5) Business Days to the other Party.

3.46.4 The preferred times and duration allowed for carrying out various planned engineering works shall be between 0100 through 0500 hrs, applicable on everyday, including public holiday.

3.56.5 The Requesting Licensee shall notify SingTel that the works have been completed by completing and fax to SingTel, the last section of the Advice form.

CLAUSE 4 – CONDITIONAL APPROVAL

4.7. TESTING AND MONITORING

4.17.1 The Requesting Licensee shall be responsible to test and monitor the performance of its own Network. Testing of the Interconnection Link and Signalling Links shall be kept to a minimum and shall avoid the busy hour periods. No testing shall be carried out before SingTel agreed to the conduct such tests, including any routine tests.

4.27.2 For handling problems which can only be localised through a series of test Calls (eg difficulty in reaching certain number groups), both Parties shall agree upon the details of the testing required. Test numbers and contact points shall be exchanged to facilitate the testing.

APPENDIX 1 – CONDITIONAL APPROVAL

APPENDIX 1

1 Notification Points for Contact in SingTel:-

- (a) SingTel Network Management Centre (NMC) (after office hours)

Location :

Telephone :

Facsimile :

Supervisor :

- (b) SingTel IGS/SGS

Location :

Telephone :

Facsimile :

Supervisor :

APPENDIX 2 – CONDITIONAL APPROVAL

APPENDIX 2

1 Notification Contact Points in Requesting Licensee

- (a) Requesting Licensee’s Network Management Centre (NMC) - 24 hours

Location :

Telephone :

Facsimile :

Supervisor :

- (b) Name of Requesting Licensee’s Network Location:

Location :

Telephone :

Facsimile :

Supervisor :

APPENDIX 3 – CONDITIONAL APPROVAL**APPENDIX 3****Advice of Planned Engineering Works**

Subject:	<i>Title of the planned works</i>
Switch/ Location:	<i>Indicate the Switch or location of the planned work</i>
Type of planned works:	<i>Signalling Link /Interconnection Link/Exchange</i>
Outage Date:	<i>Indicate the date of the planned work</i>
Outage Time:	<i>Indicate the start time of the planned work.</i>
Service Interruption Duration:	<i>Provide an estimated duration on the service interruption</i>
Number of local leased circuit/ Signalling Links affected:	<i>Indicate the number and system ID of the local leased circuit or Signalling Links affected by the planned work</i>
Effect of planned work:	<i>Describe the effect of the planned works on Calls and in which direction</i>
Reason of planned work:	<i>Describe the reason for the planned works eg due to routine/urgent maintenance or software upgrade etc</i>
Remarks:	<i>To include additional comments or remarks eg Preparation work will commence at around “time” on “date”</i>
Issuing Officer:	<i>Indicate the name and designation of the officer issuing the advice of planned work.</i>