

SCHEDULE 1

ANNEXURES

ANNEX A
SECTION 1

SECTION 1 - CCS NO. 7 SIGNALLING SYSTEM (MTP & ISUP) INTERFACE SPECIFICATION

1 General

1.1 The CCS No.7 signalling system interface shall conform to the following:

(A) MTP following ITU-T Rec. Q.701 - Q.707; and

(B) ISUP following ITU-T Rec. Q.761 to Q.764 and Q.766 to support basic bearer service and supplementary services for voice and non-voice applications.

1.2 The interface specifications contained in this section are based on the interworking with SingTel's IGS/SGS.

A MTP

A1 STRUCTURE

A1.1 The MTP shall conform to ITU-T Rec. Q.701-Q.707 and comprise of three (3) functional levels. The structure of the MTP is given below.

A1.2 The MTP shall allow messages from all different users to be transferred on the same signalling data link.

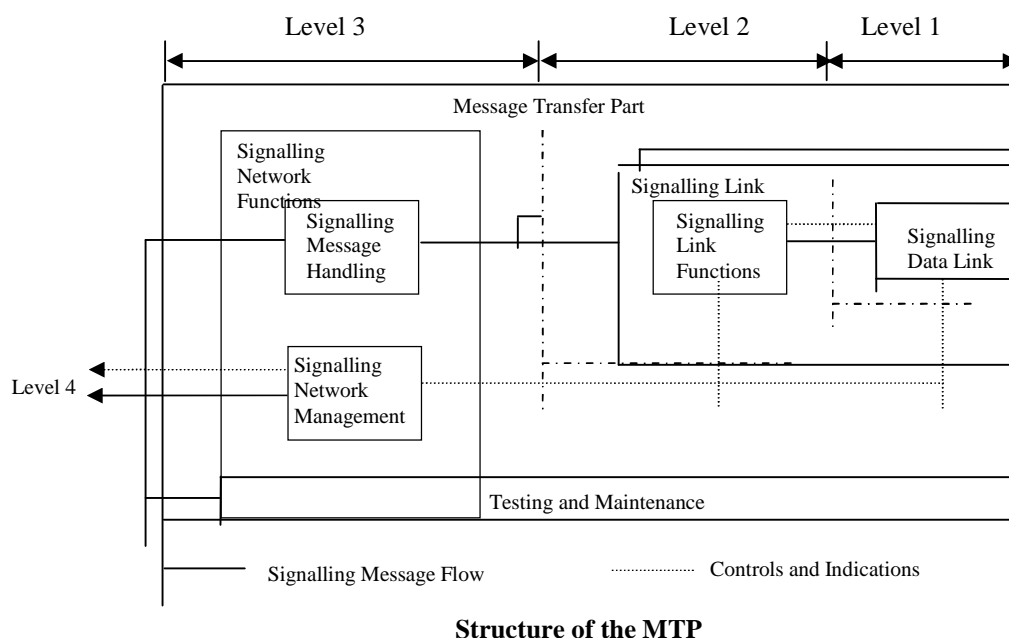

A2 SIGNALLING DATA LINK (MTP LEVEL 1)

A2.1 Requirements

The Signalling data link (MTP Level 1) shall conform to all requirements as specified in ITU-T Rec. Q.702.

A2.2 Digital Signalling Data Link

- (a) A signalling data link shall comprise two (2) data channels operating together in opposite direction at 64 kbit/s which are to be derived from TS 16 of the 2048 kbit/s PCM interface.
- (b) The data link shall be assignable by command to any speech channel (time-slot) available for 64 kbit/s user transmission if the standard time slots are not available.

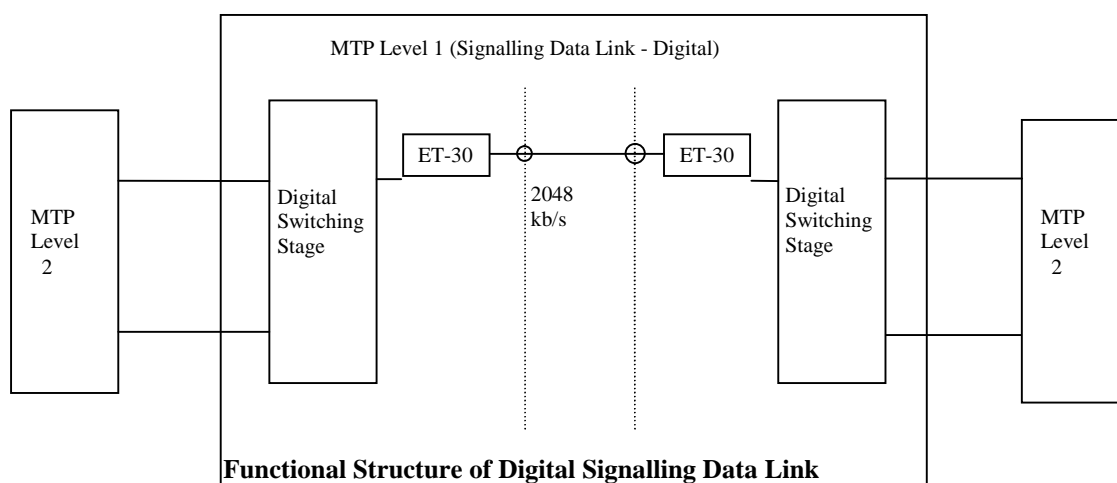

A3 SIGNALLING LINK (MTP LEVEL 2)

A3.1 Requirements

- (a) The Signalling Link (MTP Level 2) shall fulfil the requirements in all details as specified by ITU-T Rec. Q.703.
- (b) A single flag shall be sent between consecutive signal units. However, the exchange shall accept signal units which are delimited by either single flag or multiple flags.

- (c) The Signalling Link shall cater for messages with signalling information field of up to 272 octets. This shall allow a single message signal unit to accommodate information blocks of up to 268 octets in length accompanied by a routing label.
- (d) The spare bits in the link status signal unit shall be coded '0' and shall be ignored at the receiving side.
- (e) Basic error correction method shall be used in the exchange. For satellite connection, the preventive cyclic method shall be available.
- (f) Level 2 flow control shall be provided in the exchange. The exchange shall prevent excessive oscillation between congested and non-congested states when performing level 2 flow control.
- (g) The values of MTP level 2 timers (T1-T7) shall conform to the range/values as specified in ITU-T Rec. Q.703.

A4 SIGNALLING NETWORK FUNCTIONS (MTP LEVEL 3)

A4.1 Requirements

The MTP Level 3 shall include all signalling Network functions as specified in ITU-T Rec. Q.704.

A4.2 Signalling Message Handling

(a) Message Routing Function

- (i) The routing label shall be used for message routing purpose. It shall be possible to provide different routing plans for different user parts using the service indicator.
- (ii) The routing (eg outgoing Signalling Linksets) for a specific routing label shall be defined by command.
- (iii) The exchange acting as SP shall provide load-sharing between links belonging to the same link set for signalling traffic to be sent to a particular signalling point.

(b) Message Distribution

The exchange shall analyse the service indicator to determine which user part the message is to be delivered.

(c) Message Discrimination

The exchange shall analyse the destination code in the routing label to determine whether or not the exchange is the destination point of that message as specified in ITU-T Rec. Q.704.

A4.3 Signalling Network Management

(a) SP Congestion

The exchange shall conform to ITU-T Rec. Q.704 procedures to detect and handle SP congestion.

(b) Signalling Network Congestion

Based on the international standard of flow control, the congestion status shall be provided for the indication of Signalling Link or signalling route set congestion. Under normal operation, when the Signalling Link or route set is not congested, the congestion status is assigned the zero value. The setting of congestion onset, abatement and discard threshold(s) shall conform to ITU-T Rec. Q.704.

A4.4 Signalling Traffic Management

(a) Under normal situations, the signalling traffic to be sent to a particular signalling point shall be evenly distributed over all available Signalling Links within the link set.

(b) Changeover/Changeback

(i) It must be ensured that no messages are lost, duplicated or out-of-sequence during the changeover/changeback procedures. In the changeover procedure, the exchange shall divert traffic pertaining to that unavailable Signalling Link to the alternative Signalling Link with next priority in the same link set.

(ii) Time-controlled changeover shall be used when the exchange of a changeover message is not possible or not desirable.

(c) Management Inhibiting

(i) The exchange shall provide Signalling Link management inhibiting function for maintenance or testing purposes (eg if the link experiences too many changeovers/changebacks in a short time, or there is a significant link error

rate). A Signalling Link marked 'inhibited' shall be unavailable to user part-generated signalling traffic. The management inhibit action shall not cause any link status change at level 2. Inhibit request shall only be granted provided that the inhibit action does not cause any previously accessible destinations to become inaccessible at either end of the Signalling Link.

- (ii) Periodic tests shall be made on the inhibit status of inhibited links. Such periodic tests shall not overload the signalling Network and shall not perform at signalling point restart.
- (iii) Uninhibiting shall be initiated either by management function or by routing functions at either end of the Signalling Link.
- (d) Signalling Traffic Flow Control
 - (i) The exchange shall provide signalling traffic flow control function to limit signalling traffic at its source in the case when the signalling Network is not capable of transferring all traffic offered by the user because of Network failures or congestion situation. The flow control shall also initiate resumption of the normal traffic flow when the normal transfer capability is restored.
 - (ii) When an MTP user has become unavailable, the MTP shall not send a User Part Unavailable (UPU) message to the partner signalling points. Signalling messages received from the affected user parts of the partner signalling points shall be discarded as long as the local user parts are not available.

Upon receipt of an UPU message, the MTP shall discard these messages.

A4.5 Signalling Link Management

The exchange shall provide Signalling Link management functions as specified in ITU-T Rec. Q.704 to initiate and control actions aimed at restoring the normal availability of links and link sets.

A4.6 Signalling Route Management

The exchange shall provide signalling route management function as specified in ITU-T Rec. Q.704 to transfer information about changes in the availability of signalling routes in the Signalling Network so as to enable remote SPs to take appropriate signalling traffic management actions.

A4.7 Format and Codes of Signalling Network Management Messages

- (a) The label structure of Signalling Network Management messages coincides with the standard routing label as follows:

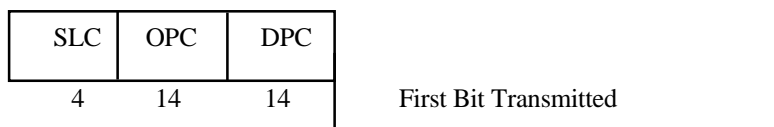

The Signalling Link Code (SLC) indicates the Signalling Link, connecting the destination and originating points, to which the message is related. It is coded as 0000 for messages not related to a Signalling Link.

- (b) A list of heading code allocation of Signalling Network Management messages are given in Table A4-1 hereof.

A4.8 Time-out Values and Tolerances

The exchange shall provide MTP level 3 timers with values and tolerances as specified in ITU-T Rec. Q.704.

Message	H1	0000	0001	0010	0011	0100	0101	0110	0111	1000	1001	1010	1011	1100	1101	1110	1111
	H0																
	0000																
CHM	0001		COO	COA			CBD	CBA									
ECM	0010		ECO	ECA													
FCM	0011			TFC													
TFM	0100		TFP				TFA										
RSM	0101		RST														
MIM	0110		LIN	LUN	LIA	LUA	LID	LFU	LLT	LRT							
TRM	0111		TRA														
	1000																
	1001																
	1010																
	1011																
	1100																
	1101																
	1110																
	1111																

CHM = Changeover and Changeback Message FCM = Signalling-Traffic-flow-control Messages
 ECM = Emergency Changeover Message TFM = Transfer-prohibited-transfer-allow-transfer-restricted Messages
 RSM = Signalling-route-set-test Messages MIM = Management-inhibit Messages
 TRM = Traffic-restart-allowed Messages

Table A4-1: Heading Code Allocation of Signalling Network Management Messages

A5 MESSAGE TRANSFER PART SIGNALLING PERFORMANCE

- A5.1 The exchange MTP shall achieve a signalling performance as specified in ITU-T Rec. Q.706.
- A5.2 The exchange CCS No.7 signalling equipment shall be highly reliable such that not more than one in 10^7 messages will be lost due to failure in the MTP. Other performance factors (eg changeover performance times, etc.) shall also be conformed to.

A6 TESTING AND MAINTENANCE

- A6.1 The exchange shall provide Signalling Network testing and maintenance requirements as specified in ITU-T Rec. Q.707.
- A6.2 An on-line Signalling Link test shall be applicable to Signalling Link to be activated or restored. The Signalling Link becomes available only if the test is successful. It shall be able to send Signalling Link test messages at regular intervals on an in-service Signalling Link using command.
- A6.3 The Signalling Network testing and maintenance messages shall be carried on the signalling channel in message signal units with service indication '0001'.
- A6.4 The exchange shall provide timers in ITU-T Rec. Q.707.

B ISUP SPECIFICATION

B1 ISUP Addressing

The ISUP address structure shall be capable of handling E.164 addresses in the Calling and Called number, and re-directing address information elements.

B2 Message Formats and Codes

- B2.1 Basic ISUP messages and signalling information as defined in ITU-T Rec. Q.762 with their formats and contents as specified in ITU-T Rec. Q.763 shall be provided. The encoding of the message types and parameter names are as shown in Table B2-1 and Table B2-2 respectively. Additional ISUP messages and parameters may be provided to support ISDN supplementary services defined in ITU-T Rec.73X-series.

Message Type			Coding
ACM	-	Address complete	00000110
ANM	-	Answer	00001001
BLO	-	Blocking	00010011
BLA	-	Blocking acknowledgment	00010101
CPG	-	Call progress	00101100
CGB	-	Circuit group blocking	00011000
CGBA	-	Circuit group blocking acknowledgment	00011010
CQM	-	Circuit group query	00101010
CQR	-	Circuit group query response	00101011
GRS	-	Circuit group reset	00010111
GRA	-	Circuit group reset acknowledgment	00101001
CGU	-	Circuit group unblocking	00011001
CGUA	-	Circuit group unblocking acknowledgment	00011011
CFN	-	Confusion	00101111
CON	-	Connect	00000111
COT	-	Continuity (receive only)	00000101
FAA	-	Facility accepted	00100000
FRJ	-	Facility reject	00100001
FAR	-	Facility request	00011111
FOT	-	Forward transfer	00001000
INF	-	Information	00000100
INR	-	Information request	00000011
IAM	-	Initial address	00000001
REL	-	Release	00001100
RLC	-	Release complete	00010000
RSC	-	Reset circuit	00010010
RES	-	Resume	00001110
SAM	-	Subsequent address	00000010
SUS	-	Suspend	00001101
UBL	-	Unblocking	00010100
UBA	-	Unblocking acknowledgment	00010110
USR	-	User-to-user information	00101101
SingTel internal use			11111111

Table B2-1 : Encoding of the Message Types

Parameter Name	Coding
Access delivery information	00101110
Access transport	00000011
Automatic congestion level	00100111
Backward Call indicators	00010001
Call diversion information	00110110
Called Party number	00000100
Calling Party number	00001010
Calling Party's category	00001001
Cause indicators	00010010
Circuit group supervision message type indicator	00010101
Circuit state indicator	00100110
Connected number	00100001
Continuity indicators (received only)	00010000
End of optional parameters	00000000
Event information	00100100
Forward Call indicators	00000111
Information indicators	00001111
Information request indicators	00001110
Nature of connection indicators	00000110
Optional backward Call indicators	00101001
Optional forward Call indicators	00001000
Original called number	00101000
Range and Status	00010110
Redirecting number	00001011
Redirection number	00001100
Redirection number restriction	01000000
Redirection information	00010011
Signalling Point Code	00011110
Subsequent number	00000101
Suspend/Resume indicators	00100010
Transmission medium requirement	00000010
User service information	00011101
User-to-user indicators	00101010
User-to-user information	00100000
SingTel internal use	11101111 11110011 11110100 11111001 11111010 11111011 11111101 11111100

Table B2-2 : ISUP Parameter Name Codes

B2.2 The exchange shall conform to the default interpretations of recognised parameters which contain codes currently indicated as being spare in ITU-T Rec. Q.763. This is to ensure that the exchange shall be able to interwork with a future version of ISUP. The procedures for handling of the unrecognised parameter values shall follow ITU-T Rec. Q.764 and the guidelines for handling of unrecognised information follow ITU-T Rec. Q.767.

B3 Network Features

B3.1 The exchange shall make an automatic repeated attempt:

- (a) on detection of dual seizure if it is the non-control exchange;
- (b) on receipt of BLO after sending an IAM and before any backward message has been received;
- (c) on receipt of a RSC after sending an IAM and before a backward message has been received; and
- (d) on receipt of an unreasonable message during Call setup.

B3.2 The exchange shall provide BLO (UBL) message and CGB (CGU) to permit the switching system or maintenance system to remove (return) traffic from (to) the distant terminal(s) of a circuit or group of circuits because of a fault or to permit testing.

B3.3 Circuit group query test procedure shall be provided in the exchange to audit the circuit state on a demand or routine basis. The range field of the CQM shall range from N=0 (single circuit) to maximum 31. If this value is exceeded the CQM message shall be discarded.

B4 Basic Signalling Procedures

B4.1 The exchange shall conform to all requirements as specified in ITU-T Rec. Q.764 whether acting as an originating exchange, a transit exchange or a destination exchange.

B4.2 Normal Call Release

The exchange shall provide release procedures based on a two (2) message (release, release complete) approach.

- (a) The Release Message (**REL**) initiates release of the circuit switched connection and it is required that the circuit is re-selectable from the

subsequent exchange within the cross-office transfer time, TCU as specified in ITU-T Rec. Q.766.

- (b) Release Complete Message (**RLC**) shall be returned to the preceding exchange when the switched path is released and the circuit is re-selectable.

B4.3 Abnormal Condition

The exchange shall conform to ITU-T Rec. Q.764 on the handling of abnormal conditions which are listed below:

- (a) dual seizure;
- (b) transmission alarm handling for digital inter-exchange circuits;
- (c) reset of circuits and circuit groups;
- (d) failure in the blocking/unblocking sequence;
- (e) receipt of unreasonable signalling information message which includes:
 - (i) unexpected messages,
 - (ii) unrecognised signalling information messages,
 - (iii) unrecognised parameters,
 - (iv) unrecognised parameter values (both mandatory and optional),the exchange shall recognise all messages specified in Table B2-1;
- (f) failure to receive a RLC message;
- (g) failure to receive a response to an INR message; and
- (h) unable to release in response to a REL message.

B4.4 Automatic Congestion Control (**ACC**)

- (a) When the exchange reaches the overload condition, an automatic congestion level parameter shall be added to all REL messages generated by the exchange. This parameter indicates the level of congestion to the adjacent exchanges which in turn, shall reduce their traffic to the overload affected exchange.
- (b) If the exchange returns to its normal traffic load, it shall stop including automatic congestion level parameters in REL messages. The adjacent

exchanges shall then, after a predetermined time, automatically return to their normal status.

B5 Time Supervision

The exchange shall provide all timers specified in ITU-T Rec. Q.764.

B6 Performance of ISUP

The exchange shall achieve the ISUP signalling performance requirements as specified in ITU-T Rec. Q.766.

ISUP ATTACHMENT

1 ISUP CALL SET-UP SEQUENCE

The ISUP Call set-up sequence for the following traffic cases (all paths using CCS ISUP) is captured in this Attachment. The traffic cases shown here are not exhaustive.

The setting of parameters and indicators shown in this Attachment are tentative and subject to changes later.

<u>Item No.</u>	<u>Description</u>
1.1	Local Call - Successful Call Set-up Enbloc Operation; Terminating Access is ISDN
1.2	Enbloc Operation; Terminating Access is non-ISDN
1.3	Unsuccessful Call Set-up
1.4	Suspend and Resume Procedure

No.	1.1/1	Local Call – Successful Call Setup
		Enbloc Operation; Terminating access is ISDN

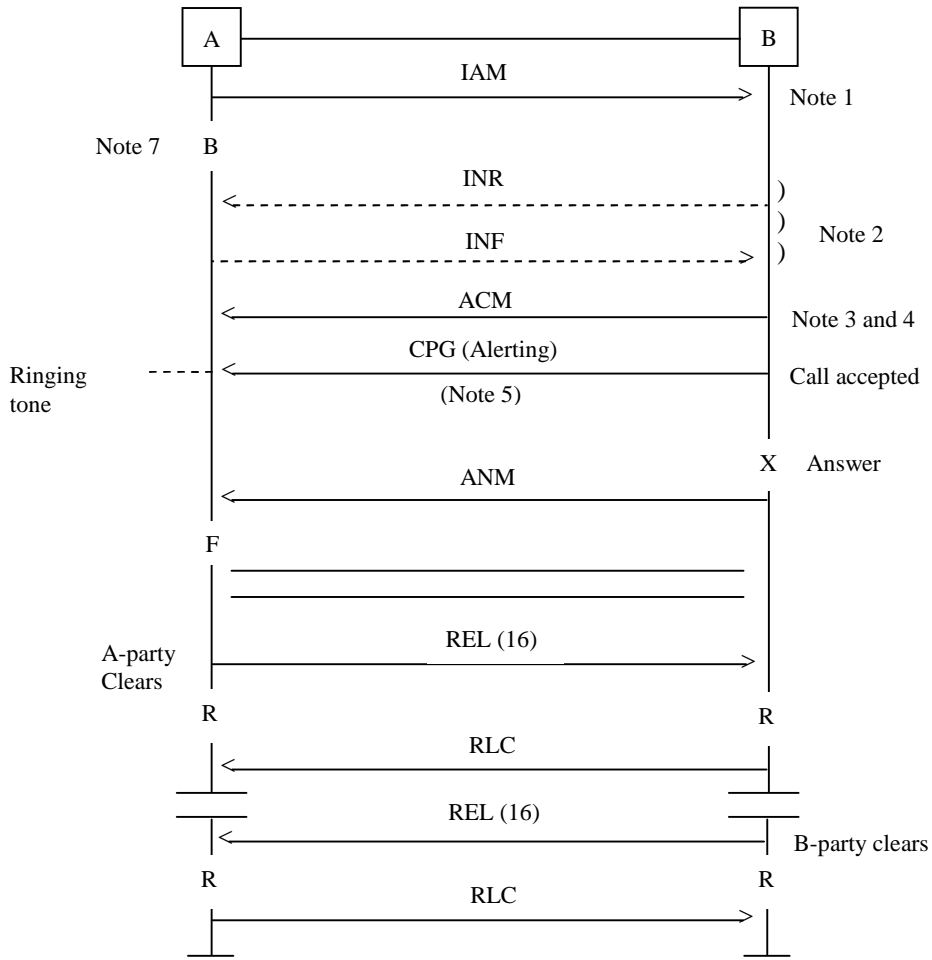

- Legend :
- X Switch path completed in both direction
 - R Remove switch path
 - B Switch path completed in backward direction
 - F Switch path completed in forward direction

No.	1.1/2	Local Call – Successful Call Setup																																										
		Enbloc Operation; Terminating access is ISDN																																										
<p>Note 1 :</p> <p>(a) CLI is always included in the IAM with an appropriate Presentation/Restriction/Not Available indication for the following traffic cases:-</p> <ul style="list-style-type: none"> - All originating Calls - Rerouted Calls - Transit Calls (Previous path is CCS-ISDNUP) <p>When the CLI is provided by the Network, the originating exchange sets the screening indicator to "Network provided". When the CLI is provided by the user or ISPBX, it is verified or screened for validity by the Network. If the user provided CLI is valid, the screening indicator is set to "user provided verified and passed". If the user provided CLI is not valid, the originating exchange defaults to the Network provided CLI.</p> <p>(b) The "ISDN User Part Preference Indicator" contained within the "Forward Call Indicator" of IAM is derived at the exchange from the bearer capability and supplementary service request contained in the Q.931 SETUP message.</p> <p>(c) The allocation of "Calling Party's Category" parameter field in the IAM is:-</p> <table style="border: none;"> <tr><td>0 0 0 0 0 0 0 0</td><td>Calling Party's category unknown at this time</td></tr> <tr><td>0 0 0 0 0 0 0 1</td><td>Operator, language French</td></tr> <tr><td>0 0 0 0 0 0 1 0</td><td>Operator, language English</td></tr> <tr><td>0 0 0 0 0 0 1 1</td><td>Operator, language German</td></tr> <tr><td>0 0 0 0 0 1 0 0</td><td>Operator, language Russian</td></tr> <tr><td>0 0 0 0 0 1 0 1</td><td>Operator, language Spanish</td></tr> <tr><td>0 0 0 0 0 1 1 0</td><td>)</td></tr> <tr><td>0 0 0 0 0 1 1 1</td><td>) Reserved</td></tr> <tr><td>0 0 0 0 1 0 0 0</td><td>)</td></tr> <tr><td>0 0 0 0 1 0 0 1</td><td>SingTel internal use</td></tr> <tr><td>0 0 0 0 1 0 1 0</td><td>Ordinary Calling Party</td></tr> <tr><td>0 0 0 0 1 0 1 1</td><td>Calling Party with priority</td></tr> <tr><td>0 0 0 0 1 1 0 0</td><td>Data Call (Voice band data)</td></tr> <tr><td>0 0 0 0 1 1 0 1</td><td>Test Call</td></tr> <tr><td>0 0 0 0 1 1 1 0</td><td>Spare</td></tr> <tr><td>0 0 0 0 1 1 1 1</td><td>Payphone</td></tr> <tr><td>0 0 0 1 0 0 0 0</td><td>)</td></tr> <tr><td>to</td><td>) Spare</td></tr> <tr><td>1 1 0 1 1 1 1 1</td><td>)</td></tr> <tr><td>1 1 1 0 0 0 0 0</td><td>Operator without trunk offering facility</td></tr> <tr><td>1 1 1 0 0 0 0 1</td><td>Coinafon</td></tr> </table>			0 0 0 0 0 0 0 0	Calling Party's category unknown at this time	0 0 0 0 0 0 0 1	Operator, language French	0 0 0 0 0 0 1 0	Operator, language English	0 0 0 0 0 0 1 1	Operator, language German	0 0 0 0 0 1 0 0	Operator, language Russian	0 0 0 0 0 1 0 1	Operator, language Spanish	0 0 0 0 0 1 1 0)	0 0 0 0 0 1 1 1) Reserved	0 0 0 0 1 0 0 0)	0 0 0 0 1 0 0 1	SingTel internal use	0 0 0 0 1 0 1 0	Ordinary Calling Party	0 0 0 0 1 0 1 1	Calling Party with priority	0 0 0 0 1 1 0 0	Data Call (Voice band data)	0 0 0 0 1 1 0 1	Test Call	0 0 0 0 1 1 1 0	Spare	0 0 0 0 1 1 1 1	Payphone	0 0 0 1 0 0 0 0)	to) Spare	1 1 0 1 1 1 1 1)	1 1 1 0 0 0 0 0	Operator without trunk offering facility	1 1 1 0 0 0 0 1	Coinafon
0 0 0 0 0 0 0 0	Calling Party's category unknown at this time																																											
0 0 0 0 0 0 0 1	Operator, language French																																											
0 0 0 0 0 0 1 0	Operator, language English																																											
0 0 0 0 0 0 1 1	Operator, language German																																											
0 0 0 0 0 1 0 0	Operator, language Russian																																											
0 0 0 0 0 1 0 1	Operator, language Spanish																																											
0 0 0 0 0 1 1 0)																																											
0 0 0 0 0 1 1 1) Reserved																																											
0 0 0 0 1 0 0 0)																																											
0 0 0 0 1 0 0 1	SingTel internal use																																											
0 0 0 0 1 0 1 0	Ordinary Calling Party																																											
0 0 0 0 1 0 1 1	Calling Party with priority																																											
0 0 0 0 1 1 0 0	Data Call (Voice band data)																																											
0 0 0 0 1 1 0 1	Test Call																																											
0 0 0 0 1 1 1 0	Spare																																											
0 0 0 0 1 1 1 1	Payphone																																											
0 0 0 1 0 0 0 0)																																											
to) Spare																																											
1 1 0 1 1 1 1 1)																																											
1 1 1 0 0 0 0 0	Operator without trunk offering facility																																											
1 1 1 0 0 0 0 1	Coinafon																																											

No.	1.1/3	Local Call - Successful Call Setup
		Enbloc Operation; Terminating access is ISDN
		<p>1 1 1 0 0 0 1 0 SingTel internal use</p> <p>1 1 1 0 0 0 1 1 SingTel internal use</p> <p>1 1 1 0 0 1 0 0 SingTel internal use</p> <p>1 1 1 0 0 1 0 1 PBX</p> <p>1 1 1 0 0 1 1 0 PBX with priority</p> <p>1 1 1 0 0 1 1 1)</p> <p>1 1 1 0 1 0 0 0)</p> <p>1 1 1 0 1 0 0 1) SingTel internal use</p> <p>1 1 1 0 1 0 1 0)</p> <p>1 1 1 0 1 0 1 1)</p> <p>1 1 1 0 1 1 0 0)</p> <p>to) Spare for national use</p> <p>1 1 1 1 1 1 1 0)</p> <p>1 1 1 1 1 1 1 1 Spare</p> <p>Note 2: INR/INF invoked (by end-to-end signalling) for Calls to transfer Information not included in the IAM</p> <p>Note 3: When no status indication has been received from the ISDN access prior to the destination exchange determining that the complete Called Party number has been received, the indicators in the ACM will be set as follows:-</p> <ul style="list-style-type: none"> - Called line status = 'NO INDICATION' - ISDN access indicator = 'ISDN' <p>Subsequently, the indication that the destination user is being alerted is transferred in a CPG message which contains an Event indicator set to 'Alerting'.</p> <p>Note 4: When connections are set-up to terminals having an automatic answer feature, the alerting indication may not be received from the Called Party. If a destination exchange receives an answer indication a ANM message is sent provided that an ACM has been sent; otherwise the CON message is sent (This CON then signifies both address complete and answer conditions). Indicators in CON will indicate 'SUBSCRIBER FREE' and 'ISDN' access. The destination exchange will through connect before CON is sent.</p>

No.	1.1/4	Local Call - Successful Call Setup
		Enbloc Operation; Terminating access is ISDN
<p>Note 5 : For telephone Calls within the ISDN, ringing tone will be applied by the terminating exchange as soon as it is known that the subscriber is free.</p> <p>Note 6 : The Answer message received from the destination exchange shall carry a charging indication.</p> <p>Note 7 : <u>Completion of Transmission Path</u></p> <p>(a) At the originating exchange, on speech or 3.1 kHz audio Calls, through-connection of the transmission path will be completed in both directions immediately after the IAM has been sent. For other connection types, through-connect of the transmission path will be completed in the back-ward direction (The transmission path is completed in the forward direction on receipt of a CON or ANM message) immediately after the sending of IAM.</p> <p>(b) At the intermediate exchange (No interworking encountered), through-connection of the transmission path in both directions will be completed after IAM has been sent.</p>		

No.	1.2	Local Call - Successful Call Setup
		Enbloc Operation; Terminating access is non-ISDN

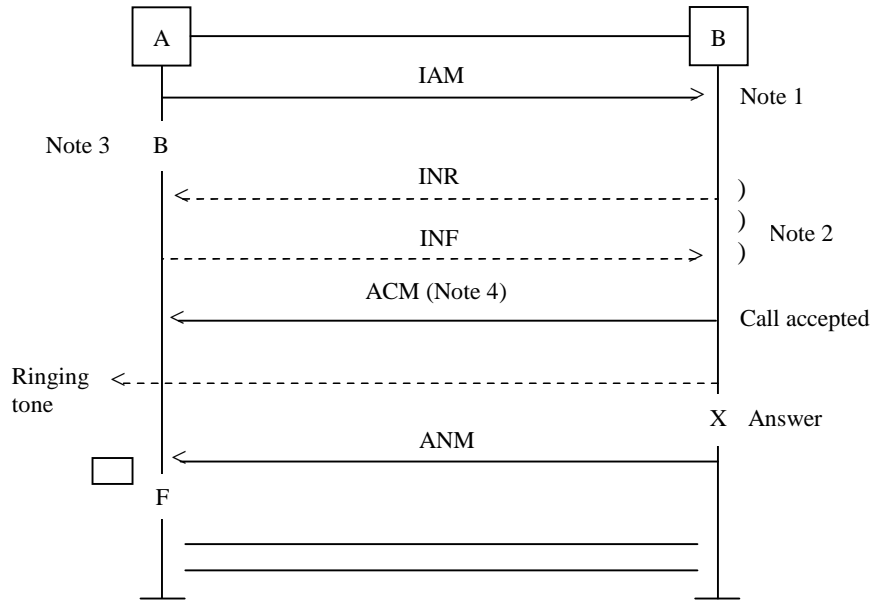

Note 1) See Case 1 of item 1.1

Note 2)

Note 3 : See Note 7 of Case 1, item 1.1

Note 4 : (a) An ACM shall be sent as soon as the destination exchange has determined that the complete Called Party number has been received, and the destination exchange established that the subscriber is free.

Indicators in the ACM will be set to indicate:-

- Called line status = 'SUBSCRIBER FREE'
- ISDN access indicator = 'NON ISDN'

(b) In the case of a PBX, an ACM shall be sent as soon as it has determined that the complete Called Party number has been received.

Indicators in ACM will be set to indicate:-

- Called line status = 'NO INDICATION'
- ISDN access indicator = 'NON ISDN'

No.	1.3/1	Unsuccessful Call Setup

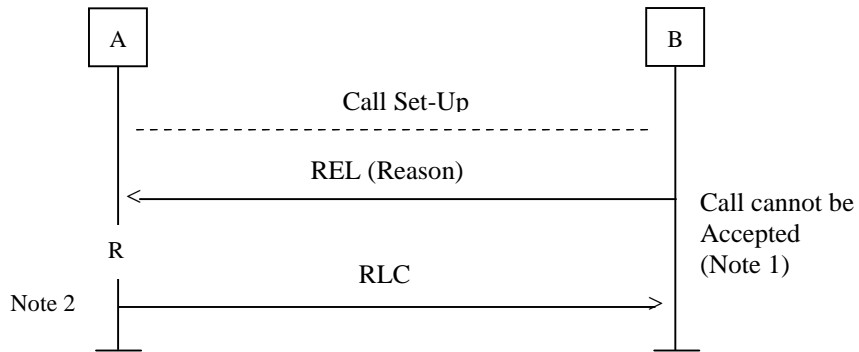

Note 1: If at any time in the Call setup the connection cannot be completed a release message which contains the reason is returned. The initiating exchange shall release the switched path (if established).

Note 2: On receipt of REL, the originating exchange releases the Switch path. In addition, it (if applicable)

- (a) returns an indication (in-band or out-band) to the Calling Party;
- (b) attempts to re-route the Call setup.

When the A-exchange is ready for circuit re-selection, a RLC is sent to the succeeding exchange.

Note 3: Some Unsuccessful Calls are listed below:-

	<u>Call Conditions</u>	<u>Cause Value</u>
(a)	Unallotted (unassigned); Temporary disconnect; Terminating denied	1
(b)	Subscriber line busy, no Call waiting service or engaged in CW service	17
(c)	Ringing no reply	19
(d)	Calls rejected or not accepted due to SCR, SCA or incoming access bar service	21
(e)	Address incomplete	28

No.	1.3/2	Unsuccessful Call Setup
<p style="text-align: center;"><u>Call Conditions</u></p>		<p style="text-align: center;"><u>Cause Value</u></p>
(f)	Subscriber line blocked for maintenance and operational reasons	27
(g)	All outgoing routes/trunks busy (at tandem exchange or PBX-DID routes)	34
(h)	Switching equipment congestion	42
Note 4 :	<p>The exchange also recognizes all the cause values based on ITU-T Rec. Q.763. For other Unsuccessful Calls like double or multiple Call diversion not allowed, time-out which lead to Call failure, etc., it is possible to define other 'cause values' under national standard (coding standard of cause indicators = '10').</p>	

No.	1.4	Suspend and Resume Procedure
-----	-----	------------------------------

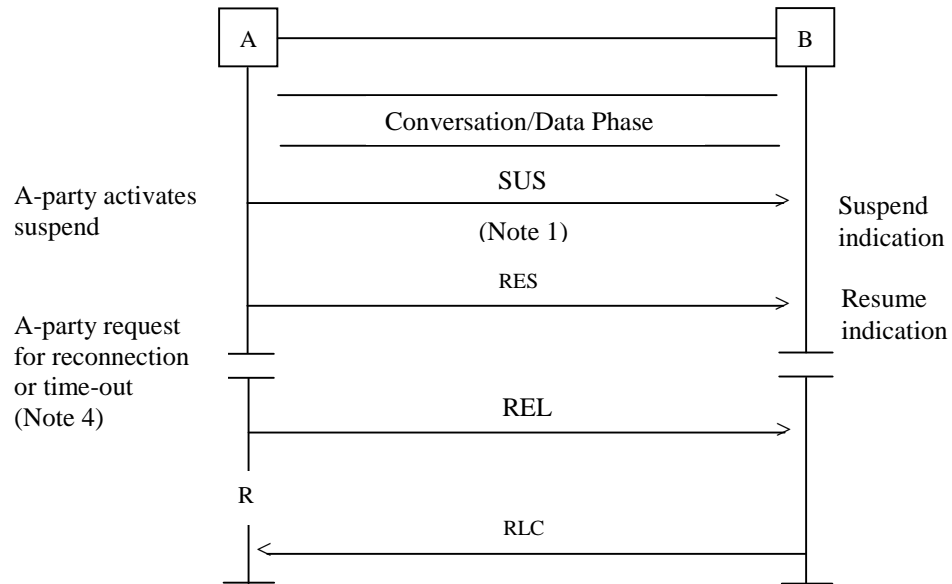

- Note 1 : The suspend message indicates a temporary cessation of communication without releasing the Call.
- Note 2 : The above procedure applies to suspend initiated by the Called Party, except that the functions at the originating and destination exchanges are transposed.
- Note 3 : A suspend message can also be generated by the Network in response to clear-back from a interworking node or an on-hook condition from a telephone Called Party. On the other hand, RES may be initiated by Network in response to a reanswer signal from an interworking point or an off-hook condition from an analogue Called Party.
- Note 4 : If a request for reconnection or a resume message is not received within timer (T2) or timer (T6), then the controlling exchange will initiate the release procedure.

ANNEX A

SECTION 1A

SECTION 1A: INTERCONNECT TESTING

1. TESTING PRINCIPLES

- 1.1 The purpose of the Interconnect Testing is to provide reassurance that each Party's Network can inter-work correctly with the other Party's Network and that the Interconnection will not adversely affect the existing services provided by each Party to their respective customers.
- 1.2 Interconnection to SingTel's Network shall be carried out and provision of Services under this RIO Agreement provided only after the satisfactory completion of the Interconnect Testing under this Annex and after SingTel is satisfied with the Interconnect Testing results in accordance with this Schedule.

2. PRE-REQUISITES FOR INTERCONNECT TESTING

- 2.1 Prior to the conduct of Interconnect Testing, the Requesting Licensee shall fully test its Network to ensure that it conforms to the Interface Specification as specified in Section 1 of Annex A. Any defects in hardware or software of the Requesting Licensee's Network so discovered must be corrected before the commencement of Interconnect Testing.

3. TESTING ITEMS

- 3.1 Interconnect Testing shall be carried out in accordance with SingTel's testing manuals. The Requesting Licensee shall perform Interconnect Testing in accordance with this Annex or as otherwise agreed by SingTel:
 - (i) where initial Interconnection, whether Physical Interconnection or Virtual (Distant) Interconnection, is to occur; or
 - (ii) where a new POI is to be established; or
 - (iii) where the Parties have agreed to implement a Network Change; or
 - (iv) prior to the reinstatement of a Service that has been suspended under clause 12 of the RIO Agreement; or
 - (v) where either Party has implemented new software or updated existing software that affects or is likely to affect Interconnection between the SingTel Network and the Requesting Licensee's Network.

4. TIMELINE FOR TESTING

- 4.1 The Requesting Licensee shall book the required test date and the testing duration at least one (1) month prior to the requested testing date. The Requesting Licensee shall submit the test order form as contained in the Attachment to SingTel to request Interconnect Testing. The test order form shall contain the necessary details for the testing setup, including the proposed test schedule and the requested test date.
- 4.2 SingTel shall advise the Requesting Licensee of the test date in writing within ten (10) Business Days of receipt of the test order form. If SingTel is not able to perform the testing on the requested test dates, SingTel shall counter-propose an alternative test schedule with the response and negotiate in good faith with the Requesting Licensee to arrange an alternative schedule.
- 4.3 The Parties shall act in good faith and make reasonable endeavours to complete all test items within the estimated testing period.
- 4.4 The requested testing duration is subject to mutual agreement by the Parties.
- 4.5 Any request for extension to the testing duration beyond the agreed time frame by the Requesting Licensee is subject to mutual agreement by both Parties. The Requesting Licensee shall make its request for extension at least two (2) Business Days prior to the end of the testing duration.
- 4.6 SingTel shall not be liable to the Requesting Licensee for any delay in completing all the test items unless such delay is directly attributable to the neglect or fault of SingTel.

5. DAILY TIME TABLE FOR INTERCONNECT TESTING

- 5.1 All Interconnect Testing shall be carried out during Business Days between 0900 hours and 1700 hours, with one (1) hour lunch break in between.

6. TESTING RESULTS

- 6.1 Connection of the Requesting Licensee's Network to SingTel's designated IGS/SGS shall be carried out only upon satisfactory completion of the Interconnect Testing in accordance with SingTel's interconnect manuals and after SingTel is satisfied with the Interconnect Testing results.

- 6.2 In the event that SingTel identifies a Critical Problem(s), the Requesting Licensee shall ensure that such problems are resolved within the testing period. Otherwise, the Requesting Licensee shall make booking for a new testing date to verify these Critical Problem(s) when solutions are available. Critical Problem refers to a problem affecting the conveyance of Interconnected Calls between SingTel's Network and the Requesting Licensee's Network including, but not limited to, problems that result from deviations by the Requesting Licensee from the specifications that it provided to SingTel.

7. CHARGES FOR INTERCONNECT TESTING

- 7.1 The Requesting Licensee shall pay SingTel the Charges specified in Schedule 9 for Interconnect Testing.
- 7.2 All Calls made during the Interconnect Testing shall be chargeable to the Requesting Licensee.

8. CANCELLATION AND DELAY IN TESTING

- 8.1 The Requesting Licensee shall adhere to the testing date and testing duration as approved by SingTel.
- 8.2 Any request for cancellation of Interconnect Testing shall be made in writing to SingTel and the Requesting Licensee shall pay SingTel the cancellation Charges in accordance with Schedule 9.
- 8.3 In the event that Interconnect Testing is completed or is terminated by the Requesting Licensee before the last day of the testing duration, the Requesting Licensee shall pay SingTel the Charges for the testing duration up to and including the day on which testing was completed or terminated and such other reasonable costs as may be incurred by SingTel as a result of early termination of the Interconnect Testing.
- 8.4 SingTel may unilaterally delay or postpone the testing date or duration due to matters outside SingTel's reasonable control. SingTel shall allocate a corresponding extension of the testing period for the number of days so delayed or allocate a new testing date for Interconnect Testing on a non-discriminatory basis. The Requesting Licensee shall not be liable to pay additional Charges for such extension period granted.

OPERATOR	
Name of Operator	Licence Type/Class
Business Address	
Postal Code:	
I wish to apply for SS7 Interworking Test	
For the period from _____ to _____. (____ Days)	
In support of my application, I provide the following Technical Information for the Setting up of Interconnect Testing	
For SS7 Testing	
4 Digit Access Code:	
Signalling Point Code:	
Circuit Direction:	

I confirm that we have a valid License from the Authority to operate telecommunication services. I agree that approval of this application is subject to SingTel's discretion and that SingTel reserves the right to decline the application or to make variation to the requested testing period without giving any reason.

I understand and agree that I shall execute the RIO Agreement prior to the conduct of the Interconnect Testing. I am liable for all charges that may arise from any delay or cancellation of Interconnect Testing should the RIO Agreement not be executed prior to the test.

I understand and agree that in addition to the charges for Interconnect Testing, all Calls made during the Interconnect Testing shall be chargeable to me.

I understand and agree that any request for cancellation of Interconnect Testing shall be made in writing to SingTel and I shall pay SingTel the cancellation charges as follows:

No. of calendar days (from the receipt of cancellation notice to the date of commencement of testing):	
<7	100%
7-13	80%
14-20	35%
>21	20%

I acknowledge that the interconnect testing may only be carried out subject to the Terms and Conditions of the RIO Agreement, and the Terms and Conditions of this Application. I agree to be bound by the said terms and conditions and in consideration of my application being approved. Upon approval, I agree to pay the charges as required.

I confirm that all the information given in making this application is true, correct and complete.

Signature

Designation

Name

Date

FOR SINGTEL USE

The application is Approved

Rejected

Reason for rejection: _____

Agreed Schedule for Interconnect Testing

from _____ to _____ . (____ Days)

SingTel SS7 Signalling information

Signalling Point Code

Signalling Mode

Signalling Timeslot

Signalling Link Code

Circuit Direction

Circuit Selection Order

Signature

Designation

Name

Date

ANNEX A

SECTION 2

SECTION 2 - SS7 INTERWORKING TESTING MANUAL

1 INTRODUCTION

1.1 GENERAL

1.1.1 This manual describes the test items for the SS7 testing, the testing principles and the criteria for successful testing.

1.1.2 The ITU-T Rec Q.78X referred to in this manual are the 1992 version.

2 TESTING ACTIVITIES

2.1 SS7 COMPATIBILITY TEST

2.1.1 The ITU-T Rec. Q.781 to Rec. Q.785 shall be used as guidelines for the following SS7 compatibility tests:-

- (a) MTP Level 2;
- (b) MTP Level 3;
- (c) ISUP Basic Call Control; and
- (d) ISUP Supplementary Services.

2.1.2 The above SS7 compatibility tests are described below and shall be performed in a test environment. The details can be found in Sections 2A to 2D of Annex A.

2.2 TEST CONFIGURATION

Signalling links are required to be connected as shown below. An SS7 Protocol Analyser shall be terminated across the two links to monitor and trap the SS7 messages exchanged between the two signalling points.

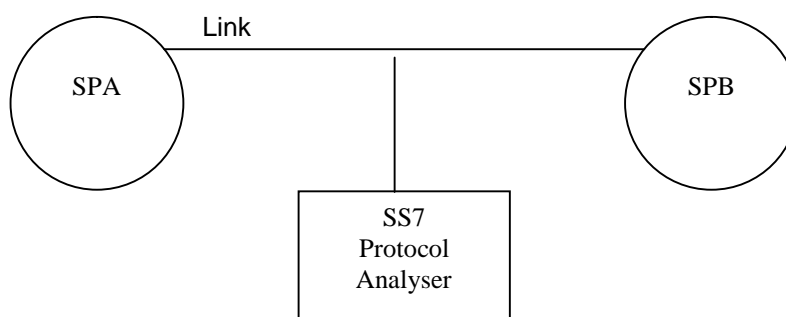

2.3 SS7 MTP LEVEL 2

2.3.1 The MTP level 2 test items are selected from the ITU-T Rec. Q.781 to confirm the protocol specified in Rec. Q.703.

2.3.2 The test items to verify normal/emergency alignment and activation/deactivation procedures are identified. Details of the tests can be found in Section 2A of Annex A.

2.4 SS7 MTP LEVEL 3

2.4.1 The MTP level 3 test items are selected from the ITU-T Rec. Q.782 to confirm the protocol specified in Rec. Q.704 and Rec. Q.707.

2.4.2 The test items to verify Signalling Link management, signalling message handling, changeover, changeback and Signalling Link test are identified. Details of the tests can be found in Section 2B of Annex A.

2.5 SS7 ISUP BASIC CALL CONTROL

2.5.1 The ISUP Basic Call Control Test are selected from ITU-T Rec. Q.784 to confirm the protocol specified in the ITU-T Rec. Q.761 to Rec. Q.764.

2.5.2 The test items to verify circuit supervision, normal Call setup, normal release, unsuccessful Call setup, and abnormal situations during a Call, special Call setup and various bearer services are identified. Details of the tests can be found in Section 2C of Annex A.

2.6 SS7 ISUP SUPPLEMENTARY SERVICES

2.6.1 The ISUP protocol test for supplementary services are selected from the ITU-T Rec. Q.785 to confirm the implementation of supplementary services in the ITU-T Rec. Q.730 and Rec. Q.767.

2.6.2 The test items to verify CLI supplementary services are identified. Details of the tests can be found in Section 2D of Annex A.

2.7 JUNCTION OR CIRCUIT TEST

2.7.1 The junction or circuit test shall confirm the speech connection between the IGS/SGS and the Requesting Licensee's Network through actual Call through test.

ANNEX A
SECTION 2A

SECTION 2A - SS7 MTP LEVEL 2 TEST SPECIFICATION - Q.781 RECOMMENDATION

1 Link State Control - expected signal units/orders

1.2 Timer T2

To check "Not Aligned" Timer T2. Timer T2 shall be in the range of 5 secs to 150 secs.

1.5 Normal alignment - correct procedure (FISU)

To check normal alignment procedure. Confirm that the link aligns and enters "In-service" state. Confirm that the timer T4 normal proving period is in the range of 7.5 secs to 9.5 secs (nominally at 8.2 secs).

1.21 Both ends set emergency

To check the emergency alignment procedure and timer T4 (Pe). Confirm that correct emergency alignment procedure is performed. T4 (Pe) shall be between 400 to 600 ms.

1.29 Deactivation during link in service

To check the deactivation of a Signalling Link from the "In Service" state. Confirm that an "In Service" link can be put to "Out of Service" state by command.

3 Transmission failure

3.5 Link in service (Break Tx path)

To test the response to a transmission failure when link is "In Service". Confirm that SIOS is returned by A when the Tx link fails.

SECTION 2A : SS7 MTP LEVEL 2 TEST SPECIFICATION – Q.781 RECOMMENDATION

TEST ITEM	Q.781 TEST ITEM	TITLE	RESULT	DATE	TESTED BY	REMARK
1	1.2	Timer T2				
2	1.5	Normal alignment - correct procedure (FISU)				
3	1.21	Both ends set emergency				
4	1.29	Deactivation during link in service				
5	3.5	Link in service (Break Tx path)				

ANNEX A

SECTION 2B

SECTION 2B - SS7 MTP LEVEL 3 TEST SPECIFICATION - Q.782 RECOMMENDATION

1 Signalling Link Management

1.1 First Signalling Link activation

To put into service a Signalling Linkset with 1 Signalling Link. Confirm that the Signalling Link becomes available after alignment.

1.2 Signalling Linkset deactivation (where applicable)

To remove from service a Signalling Linkset with 2 Signalling Links. Confirm that the Signalling Linkset becomes unavailable.

2 Signalling message handling

2.4 Load sharing within a linkset (where applicable)

2.4.1 All links available

To check the load sharing within a linkset with all the links available. Confirm that Calls with different values of SLS are shared among the various Signalling Links.

2.4.2 With one link unavailable

To check the load sharing within a linkset when one link is unavailable. Confirm that Calls with different values of SLS are shared among the remaining available Signalling Links.

3 Changeover

3.20 Changeover as a compatibility test (where applicable)

To check the changeover procedure as compatibility test. Confirm that changeover procedure is performed over the other available Signalling Link. The procedure may be activated from one side or from both sides depending on the switch.

4 Changeback

4.1 Changeback within a linkset (where applicable)

To check that the changeback procedure is correctly performed on restoration of a link in a linkset. Confirm that the changeback procedure is correctly performed and that the link can carry traffic.

12 Signalling link test

12.1 After activation of a link

To check the Signalling Link test procedure after activation of a Signalling Link. Confirm that SLTM and SLTA messages are exchanged between the two signalling points. Confirm that the link becomes available and can carry traffic.

SECTION 2B : SS7 MTP LEVEL 3 TEST SPECIFICATION – Q.782 RECOMMENDATION

TEST ITEM	Q.782 TEST ITEM	TITLE	RESULT	DATE	TESTED BY	REMARK
1	1.1	First Signalling Link activation				
2	1.2	Signalling linkset deactivation				
3	2.4.1	Load sharing within linkset - All links available				
4	2.4.2	Load sharing within linkset - With one link unavailable				
5	3.20	Changeover as a compatibility test				
6	4.1	Changeback within a linkset				
7	12.1	Signalling link test after activation of a link				

ANNEX A

SECTION 2C

SECTION 2C - SS7 ISUP BASIC CALL CONTROL TEST SPECIFICATION - Q.784

RECOMMENDATION

1. Circuit supervision

1.2 Reset of circuits

1.2.1 RSC received on an idle circuit

To verify that on receipt of a reset circuit message SP A will respond by sending a release complete message.

1.2.2 RSC sent on an idle circuit

To verify that SP A is able to generate reset-circuit message.

1.2.5 Circuit group reset received

To verify that on receipt of one circuit group reset message SP A will respond by sending a circuit group reset acknowledge message.

1.2.6 Circuit group reset sent

To verify that SP A is able to generate a circuit group reset message.

1.3 Blocking of circuits

1.3.1 Circuit group blocking/unblocking

1.3.1.1 CGB and CGU received

To verify that the circuit group blocking feature can be correctly initiated.

1.3.1.2 CGB and CGU sent

To verify that SP A is able to generate one circuit group blocking message and one circuit group unblocking message.

1.3.2 Circuit blocking/unblocking

1.3.2.1 BLO received

To verify that the blocking/unblocking procedure can be correctly initiated.

1.3.2.2 BLO sent

To verify that SP A is able to generate blocking messages.

- 1.3.2.3 Blocking from both ends; removal of blocking from one end
To verify that the blocking/unblocking procedure can be correctly initiated.
- 1.3.2.4 IAM received on a remotely blocked circuit
To verify that an IAM will unblock a remotely blocked circuit.
- 2. Normal Call Setup**
- 2.2 Called address sending
 - 2.2.1 “en bloc” operation
To verify that a Call can be successfully established (all digits included in the IAM).
 - 2.2.2 Overlap operation (with SAM)
To verify that signalling point A can initiate a Call using an IAM followed by a SAM.
- 2.3 Successful Call setup
 - 2.3.1 Ordinary Call (with various indications in ACM)
To verify that a Call can be successfully completed using various indications in address complete messages.
 - 2.3.2 Ordinary Call (with ACM, CPG and ANM)
To verify that a Call can be successfully completed using address complete message, Call progress message and answer message.
 - 2.3.3 Ordinary Call (with various indications in CON)
To verify that a Call can be successfully completed using various indications in the connect message.
 - 2.3.6 Blocking and unblocking during a Call (initiated)
To verify that the circuit blocking and unblocking procedure can be correctly initiated during a Call.
 - 2.3.7 Blocking and unblocking during a Call (received)

To verify that the circuit blocking and unblocking procedure can be correctly received during a Call.

3. Normal Call release

3.1 Calling party clears before address complete

To verify that the Calling party can successfully release a Call prior to receipt of any backward message.

3.2 Calling party clears before answer

To verify that the Calling Party can successfully release a Call prior to receipt of answer.

3.3 Calling Party clears after answer

To verify that the Calling Party can successfully release a Call after answer.

3.4 Called Party clears after answer

To verify that a Call can be successfully released in the backward direction.

3.5 Suspend initiated by the Network

To verify that the Called subscriber can successfully clear and reanswer a Call.

3.6 Suspend and resume initiated by a Calling Party

To verify that the Calling subscriber can successfully suspend and resume a Call.

3.7 Suspend and resume initiated by a Called Party

To verify that the Called subscriber can successfully suspend and resume a Call.

4. Unsuccessful Call setup

4.1 Validate a set of known causes for release

To verify that the Call will be immediately released by the outgoing signalling point if a release message with a given cause is received and the correct indication is given to the Calling Party.

4.1.1 Called subscriber busy : # 17 user busy

- 4.1.2 Destination circuits are busy : # 42 switching equipment congestion
- 4.1.3 Call rejected or not accepted due to SCR, SCA or IAB service : #21 Call rejected
- 4.1.4 Calling to an unallocated number : #1 unallocated number
- 4.1.5 All outgoing routes/trunk busy : #34
- 4.1.6 Q.118 timer; no answer from Called Party : # 19 no answer from user
- 4.1.7 Address incomplete : #28

5. Abnormal situation during a Call

5.2 Timers

5.2.2 T9 : waiting for an answer message

To verify that if an answer message is not received within T9 after receiving an address complete message the connection is released by the outgoing signalling point.

5.2.4 T6 : waiting for RES (Network) message

To verify that the Call is released at the expiration of timer T6.

5.3 Reset of circuits during a Call

5.3.1 Of an outgoing circuit

To verify that on receipt of a reset message the Call is immediately released - outgoing Call.

5.3.2 Of an incoming circuit

To verify that on receipt of a reset message, a Call is immediately released - incoming Call.

7. Bearer services

7.1 64 kb/s unrestricted

7.1.1 Successful Call setup

To verify that a 64 kb/s Call can be successfully completed using appropriate transmission medium requirement and user service information parameters.

7.1.2 Unsuccessful Call setup

To verify that the Call will be immediately released by the outgoing signalling point if a release message with a given cause is received and, for circuits equipped with echo control, the echo control device is enabled.

7.2 3.1 kHz audio

7.2.1 Successful Call setup

To verify that a 3.1 kHz audio Call can be successfully completed using appropriate transmission medium requirement and information parameters.

7.3 Speech

7.3.1 Successful Call setup

To verify that a speech Call can be successfully completed using appropriate transmission medium requirement and information parameters.

**SECTION 2C : SS7 ISUP BASIC CALL CONTROL TEST SPECIFICATION – Q.784
RECOMMENDATION**

TEST ITEM	Q.784 TEST ITEM	TITLE	RESULT	DATE	TESTED BY	REMARK
1	1.2.1	RSC received on an idle circuit				
2	1.2.2	RSC sent on an idle circuit				
3	1.2.5	Circuit group reset received				
4	1.2.6	Circuit group reset sent				
5	1.3.1.1	CGB and CGU received				
6	1.3.1.2	CGB and CGU sent				
7	1.3.2.1	BLO received				
8	1.3.2.2	BLO sent				
9	1.3.2.3	Blocking from both ends; removal of blocking from one end				
10	1.3.2.4	IAM received on a remotely blocked circuit				
11	2.2.1	"EN BLOC" operation				
12	2.2.2	Overlap sending (with SAM)				
13	2.3.1	Ordinary Call (with various indications in ACM)				

TEST ITEM	Q.784 TEST ITEM	TITLE	RESULT	DATE	TESTED BY	REMARK
14	2.3.2	Ordinary Call (with ACM, CPG and ANM)				
15	2.3.3	Ordinary Call (with various indications in CON)				
16	2.3.6	Blocking and unblocking during a Call (initiated)				
17	2.3.7	Blocking and unblocking during a Call (received)				
18	3.1	Calling Party clears before address complete				
19	3.2	Calling Party clear before answer				
20	3.3	Calling Party clear after answer				
21	3.4	Called Party clear after answer				
22	3.5	Suspend initiated by the Network				
23	3.6	Suspend and resume initiated by a Calling Party				
24	3.7	Suspend and resume initiated by a Called Party				
25	4.1.1	Called subscriber busy: #17 user busy				
26	4.1.2	Destination circuits are busy: #42 switching equipment congestion				
27	4.1.3	Call rejected or not accepted due to SCR, SCA or IAB service : #21 Call rejected				
28	4.1.4	Calling to an unallocated number: #1 unallocated number				

TEST ITEM	Q.784 TEST ITEM	TITLE	RESULT	DATE	TESTED BY	REMARK
29	4.1.5	All outgoing routes/trunks busy : #34				
30	4.1.6	Address incomplete : #28				
31	4.1.7	Q.118 timer, no answer from Called Party: #19 no answer from user				
32	5.2.2	T9: waiting for an answer message				
33	5.2.4	T6: waiting for RES (Network) message				
34	5.3.1	Of an outgoing circuit				
35	5.3.2	Of an incoming circuit				
36	7.2.1	Successful Call setup (3.1kHz audio)				
37	7.3.1	Successful Call setup (Speech)				

ANNEX A

SECTION 2D

SECTION 2D - SS7 ISUP PROTOCOL TEST SPECIFICATION FOR SUPPLEMENTARY

SERVICES - Q.785 RECOMMENDATION

3 CLI

3.1.1 CLIP - Network provided : sent

To verify that CLIP (Network provided) can be correctly sent in the Calling Party number parameter.

3.1.2 CLIP - Network provided : received

To verify that CLIP (Network provided) can be correctly received in the Calling Party number parameter.

3.2.1 CLIP - user provided : sent

To verify that CLIP (user provided) can be correctly sent in the Calling Party number parameter.

3.2.2 CLIP - user provided : received

To verify that CLIP (user provided) can be correctly received in the Calling Party number parameter.

3.3.1 CLIR - Network provided : sent

To verify that CLIR (Network provided) can be correctly sent in the Calling Party number parameter.

3.3.2 CLIR - Network provided : received

To verify that CLIR (Network provided) can be correctly received in the Calling Party number parameter.

3.4.1 CLIR - user provided : sent

To verify that CLIR (user provided) can be correctly sent in the Calling Party number parameter.

3.4.2 CLIR - user provided : received

To verify that CLIR (user provided) can be correctly received in the Calling Party number parameter.

SECTION 2D : SS7 ISUP PROTOCOL TEST SPECIFICATION FOR SUPPLEMENTARY SERVICES - Q.785 RECOMMENDATION

TEST ITEM	Q.785 TEST ITEM	TITLE	RESULT	DATE	TESTED BY	REMARK
1	3.1.1	CLIP - Network provided: sent				
2	3.1.2	CLIP - Network provided: received				
3	3.2.1	CLIP - user provided: sent				
4	3.2.2	CLIP - user provided: received				
5	3.3.1	CLIR - Network provided: sent				
6	3.3.2	CLIR - Network provided: received				
7	3.4.1	CLIR - user provided: sent				
8	3.4.2	CLIR - user provided: received				

ANNEX A

SECTION 2E

SECTION 2E - INTERCONNECT LINKS AND INTERCONNECT CONFIGURATION BETWEEN SINGTEL AND FBO

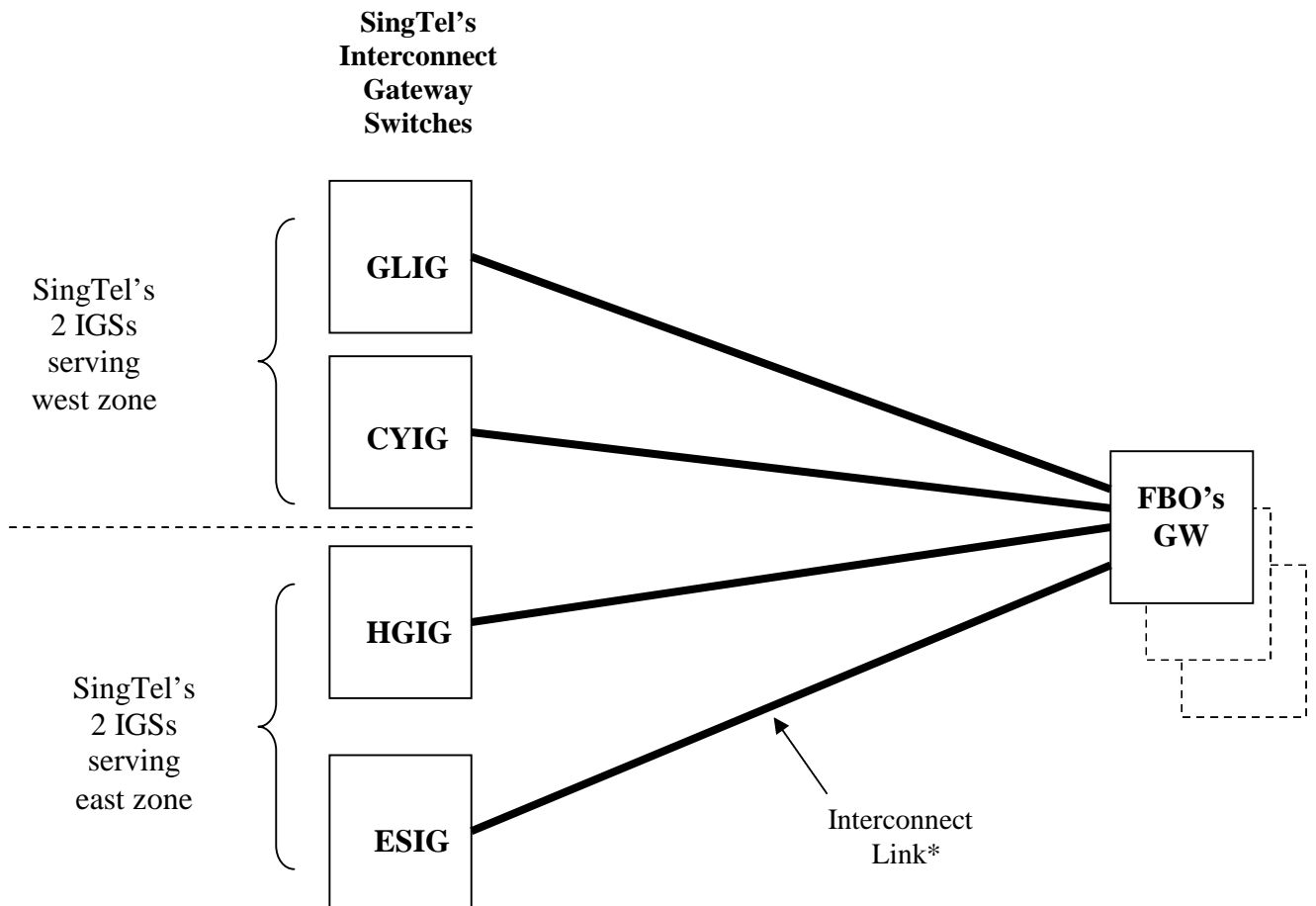

Legend:

- ESIG** – East IGS
- HGIG** - Hougang IGS
- GLIG** – Geylang IGS
- CYIG** – City IGS
- GW** – Gateway Switch

* Minimum Interconnection Capacity of 2E1s per IGS

ANNEX A

SECTION 2F

SECTION 2F - INTERCONNECT LINKS AND INTERCONNECT CONFIGURATION BETWEEN SINGTEL AND SBO

**SingTel's
SBO Gateway Switch**

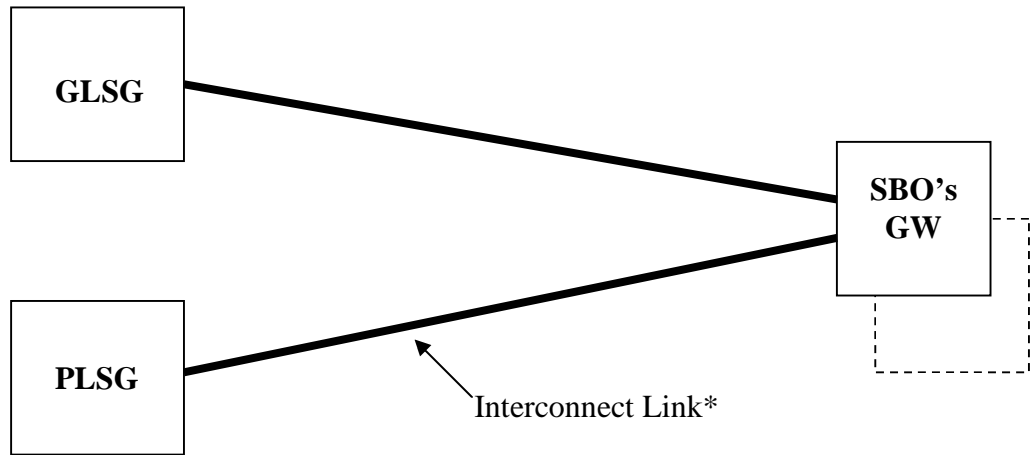

Legend:

GLSG – Geylang SGS
PLSG – Paya Lebar SGS
GW – Gateway Switch

* Minimum Interconnection Capacity of 2 E1s per SGS

ANNEX B

OPERATIONAL PROCEDURES

ANNEX B – OPERATIONAL PROCEDURES

1. INTRODUCTION

1.1 This Annex provides the operations and maintenance procedures to be carried out by the Parties to maintain satisfactory connection to each other's Network. It generally provides the fault handling procedures related to the Network. Procedures for carrying out planned engineering works, testing and monitoring are also described in this Section.

2. FAULT HANDLING PROCEDURES

2.1 General

2.1.1 Prior to activating the fault handling procedures, the Party reporting the fault (**reporting Party**) must reasonably establish that a genuine fault exists and also that every effort has been made to prove that the fault is not within the reporting Party's side of the POI.

2.1.2 Faults related to the Local Leased Circuits from SingTel are not covered in this RIO Agreement and its Annexes. The Requesting Licensee is responsible for the Local Leased Circuit. It is the Requesting Licensee's responsibility to ensure that the fault does not lie on its side of the POI, including a fault relating to the Interconnection Link before reporting the fault to SingTel under this RIO Agreement.

2.1.3 Each Party shall maintain its own fault reporting centre which shall be responsible for handling the faults between Networks, coordinating the fault clearance (including escalations) within its own Network and subsequently reporting the clearance of the fault to the other Party. Appendices 1 and 2 contain details of both Parties' fault reporting centres.

2.1.4 Both Parties shall co-operate in any investigation and follow up actions and keep each other informed on the status of the progress of the fault clearance in a timely manner.

2.1.5 Each Party shall establish twenty-four (24) hour contact points for fault reporting at its nominated fault reporting centre. Appendices 1 & 2 contain information on the contact points of the Parties for such purpose.

2.2 **Type Of Faults**

2.2.1 Faults reported may be classified as follows:

- (i) Signalling Link faults; and
- (ii) Gateway Switch Network faults.

2.2.2 **Signalling Link Faults**

2.2.2.1 All Signalling Links provided by SingTel shall be supervised closely by the Requesting Licensee and any fault shall be reported to the reporting centre of SingTel as soon as possible.

2.2.3 **Gateway Switch Network Faults**

2.2.3.1 Faults related to the IGS/SGS or Requesting Licensee's system shall be referred to the related IGS/SGS Switch during office hours, or NMC during After Office Hours.

2.3 **Interconnect Fault Status**

2.3.1 When a Party reports a fault to the other Party, they shall agree on the classification of the fault reported, i.e. whether it is service affecting or non-service affecting. They will also exercise their judgement and discretion and agree upon whether a non-service affecting fault could eventually develop into a service affecting fault.

2.3.2 Service affecting fault(s) may cause service interruption to the Customers when Interconnected Calls conveyed between the Networks encounter great difficulty in completion. Failure of more than one-third of the Interconnect Links, breakdown of major cable plant, loss of SS7 Signalling Linkset which are all likely to result in various degrees of service interruption shall be included in the classification of service affecting fault(s).

2.3.3 Non-service affecting fault(s) are those that do not adversely affect the Call handling capability of the Network to complete the Interconnected Calls. Failure of less than one-third of the Interconnect Links or the loss of SS7 Signalling Links (not affecting the Signalling Linkset) shall be included in the classification of non-service affecting fault(s) unless otherwise agreed by both Parties to upgrade it to service affecting fault(s).

2.3.4 Table 3.1 below shows the target response time for service affecting and non-service affecting fault(s).

2.4 Handling Of Faults

2.4.1 Interconnect Link faults (excluding SS7 Signalling Link faults)

- (a) Faults due to optical fibre breakdown, SDH equipment failure or other related equipment in the IGS/SGS which causes the unavailability of an Interconnect Link that does not carry an SS7 Signalling Link, shall constitute an Interconnect Link fault.
- (b) Interconnect Link faults that affect less than one-third of the working capacity of the relevant Interconnect Link shall be included in the classification of non-service affecting fault(s). Interconnect Link faults that affect one-third or more of the working capacity of the relevant Interconnect Link shall be included in the classification of service affecting fault(s).

2.4.2 Signalling Link Faults

All Signalling Links provided by the Party shall be supervised closely by the Party and any fault shall be reported to the reporting centre of the other Party as soon as possible. Signalling Link failures that do not affect the operation of the signalling Linkset shall be considered as non-service affecting. Signalling Linkset failure shall be considered as service affecting.

2.4.3 IGS/SGS Network Faults

Faults related to the IGS/SGS equipment may have an effect on the conveyance of Interconnected Calls between the Networks. If such IGS/SGS fault cannot be cleared by normal fault clearance procedures by the Party/Parties concerned, then it will be reported to the higher level following the fault escalation procedure.

3. TARGET RESPONSE TIMES

3.1 The target response time for attendance to an alarm or reported fault will depend on the time of its occurrence as contained in Table 3.1 below. "Office Hours" is defined as 8am to 5pm for Mondays to Fridays (except Public Holidays). The whole of Saturday, Sunday and any Public Holiday and the hours outside the Office Hours are referred to as "After Office Hours".

Fault Type	Response Time	
	During Office Hours	After Office Hours
Service Affecting	within one (1) hour of receipt of notification	within two (2) hours of receipt of notification
Non-Service Affecting	within two (2) hours of receipt of notification	within next Working Day of receipt of notification

Table 3.1 - Target Response Time

4. FAULT ESCALATION

4.1 Procedure

4.1.1 Where a fault persists and the Parties agree that progress of the remedy is not satisfactory, the fault may be escalated according to the fault escalation timescales and escalation reporting levels as outlined in clauses 4.2 and 4.3 herein respectively.

4.1.2 The Parties shall immediately inform the first level of escalation within the respective Party's organisation at the same time when the Party which detected the fault notifies the fault reporting point of the Party for action.

4.1.3 The Parties shall maintain the communication links at the affected site(s) and report on the progress of the restoration work.

4.2 Fault Escalation Timescales

4.2.1 The Parties shall use the following timescales as guidelines for the fault escalation process. The timescales shall be used in deciding whether the restoration of a fault is being progressed satisfactorily. If the escalation time has expired and both Parties are satisfied with the progress of the fault restoration, no immediate escalation is necessary.

Fault Type	Maximum Time For Escalation (Commencing after the Response Time)		
	First Level	Second Level	Third Level
Service Affecting	Immediate	two (2) hours	four (4) hours
Non-Service Affecting	Immediate	eight (8) hours	twenty-four (24) hours

Table 4.2 – Fault Escalation Timescales

4.3 Escalation Reporting Levels

4.3.1 All requests for escalation shall be notified through each Party's fault reporting point. The reporting levels are :

Operator \ Escalation Level	SingTel	Requesting Licensee
First	Switch Engineer	to be advised by Requesting Licensee
Second	Interconnect Operations Manager	to be advised by Requesting Licensee
Third	Operations Director	to be advised by Requesting Licensee

Table 4.3 - Escalation Reporting Levels

4.4 Persistent or Repeated Faults

4.4.1 Persistent or repeated faults or issues which cannot be resolved satisfactorily through the normal channels of the Parties shall be escalated to the Second Level to expedite the fault clearance process.

4.5 Escalation Problems

4.5.1 The Parties shall notify their respective and appropriate officers stated in Table 4.3 above for problems encountered in the implementation or execution of the fault escalation procedures.

5. MAJOR SERVICE INTERRUPTION (MSI)

5.1 General

5.1.1 Major service interruption (MSI) is defined as a fault or problem which results in the inability of the available circuits on an interconnect route and has a major impact on the service offered to either Party's Customers. MSI is therefore classified as service affecting. Examples of MSI are as follows:

- (a) An extensive lineplant failure.
- (b) A major failure of SDH system terminating at the Interconnect Links.
- (c) Total loss of the signalling and/or synchronisation of the Interconnect Links.

5.2 Procedures

5.2.1 The Party encountering an MSI shall notify the other Party through fax, phone Call or other means providing real-time communication between the Parties. This should take place within thirty (30) minutes of the MSI becoming known to the Party.

5.2.2 Direct communications links shall be established between the Parties' interconnect fault reporting centres (set up as per clause 2.1.3 above). The communication links shall facilitate the effective exchange of information and progress reports. Communication liaison officers shall be appointed to maintain and man the communication links.

5.2.3 The Party responsible for clearing the MSI shall provide to the other Party regular updates of the progress through the communication links established according to clause 5.2.2 above.

5.2.4 The Party responsible for clearing the MSI fault shall inform the other Party through the communication links within thirty (30) minutes upon clearance of the MSI fault.

6. PLANNED ENGINEERING WORKS

6.1 For any planned engineering works within the Requesting Licensee's Network, which will result in momentary outage of service of the Local Leased Circuit, SS7

Signalling Links, or Gateway Exchange, the Requesting Licensee shall inform SingTel by fax through the contact points as given in Appendices 1 & 2.

- 6.2 The details of the works to be carried out shall be recorded on an “Advice of Planned Engineering Work” form (**Advice form**). The Advice form as provided in Appendix 3 shall state the date, time and duration of such works, the impact to the conveyance of Calls between the Parties’ Network, any Network management procedures required, and any contingency measures to be taken by either Party or both Parties. The schedule and duration of the planned work proposed by the Requesting Licensee shall be agreed to by SingTel before the commencement of such works.
- 6.3 The Requesting Licensee, prior to performing the planned engineering works, shall give advance notice of at least five (5) Business Days to the other Party.
- 6.4 The preferred times and duration allowed for carrying out various planned engineering works shall be between 0100 through 0500 hrs, applicable on everyday, including public holidays.
- 6.5 The Requesting Licensee shall notify SingTel that the works have been completed by completing and faxing to SingTel the last section of the Advice form.

7. TESTING AND MONITORING

- 7.1 The Requesting Licensee shall be responsible for testing and monitoring the performance of its own Network. Testing of the Interconnection Link and Signalling Links shall be kept to a minimum and shall be avoided during the busy hour periods. No testing shall be carried out before SingTel has agreed to the conduct of such tests, including any routine tests.
- 7.2 For handling problems which can only be localised through a series of test Calls (eg difficulty in reaching certain number groups), both Parties shall agree upon the details of the testing required. Test numbers and contact points shall be exchanged to facilitate the testing.

Notification Contact Points for SingTel:-

(a) SingTel Network Management Centre (NMC) (after office hours)

Location :

Telephone :

Facsimile :

Supervisor :

(b) SingTel IGS/SGS

Location :

Telephone :

Facsimile :

Supervisor :

Notification Contact Points for Requesting Licensee

(a) Requesting Licensee's Network Management Centre (NMC) - 24 hours

Location :

Telephone :

Facsimile :

Supervisor :

(b) Name of Requesting Licensee's Network Location:

Location :

Telephone :

Facsimile :

Supervisor :

Advice of Planned Engineering Works

Subject:	<i>Title of the planned works</i>
Switch/ Location:	<i>Indicate the Switch or location of the planned work</i>
Type of planned works:	<i>Signalling Link /Interconnection Link/Exchange</i>
Outage Date:	<i>Indicate the date of the planned work</i>
Outage Time:	<i>Indicate the start time of the planned work.</i>
Service Interruption Duration:	<i>Provide an estimated duration on the service interruption</i>
Number of local leased circuit/ Signalling Links affected:	<i>Indicate the number and system ID of the local leased circuit or Signalling Links affected by the planned work</i>
Effect of planned work:	<i>Describe the effect of the planned works on Calls and in which direction</i>
Reason of planned work:	<i>Describe the reason for the planned works eg due to routine/urgent maintenance or software upgrade etc</i>
Remarks:	<i>To include additional comments or remarks eg Preparation work will commence at around “time” on “date”</i>
Issuing Officer:	<i>Indicate the name and designation of the officer issuing the advice of planned work.</i>