

# **Letter Box Specifications And Guidelines**

## **CONTENTS**

### **1. GENERAL INFORMATION ON LETTER BOXES**

- 1.1. Introduction to Letter Box Installation
- 1.2. General Information
- 1.3. Developer Responsibility
- 1.4. Multi-tenanted Premises
- 1.5. Single-tenanted Premises
- 1.6. Mixed Development
- 1.7. Postal Code
- 1.8. Unit Numbers
- 1.9. Approval Procedures
- 1.10. Submission Requirement
- 1.11. Responsibility of the Qualified Person (QP) and Role of SingPost
- 1.12. Specifications

### **2. SPECIFICATION OF LETTER BOXES**

- 2.1. Dimensions
- 2.2. Aperture
- 2.3. Horizontal Ledge
- 2.4. Aperture Cover
- 2.5. Lockable Door
- 2.6. Identification
- 2.7. Numbering Sequence
- 2.8. Height of Letter Box Nest
- 2.9. Layout of Letter Box Nest
- 2.10. Location of the Letter Boxes (nest and standalone)
- 2.11. Number of Nest Per Block (i.e. per Postal Code)
- 2.12. Spare Letter Boxes

2.13. Weather Shelter

**3. MASTERDOOR LETTER BOXES**

3.1. Types of Masterdoor Letter Boxes

3.2. Aperture

3.3. Ledge

3.4. Internal Numbering

3.5. Range of Unit Numbers

3.6. "For Returned Mail Only"

3.7. Size of the Masterdoor and Opening

3.8. Pigeonhole Masterdoor Keys, Aperture Master Keys and Aperture Masterdoor Keys

3.9. Masterdoor Handle

**4. MAIL STORAGE ROOM/ COMPARTMENT**

**5. OUTDOOR LETTER BOXES FOR SINGLE PREMISES**

**6. ENHANCED SECURITY**

**7. OTHER LETTER BOXES DESIGNS**

## **1. GENERAL INFORMATION ON LETTER BOXES**

### **1.1. Introduction to Letter Box Installation**

In accordance with section 16(3) of the Postal Services Act (Cap. 237A) ("the Act"), a developer of a residential, commercial or industrial building shall:

- a) Provide one letter box for each lot within any residential building, and one letter box for the occupier of each lot in the case of any commercial or industrial building;
- b) Ensure that the letter boxes in (a) are numbered in numerical sequence; and
- c) Comply with all other specifications issued, approved or amended by the Information Communications Media Development Authority (the "Authority") under section 16(1) of the Act relating to the number, place, dimensions and other characteristics of letter boxes.

The Act provides that the Authority shall be the Postal Authority responsible for the administration of the Act. The Authority has approved the specifications and guidelines set out herein for the purposes of section 16(1) of the Act. Singapore Post Ltd ("SingPost"), as the designated Public Postal Licensee, has been authorised by the Authority to administer such specifications and guidelines for the purpose of ensuring conformity in the design and installation of letter boxes in Singapore. Developers of residential, commercial and industrial properties are required to submit details of its letter box designs and installation plans in compliance with such specifications and guidelines to:

The Officer-in-charge  
Singapore Post Limited  
Mail Operations & Service Quality Department  
10 Eunos Road 8  
#05-37  
Singapore Post Centre  
Singapore 408600  
Telephone: 6845 6698 / 6845 6521  
Facsimile: 6841 3843

### **1.2. General Information**

Space provision for erecting letter boxes is to be taken into consideration during planning stages when computing the plot ratio of built-up area. This is to avoid the letter boxes from being sited at undesirable location due to constraint in meeting the plot ratio requirement.

### **1.3. Developer Responsibility**

Developers of high-rise and low-rise buildings are required by law to provide sufficient letter boxes for the delivery of mail to the occupants. The letter boxes are to be installed before the occupants move into the building. One letter box is to be provided for each official address approved by Property Tax Department, Inland Revenue Authority of Singapore ("IRAS").

Where letter boxes have not been provided for by the developer or are not commissioned on or before date of TOP and there are already mail items for the occupants of the building, Postal Service Operators may treat such mail items as undelivered and treat such mail as required under Section 16 of the Postal Services Regulations 2008. However, if the developer, owner, managing agent or town council is willing to undertake delivery to the recipients, Postal Service Operators may hand the mail items to the developer, owner, managing agent or town council for delivery to the recipients.

The Postal Service Operators licensed by by the Authority, including the designated Public Postal Licensee, SingPost, shall not be responsible for the repair and maintenance of the letter boxes (including the common masterdoor, if applicable). The Postal Service Operators only use the letter boxes for the purpose of mail delivery to the occupants of the building. However, if it is established that the damage to the letter box is due to the Postman's negligence or carelessness, the relevant Postal Service Operator shall repair the letter box.

#### 1.4. Multi-tenanted Premise

Multi-tenanted premise refers to a building with a block number and multiple unit numbers officially approved by IRAS. A nest of letter boxes is to be centrally located on the first storey of the building or at an approved location that is not obstructed and easily accessible by the Postman on bicycle, scooter or van. The area around the nest of letter boxes should be adequately ventilated with sufficient lighting to enable the Postman to read the address on the mail items and the unit number on the letter boxes. The letter boxes should be sheltered from the weather and sited away from sources of obnoxious smell (e.g. rubbish collection point) by awning or similar structure.

#### 1.5. Single-tenanted Premise

Single-tenanted premise consists of only one official IRAS approved house or block number. This can be a factory, bungalow, semi-detached or terrace house. The letter box is to be located at the main gate so that the Postman can deliver the mail into the letter box without having to enter the building compound. Alternatively, it can be located at the building proper provided the Postman can easily reach the letter box on his bicycle, scooter or van.

#### 1.6. Mixed Development

Mixed development refers to a development comprising both multi-tenanted premises (apartment blocks, condominium, tower offices) and single-tenanted premises (terrace houses, terrace factory) that are being developed on the same plot of land. The requirement for the letter boxes in a mixed development shall follow that of either a multi-tenanted premises (a nest of letter boxes for each block/tower) or single-tenanted premises (a letter box for each terrace house/factory) – according to the physical features of the premises (i.e. block, terrace house).

#### 1.7. Postal Code

The 6-digits Postal Code is a very critical component in the address group. It enables mail to be sorted and sequenced automatically by the mail processing machines thereby minimising manual interventions. Therefore it is very essential to ensure that each block or house number is assigned a unique 6-digit postal code. Where there are several blocks in a multi-tenanted premises, each block should have its own

block number (and hence a unique postal code). The nest of letter boxes for each block (with a unique Postal Code) is to be centrally located at the block. IRAS will allocate the Postal Code for the development from the list, which SingPost have provided, to IRAS.

#### 1.8. Unit Numbers

The unit numbers within a multi-tenanted premise shall not be repeated. This can assist in the delivery of mail items where the block number has been wrongly written or inadvertently omitted by the sender.

For single-tenanted premises, “ # ” sign should not be used for the house numbering.

#### 1.9. Approval Procedures

The two stages of the approval procedures are:

##### Stage 1

Submission of the design for endorsement prior to installation.

Possible outcomes:

- a) Submission is endorsed without any amendment. Installation may proceed.
- b) Submission is endorsed but with some minor amendments. Installation may proceed subject to the compliance with the minor amendments.
- c) Submission is not endorsed as there is major non-compliance. Discussion may be required.

##### Stage 2

Upon completion of the installation, the developer will have to arrange for an inspection. SingPost will issue a Letter of Compliance upon satisfactory inspection of the installation. Mail delivery will not commence until the Letter of Compliance has been issued.

It is strongly recommended that the developer arranges for pre-submission discussion with SingPost. This can minimise time and effort involved in resubmission.

#### 1.10. Submission Requirement

The following documents, endorsed by the developer, owner, managing agent or town council, are required and must be submitted by the Qualified Person (“QP”) (e.g. the architect or engineer) in charge of the development:

- a) Copy of the IRAS letter (except HDB public housing projects) showing the official block/house number, unit numbers and postal code.
- b) Two sets of the Site Plan.
- c) Two sets of the drawing showing the proposed location of the letter boxes.
- d) Two sets of the shop drawings of the letter boxes.

Alternatively, the contractor appointed by the QP, the developer, owner, managing agent or town council (“appointed contractor”) can submit the documents on behalf of the QP provided that:

- a) SingPost has been informed in writing the name of the appointed contractor;  
or
- b) a letter of authorisation duly signed by the QP, the developer, owner, managing agent or town council vis-à-vis the appointed contractor has been provided to SingPost.

#### 1.11. Responsibility of the Qualified Person (QP) and Role of SingPost

It is the responsibility of the QP in charge of the development to ensure that the location of the letter boxes meets all the requirement of the relevant authorities (e.g. Fire Services Bureau). It is also his responsibility to ensure the structural integrity of the letter boxes.

The role of SingPost is to ensure that the developer meets the specifications so that letter boxes are user-friendly and that mail items delivered to the occupants are in their original conditions i.e. not damaged, unnecessarily folded or wet.

#### 1.12. Specification

Section 2 below sets out the specification for the different designs that can be adopted by the developer. The letter box can be made of any durable material such as ionized aluminium, stainless steel.

## 2. SPECIFICATION OF LETTER BOXES

### 2.1. Dimensions

The minimum internal dimensions of a letter box are:

- (a) Residential Premises
  - Letter Box Nest  
110mm (H) x 270mm (W) x 380mm (D)
  - Gate Pillar or Standalone Letter Boxes  
380mm (H) x 270mm (W) x 150mm (D)
- (b) Business Premises
  - Letter Box Nest  
150mm (H) x 270 mm (W) x 380 mm (D)
  - Gate Pillar or Standalone Letter Boxes  
380mm (H) x 270mm (W) x 150mm (D)

The Postman and the occupant must be able to deliver and retrieve the mail items to and from the letter box for any items that do not exceed the above dimensions, without folding or bending the mail items. The dimensions of the letter box can be larger if more mail items are anticipated.

## 2.2. Aperture

The minimum size of the aperture to enable an A4 size envelope to be inserted shall be 25 mm by 230 mm (Annex 1). The size can be larger. However, a larger aperture may facilitate unauthorised retrieval of the mail items.

The aperture should be positioned nearer the top of the letter box so that any accumulated mail inside (for whatever reasons) will not obstruct the delivery of more mail items.

## 2.3. Horizontal Ledge

A horizontal ledge of at least 25 mm is recommended to prevent unauthorized retrieval of the mail items (Annex 1).

## 2.4. Aperture Cover

An aperture cover is required for all the letter boxes. The aperture cover, especially for outdoor letter boxes, can prevent insects from building nests inside the letter box and rainwater from entering the letter box.

## 2.5. Lockable Door

Each letter box must have a lockable door.

## 2.6. Identification

The house number or unit number must be displayed on the letter box. The minimum height of the number shall be at least 12 mm to be legible at a standing position (Annex 1). In addition to the height, there should be adequate contrast between the digits and the background (by using different colours) to enhance legibility.

The number must be inscribed or riveted on the door. The QP may choose to use adhesive if the QP demonstrates this to be equally effective, and that the numbers will not easily fall off over time or easily be removed by vandals.

The unit number must also be displayed internally where the nests are installed with masterdoors. The number is to be displayed at the bottom of the "tray" (Annex 2). The height of the "tray" should not affect the dimensions stipulated in 2.1 above.

For a nest of letter boxes the block number, street name and postal code must be displayed in FULL at the top of the nest, e.g. Blk 120 Simei St 1 Singapore 520120 (Annex 3).

## 2.7. Numbering Sequence

For a nest of letter boxes, the unit numbers must be non-repeating and arranged in ascending sequential order from the Postman's view – i.e. from top to bottom and left to right (Annex 4).

Where the Postman sorts by the rear, the user/resident's view of the unit numbers shall also be in ascending sequential order from top to bottom BUT right to left – "mirror" image (Annex 5).



## 2.8. Height of Letter Box (Annex 6)

The maximum and minimum heights are to ensure that both the users and Postman can easily retrieve from and sort into the letter boxes the mail items respectively.

The maximum height must not exceed 1650 mm from the ground or finished floor level to the top of the aperture cover of the top row letter boxes (nest) or single letter box (gate pillar or standalone).

The minimum height of the plinth/base of the nest must be at least 500 mm from the ground or finished floor level. However, it can be more than 500mm if the maximum height of 1650mm has not been exceeded. This is to provide more comfort to the occupants whose letter boxes are at the bottom row of the nest.

Note: In the planning for the letter boxes, due consideration must be given to the actual thickness of the selected finishes failing which the height of the plinth/base may eventually be less than 500 mm from the finished floor level.

## 2.9. Layout of the Letter Box Nest (Annex 7)

The layout of the nest can be flexible so long as the retrieval of mail by the user and the sorting of the mail by the Postman are not hindered.

The layout can be arranged in 'L', 'U' or any configuration with sufficient working space for at least 2 persons retrieving or sorting mail at the nest. For the above configuration, there should be a space between adjacent nests to facilitate retrieval by the occupants (see Annex 7).

Where the letter boxes face each other, the minimum distance between the 2 nests must be at least 1500 mm.

## 2.10. Location of the Letter Box (nest and standalone)

A nest of letter boxes should be located centrally, not obstructed, and easily accessible by the Postman on bicycle, scooter and van. It should be away from any obnoxious source of smell (e.g. rubbish point). It should be well ventilated and lighted, and sheltered from rain by awning or similar structure.

For standalone letter box, it should be located at the main gate so that the Postman can deliver the mail into the letter box without having to enter the compound.

## 2.11. Number of Nest per Block (i.e. per Postal Code)

Every block or house is allotted a block or house number by IRAS. Each block or house number is then assigned a unique Postal Code. There must be only one nest per Postal Code in the case of multi-tenanted premises. However, 2 nests are allowed per Postal Code provided that each nest has at least 50 letter boxes. The rationale for this requirement is to allow the Postman to be more efficient in sorting and delivering the mail into the letter boxes.

## 2.12. Spare Letter Boxes

Provision of spare letter boxes for future use is encouraged to accommodate letter boxes for future new units. The numbering sequence must however be in accordance

with 2.7. Where a spare letter box is available, it may be assigned as a "For Returned Mail Only" letter box (please see 3.6 below).

All spare letter boxes must be locked internally when not used. Subsequent use of the spare letter boxes must be in accordance with the allotment of official unit numbers by IRAS. It is strongly recommended that the spare letter boxes be located at the top of the nest before the first letter box. This is to pre-empt the need to re-arrange the numbering sequence in the event additional units are added to the block (e.g. units are created within the void deck of a HDB block).

The additional letter boxes, when included subsequently in the nest, must follow the ascending sequential order of the nest. This may involve re-arranging the existing letter boxes to accommodate the new letter boxes.

#### 2.13. Weather Shelter (Annex 8)

Where the nest of letter boxes is located at the perimeter of the development, a weather shelter is required to shelter the user and Postman. The shelter will also protect the mail from getting wet while being sorted or already sorted into the letter boxes when the masterdoor, if any, is opened.

### 3. MASTERDOOR LETTER BOXES

The benefit of having masterdoors is that larger mail items can be delivered into the letter boxes so that the users need not collect them from the Postal Branches.

Masterdoors are not compulsory if there is no anti-junk mail feature which allows users to lock their apertures, but are strongly recommended.

Where new, upgraded or replacement letter boxes incorporate an anti-junk mail feature, such letter boxes shall adopt the 3-way front opening or 3-way front/back opening design.

#### 3.1. Types of Masterdoor Letter Boxes

There are currently 3 types of masterdoor letter boxes. They are:

##### (a) 2-way front opening (Annex 9)

The nest abuts against a wall and both the user and the Postman access the letter box by the front via the individual letter box door and masterdoor respectively. The masterdoor opens to reveal pigeonholes (Pigeonhole Masterdoor).

##### (b) 3-way front opening with central unlocking mechanism

The nest also abuts against a wall. The access by the user and Postman is the same as that for 2-way front opening. However, there is a central unlocking mechanism to unlock the anti-junk mail device (of every letter box in the nest) (Aperture Masterkey). This allows the developer, owner, managing agent or town council to release the individual apertures to deliver notices, newsletter etc without compromising the security and integrity of the mail.

(c) 3-way front/back opening (Annex 10)

The nest stands alone and access from the front and back is possible. The user accesses from the front via his individual letter box. The Postman, developer, owner, managing agent or town council access via the back. The developer, owner, managing agent or town council uses the masterdoor (Door A) which, when opened, exposes only the apertures of the letter boxes (Aperture Masterdoor). The Postman uses another masterdoor (Door B), which exposes the pigeonholes (Pigeonhole Masterdoor).

Note: Both the 3-way front opening and 3-way front/back opening letter boxes allow the developer, owner, managing agent or town council to use the Aperture Masterkey and Aperture Masterdoor Key to deliver internal notices, in-house newsletter etc to the occupants without compromising the security and integrity of the mail.

A common Pigeonhole Masterdoor Key shall be provided for all or a cluster of nests of letter boxes within the development or estate.

3.2. Aperture

An aperture is still required notwithstanding the Postman delivering the mail via the masterdoor.

3.3. Ledge

A ledge of 25 mm is recommended at the bottom of each letter box (from the Postman's view) to prevent mail items from falling off when the Pigeonhole Masterdoor is opened.

3.4. Internal Numbering

In addition to the external numbering, internal numbering is also required for letter boxes. (The positions of the internal numberings are shown in Annex 2). The internal unit numbers should be inscribed or riveted on the individual letter boxes so that they cannot be removed or dropped off easily which will disrupt the sorting of mail. The QP may choose to use adhesive if the QP demonstrates this to be equally effective.

3.5. Range of Unit Numbers

The range of unit numbers shall be inscribed on the top of letter boxes to identify the unit numbers contained within each panel of the masterdoor (Annex 3).

3.6. "For Returned Mail Only"

A "For Returned Mail Only" letter box should be provided. This will facilitate the return of mail to SingPost for whatever reasons. This letter box should be positioned at the last letter box in the nest whenever possible.

The text "For Returned Mail Only" is to be of a different colour from the unit numbers to draw the attention of the users.

It is preferred that the "For Returned Mail Only" letter box is installed without a lockset as the Postman accesses it via the masterdoor. However, if a lockset is provided, it shall have the same key as the masterdoor.

### 3.7. Size of the Masterdoor and Opening (Annex 11)

The size of the masterdoor shall not exceed 3 columns of the letter boxes to prevent sagging of the door due to excessive weight. The door hinges must be of durable quality and robustly constructed. Due consideration should also be given to its design so that the developer, owner, managing agent or town council can easily replace or repair a damaged masterdoor.

The masterdoors must open symmetrically.

### 3.8. Pigeonhole Masterdoor Keys

To ensure the security and integrity of the mail, only the designated Public Postal Licensee, SingPost, is allowed to have access to the Pigeonhole Masterdoor Keys. It is recommended that all Pigeonhole Masterdoor Keys be handed to SingPost upon completion of the letter box installation. If the developer, owner, managing agent or town council wishes to retain duplicates of the keys, the developer, owner, managing agent or town council should inform SingPost in writing. Under such circumstances, SingPost should be absolved of any liability should there be mail violation which arises from no fault of SingPost. The developer, owner, managing agent or town council is strongly advised not to give the Pigeonhole Masterdoor Keys to a third party other than SingPost, as it may compromise mail security and integrity.

The developer, owner, managing agent or town council is however encouraged to allow other Postal Service Operators licensed by the Authority access to the Aperture Masterkeys or Aperture Masterdoor Keys, so as to facilitate their mail delivery.

### 3.9. Masterdoor Handle

A door handle, preferably concealed type, shall be provided to assist the Postman in opening the masterdoor.

## 4. MAIL STORAGE ROOM / COMPARTMENT (Annex 12)

A mail storage room or compartment provides transit storage of mail. With this facility, occupants can expect to receive their mail earlier. Excess mail which the Scooter Postman cannot carry (on his scooter) will be transported to the mail storage room/compartment by the Van Postman. The Scooter Postman will then pick up his mail from the storage room/compartment and continue with his delivery route without having to return to his Delivery Base.

The preferred type is the storage room with a minimum area of 1000mm by 1000mm. However, if due to site constraint a storage room is not feasible, a storage compartment installed next to the nest can also meet the purpose as this has a large capacity and blends well with the nest (Drawing A).

The mail storage compartment can also be provided below the nest although this is the least preferred due to limited storage capacity (Drawing B).

The provision of the mail storage room/compartment is optional but strongly recommended. The developer should consider favourably as there are benefits.

## **5. OUTDOOR LETTER BOXES FOR SINGLE PREMISES (Annex 13)**

The outdoor letter box has to be accessible to the Postman without entering the premises. It may be built into the gate pillar or as a standalone letter box.

The dimensions of the gate pillar and standalone letter boxes are 380mm (H) x 270mm (W) x 150mm (D). The occupant must be able to retrieve any mail item not exceeding the stated dimensions without folding or bending the mail items. The letter box may be larger than the stated dimensions. However, care must be taken in its design to ensure that mail cannot be retrieved from the outside.

The minimum size of the aperture to enable an A4 size envelope to be inserted without folding should be 25 mm by 230 mm (Annex 1). It should be positioned nearer the top of the letter box so that any accumulated mail items inside will not hinder the delivery of more mail items. In addition an aperture cover shall be provided to prevent insects from building nest inside the letter box or rainwater from entering the letter box.

The maximum height of 1650 mm from the ground level as specified in paragraph 2.8 must be strictly adhered to. This is to ensure that the aperture is within easy reach of the Postman. In this regard due consideration must be given to the terrain as the letter boxes at the low end of the road may end up higher than 1650 mm.

## **6. ENHANCED SECURITY**

With enhanced security at many premises, it will be ideal if the Postman can sort the mail into the letter boxes without having to enter the secured areas. The letter boxes nest can be installed along the boundary or wall structure.

## **7. OTHER LETTER BOX DESIGNS**

Developers can write to SingPost for consideration of other letter box designs that may meet the basic specifications.

Note: All drawings in the Annexes are not drawn to scale.

### Dimensions of a Letter Box

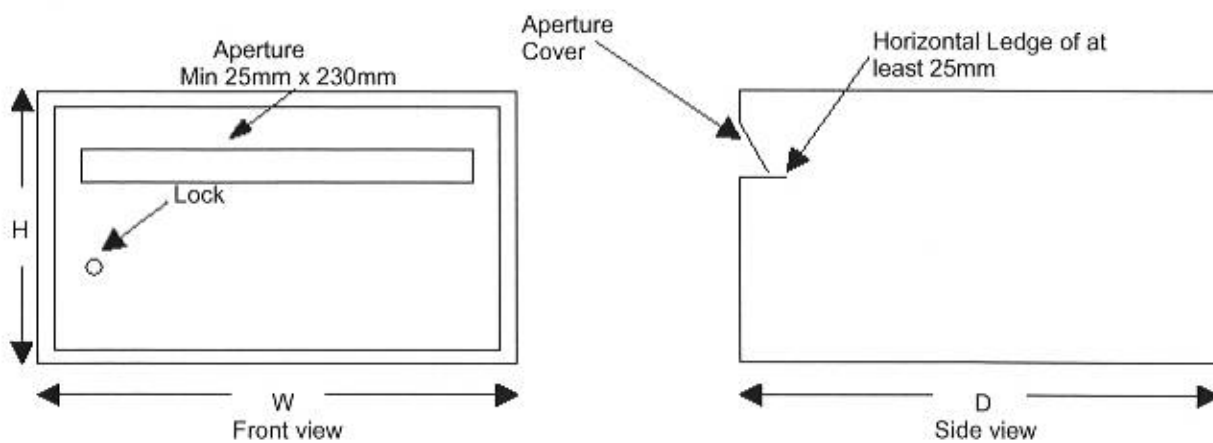

The dimensions can be larger if more mail is anticipated.

Each letter box has to display the house/unit number assigned by Property Tax Department

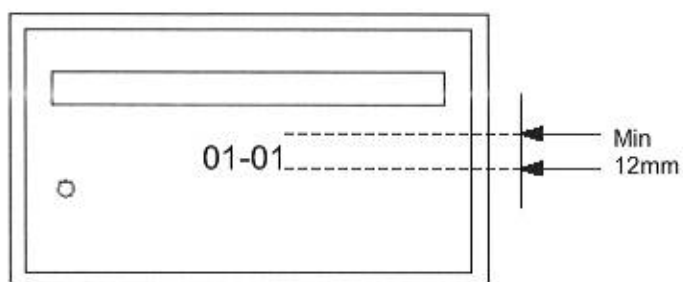

Size of unit number

## Display of Unit Numbers

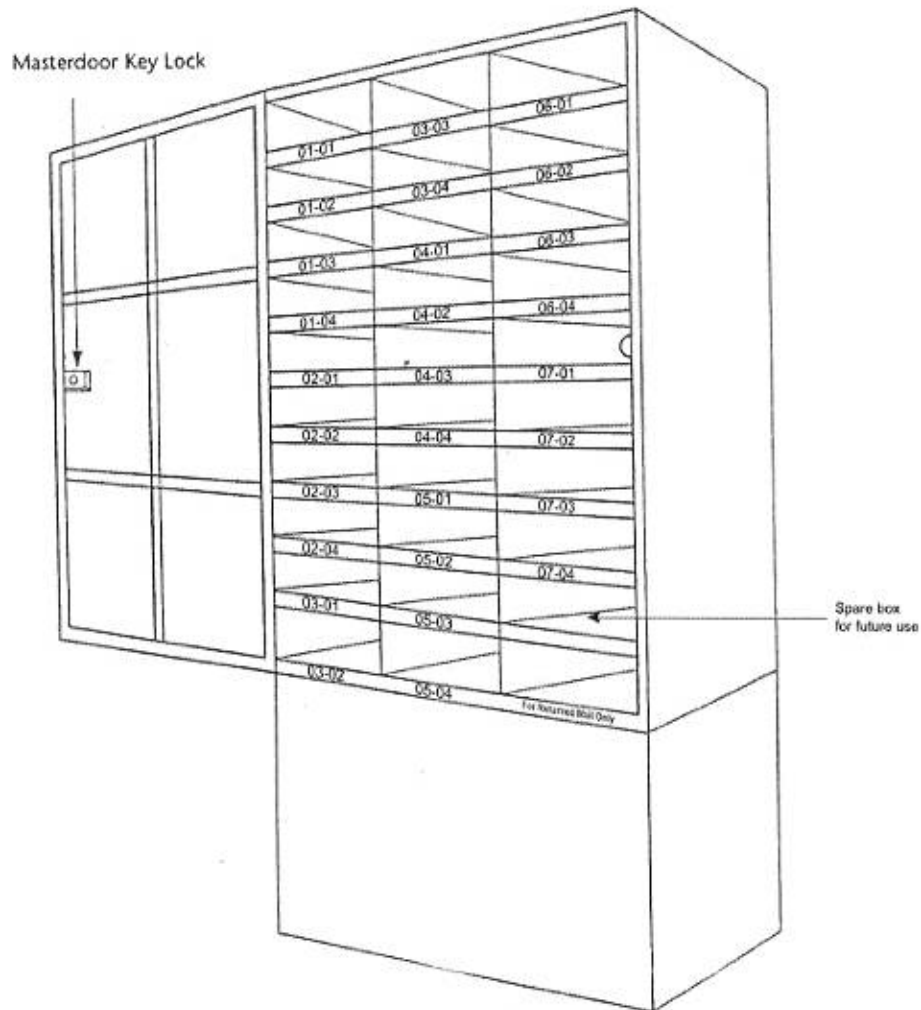

### Display of Block Address

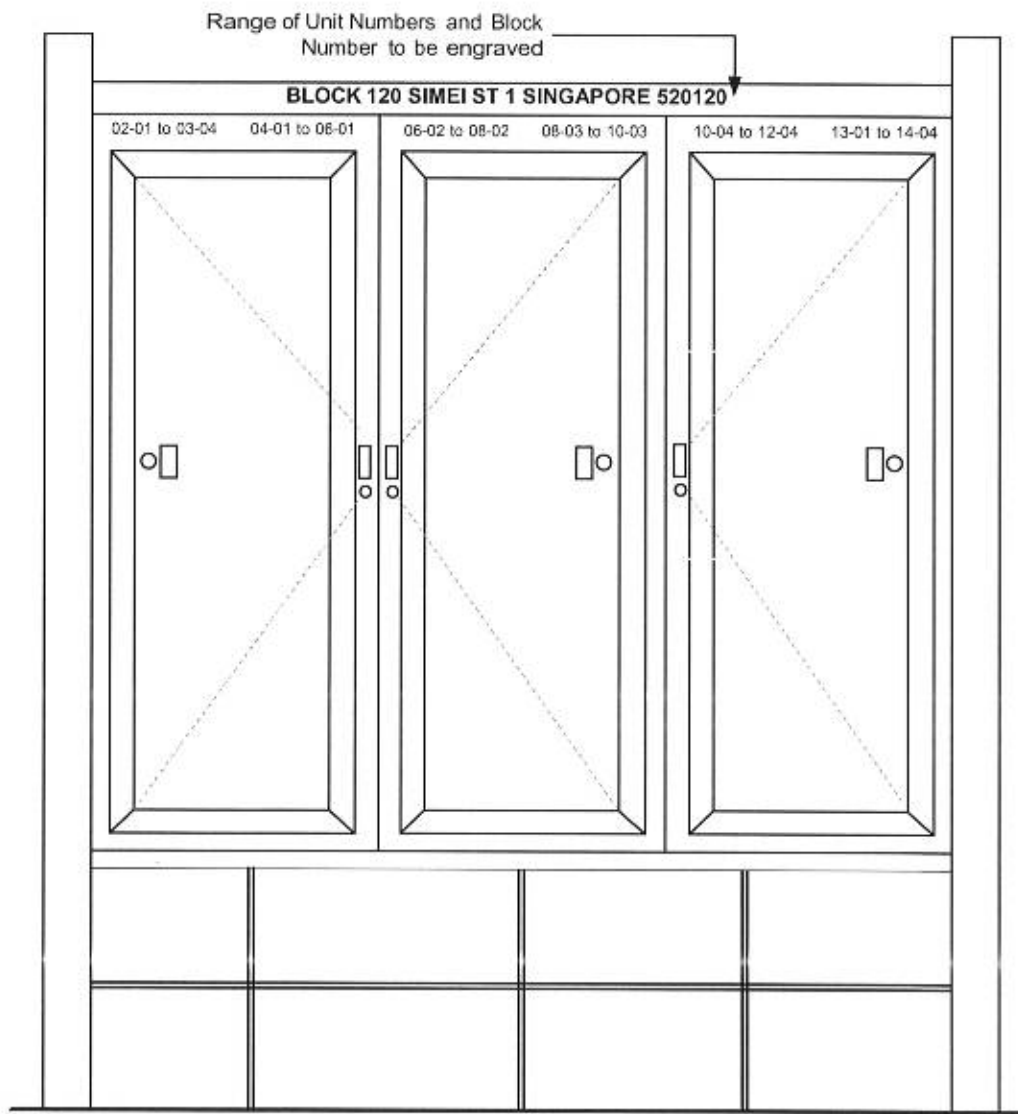

REAR VIEW WITH DOORS CLOSED



### Numbering Sequence for Front Sorting Letter Box

The unit numbers for different buildings within an estate should be non-repeating and arranged in proper running order. For nest of letter boxes, they are to be numbered in ascending sequential order (from Postman's view)

- from top-to-bottom, and
- from left-to-right as follows :

#### *Front Sorting Nest of Letter Box*

01-01	02-03	04-01	05-03	07-01
01-02	02-04	04-02	05-04	07-02
01-03	03-01	04-03	06-01	07-03
01-04	03-02	04-04	06-02	07-04
02-01	03-03	05-01	06-03	←
02-02	03-04	05-02	06-04	For Returned Mail Only

Spare box  
for future use

FRONT (POSTMAN'S) VIEW

01-01	02-03	04-01	05-03	07-01
01-02	02-04	04-02	05-04	07-02
01-03	03-01	04-03	06-01	07-03
01-04	03-02	04-04	06-02	07-04
02-01	03-03	05-01	06-03	←
02-02	03-04	05-02	06-04	For Returned Mail Only

Spare box  
for future use

FRONT (USER'S) VIEW

### Numbering Sequence for Rear Sorting Letter Box

Unit numbers within an estate should be in running order and non-repeating. For nest letter boxes with sortation of mail by postman from rear masterdoor, the letter boxes are to be numbered in sequential order at the rear of the letter boxes (from Postman's view) as follows:-

01-01	02-03	04-01	05-03	07-01	
01-02	02-04	04-02	05-04	07-02	
01-03	03-01	04-03	06-01	07-03	
01-04	03-02	04-04	06-02	07-04	
02-01	03-03	05-01	06-03		← Spare box for future use
02-02	03-04	05-02	06-04	For Returned Mail Only	

REAR (POSTMAN'S) VIEW

The numbering of the letter box door as seen by the tenant will be as follows:-

	07-01	05-03	04-01	02-03	01-01	
	07-02	05-04	04-02	02-04	01-02	
	07-03	06-01	04-03	03-01	01-03	
	07-04	06-02	04-04	03-02	01-04	
Spare box for future use →		06-03	05-01	03-03	02-01	
	For Returned Mail Only	06-04	05-02	03-03	02-02	

FRONT (USER'S) VIEW

### Height of Letter Box Nest

The minimum and maximum heights are to ensure letter boxes are located within an ergonomic height for the benefits of both users and postmen.

The maximum height must not exceed 1650 mm from the ground or finished floor level to the top of the aperture cover of the top row letter boxes (nest) or single letter box (gate pillar or standalone).

The minimum height of the plinth/base of the nest must be at least 500mm from the ground or finished floor level. However, it can be more than 500mm if the maximum height of 1650mm has not been exceeded. This is to provide more comfort to the occupants whose letter boxes are at the bottom row of the nest.

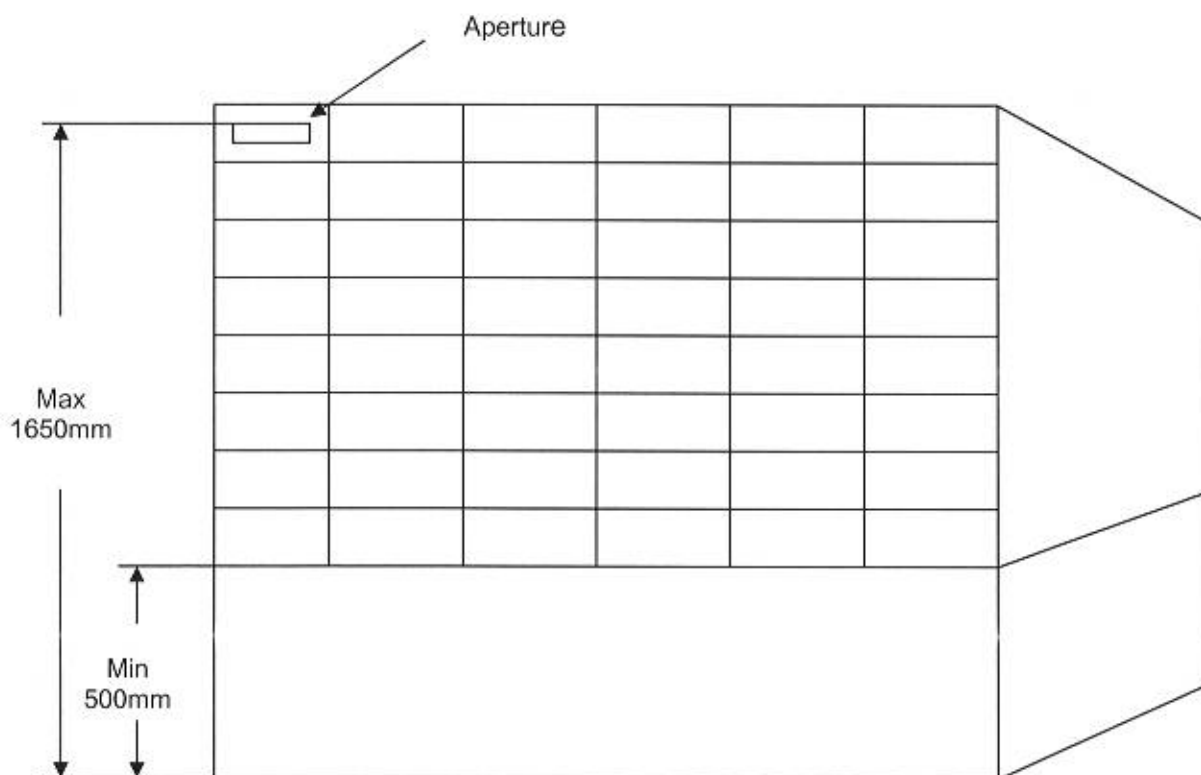

### Layout of Letter box Nest

The layout of letter box nest is flexible so long as all the letter boxes for the units in the building are centrally located.

The letter box nest may be arranged in " L ", " U " or other formations with sufficient space for at least two persons to retrieve mail from the letter boxes. For the above configuration, there should be a space between adjacent nests to facilitate retrieval by the occupants.

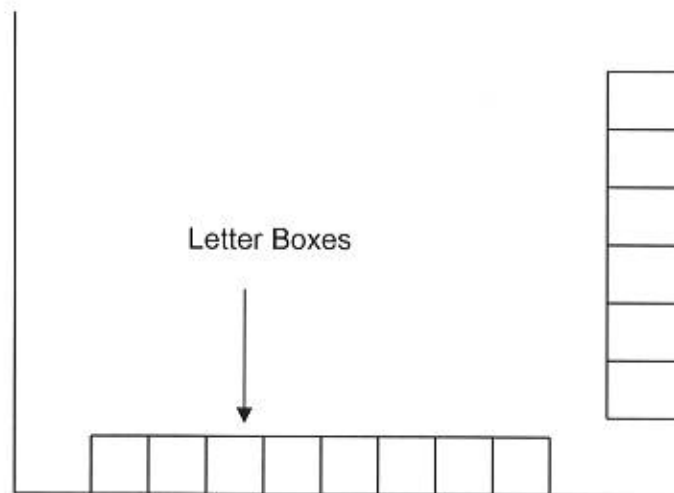

" L " Shape

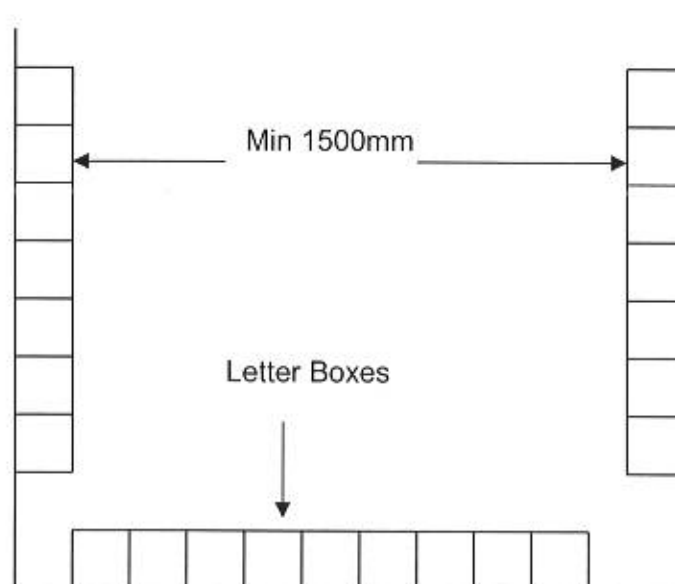

" U " Shape

Note : All dimensions indicated in the drawing are not to scale.

## Weather Shelter

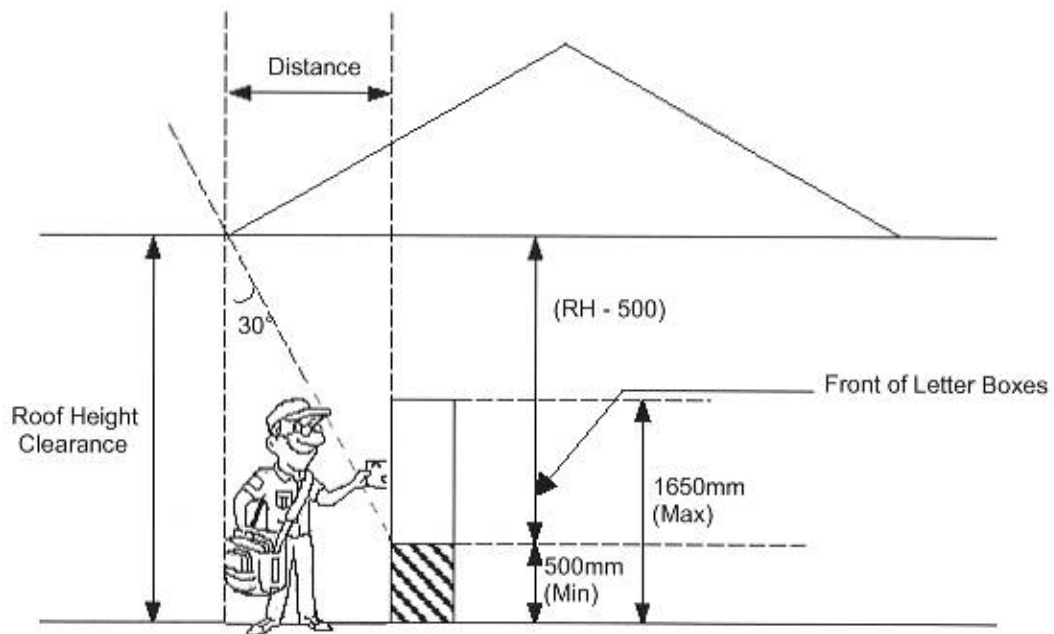

### WEATHER SHELTER

Distance =  $\tan 30^\circ \times (RH - 500)$ , and Min. Distance = 1200mm

## 2-Way Front Opening Letter Box

Annex 9

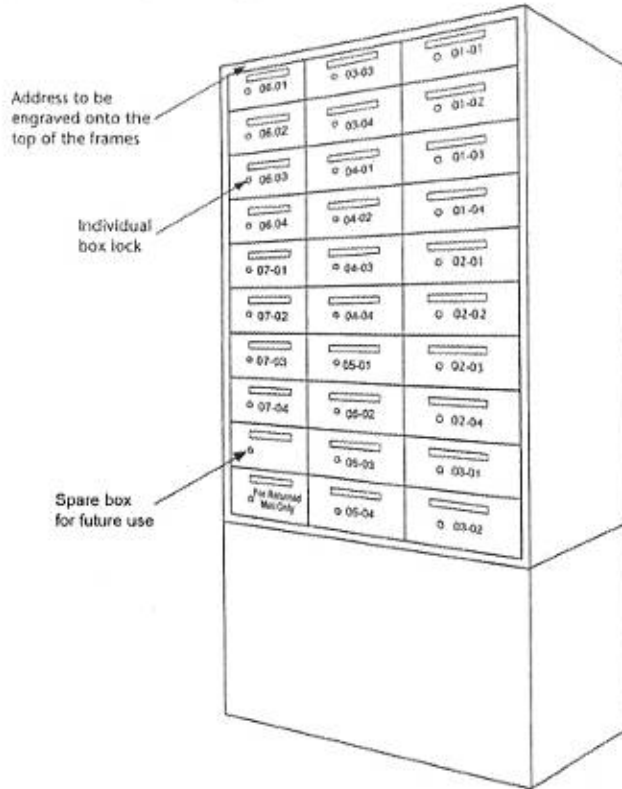

FRONT (USER'S) VIEW

NOTE : The numbering sequence is the "mirror" image of postman.

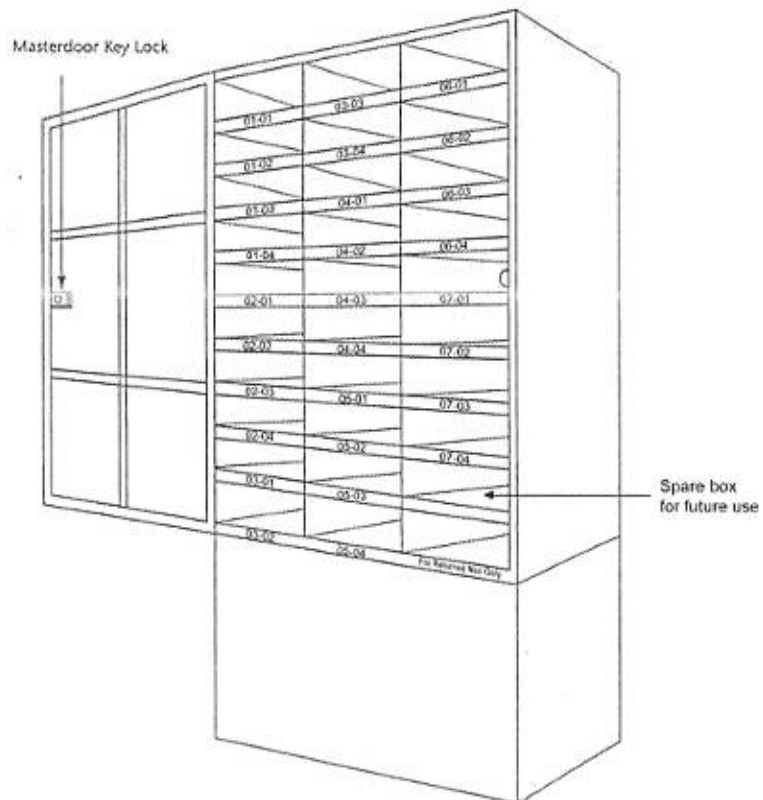

REAR (POSTMAN'S) VIEW

NOTE: The ascending numbering sequence is from top-to-bottom and from left-to-right order.

### 3-Way Front/Back Opening Letter Box

#### Rear Sorting Model

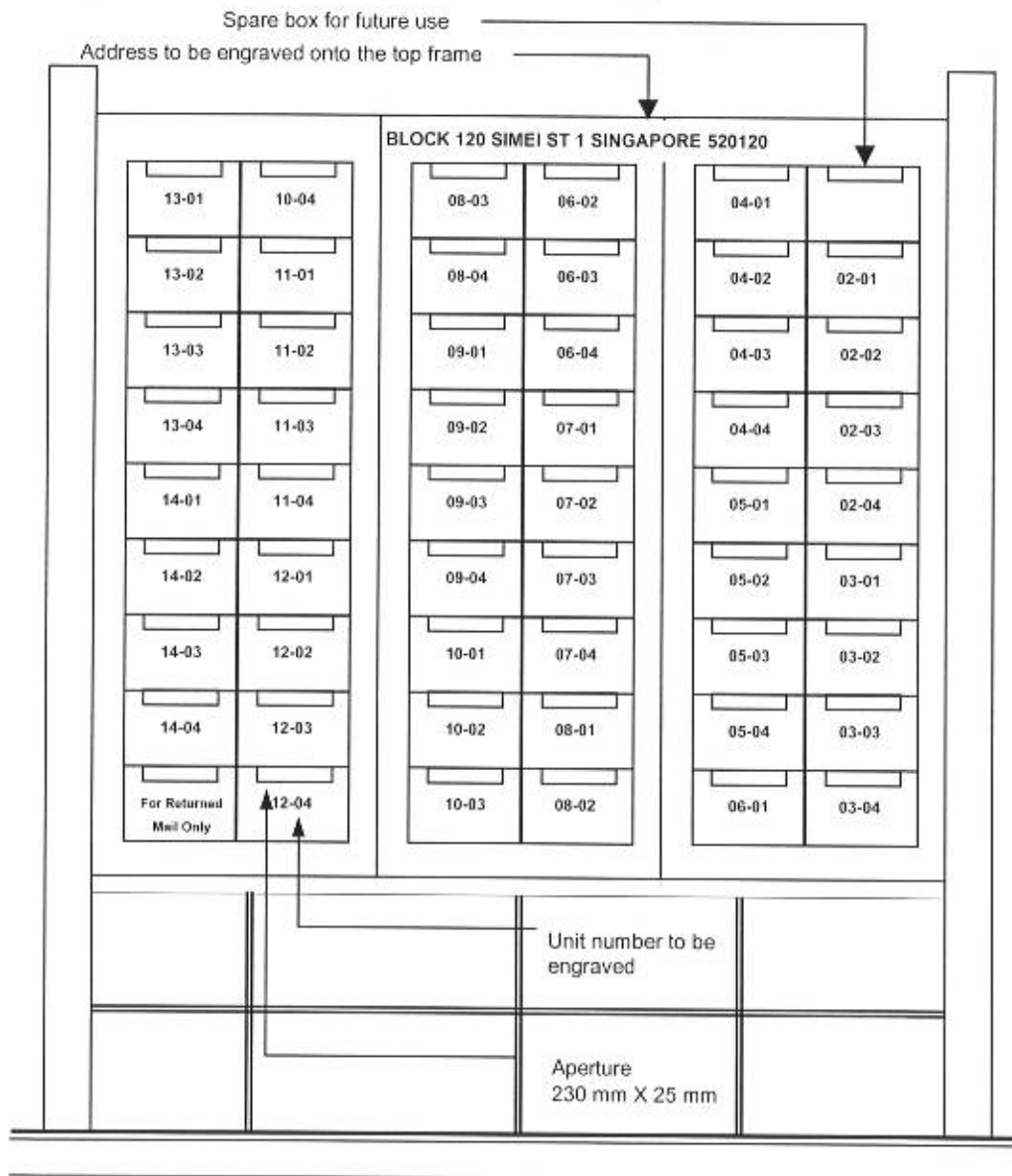

#### FRONT (USER'S) VIEW

NOTE : The numbering sequence is the "mirror" image of postmen

### 3-Way Front/Back Opening Letter Box

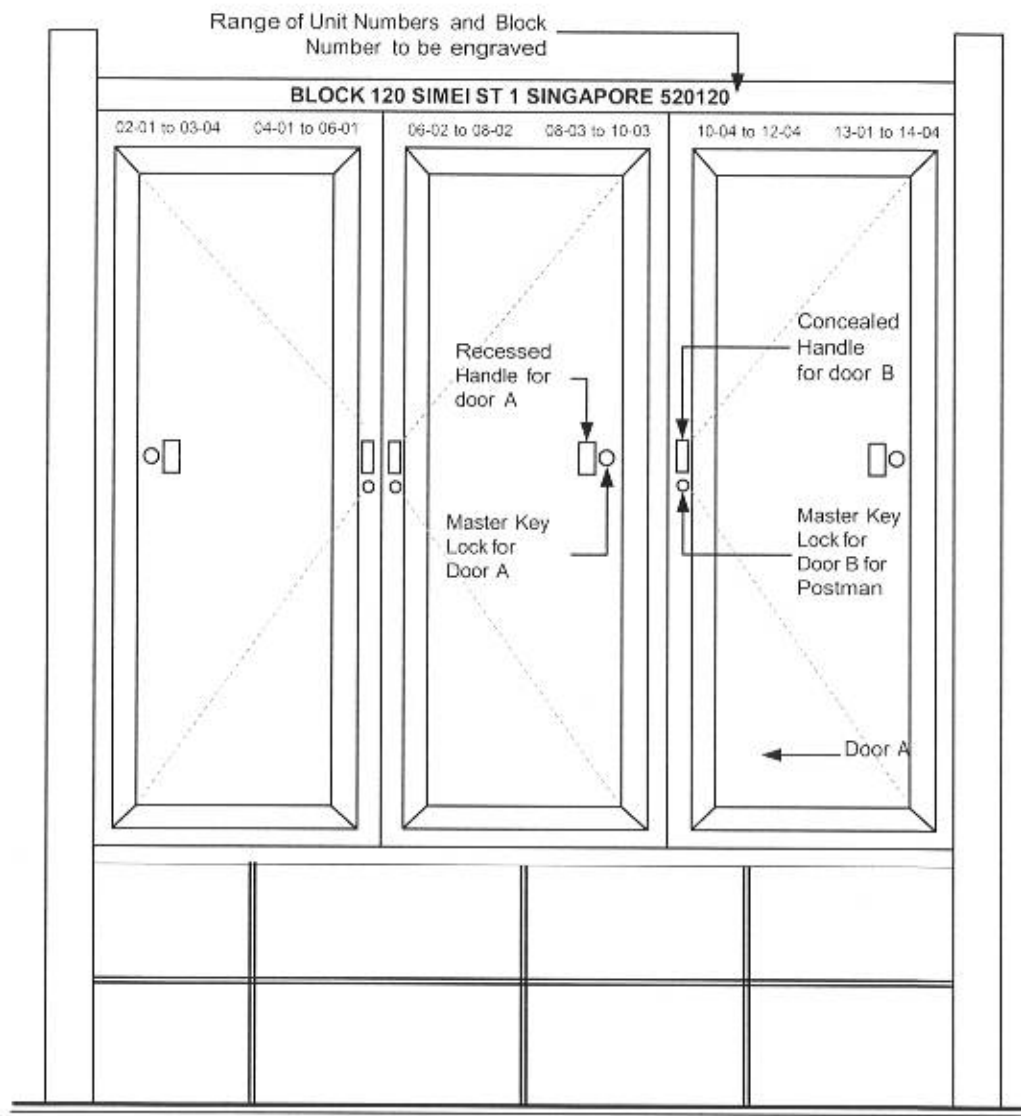

REAR VIEW WITH DOORS CLOSED



### 3-Way Front/Back Opening Letter Box

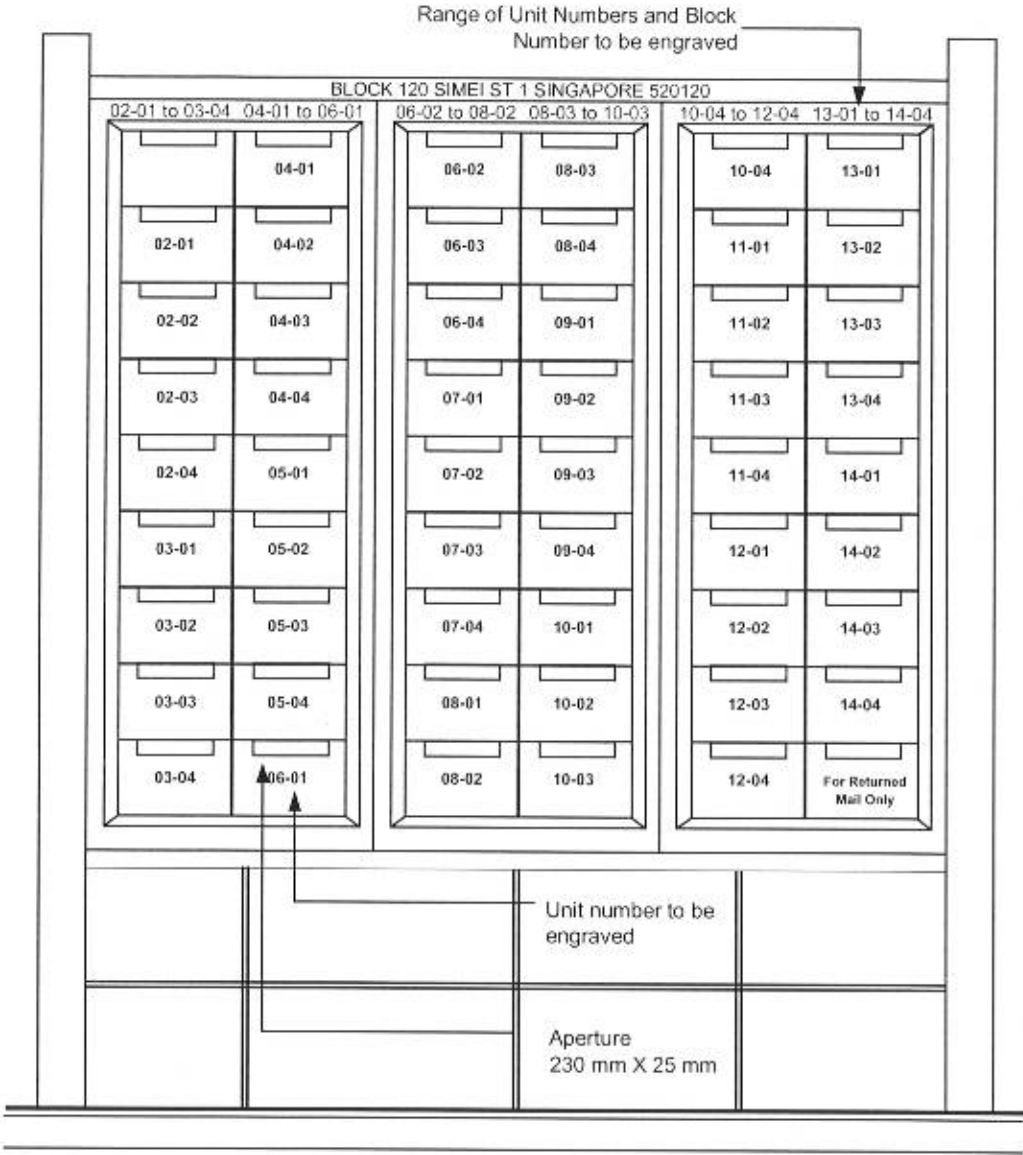

**REAR VIEW WITH DOOR "A" OPEN**

NOTE : The numbering sequence is from top-to-bottom from let-to-right order

### 3-Way Front/Back Opening Letter Box

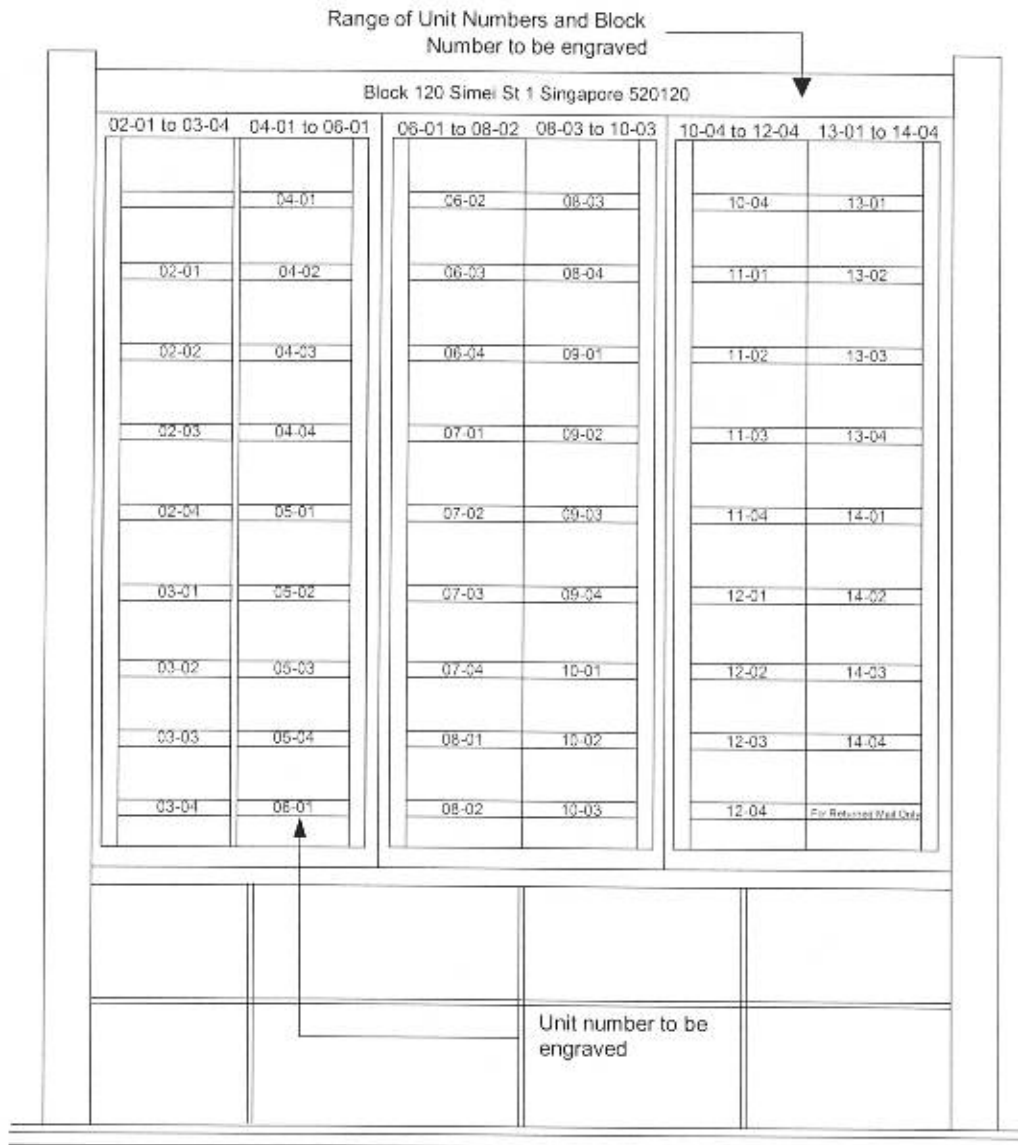

#### REAR VIEW WITH DOOR "B" OPEN

NOTE : The numbering sequence is from top-to-bottom from left-to-right order

### Size of Masterdoor and Opening

The size of each masterdoor is not to exceed three columns of letter boxes to avoid door sagging due to excessive weight of the masterdoor. The door hinges must be of good quality and construction. The masterdoor must be symmetrically opening type.

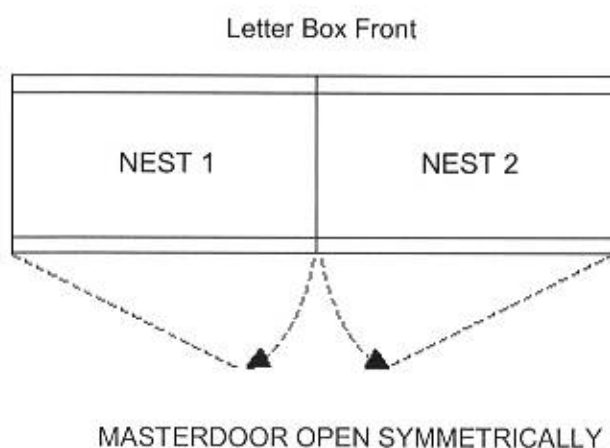

Drawing A

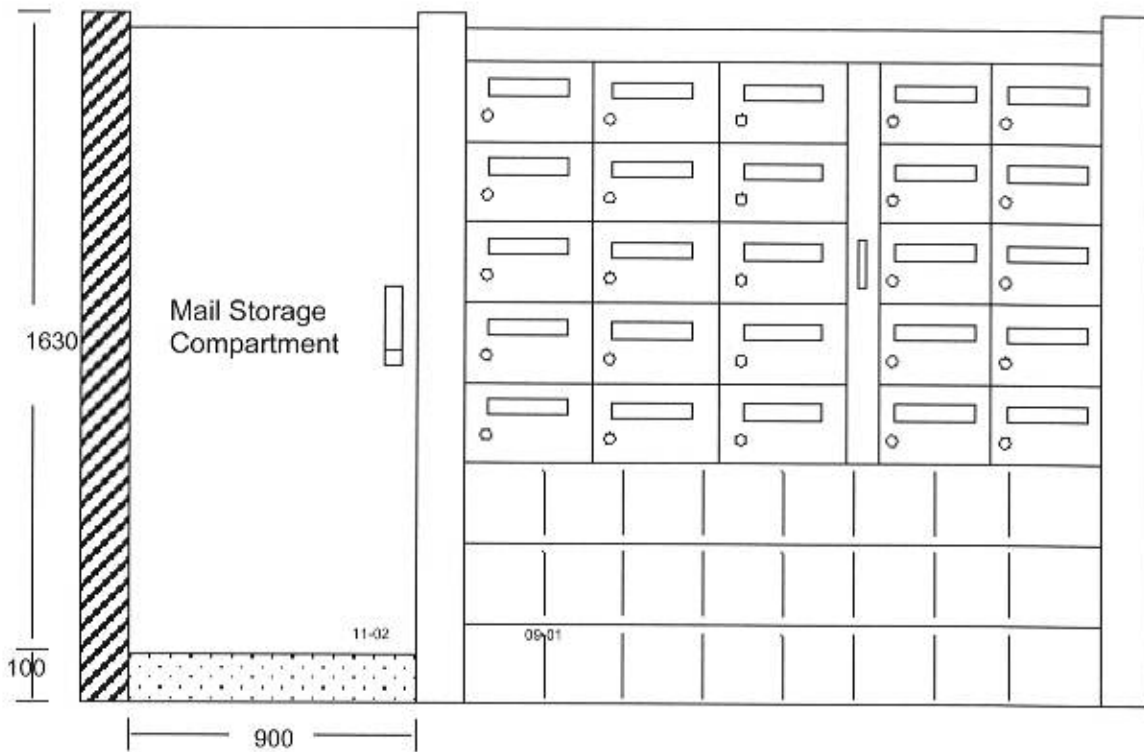

Drawing B

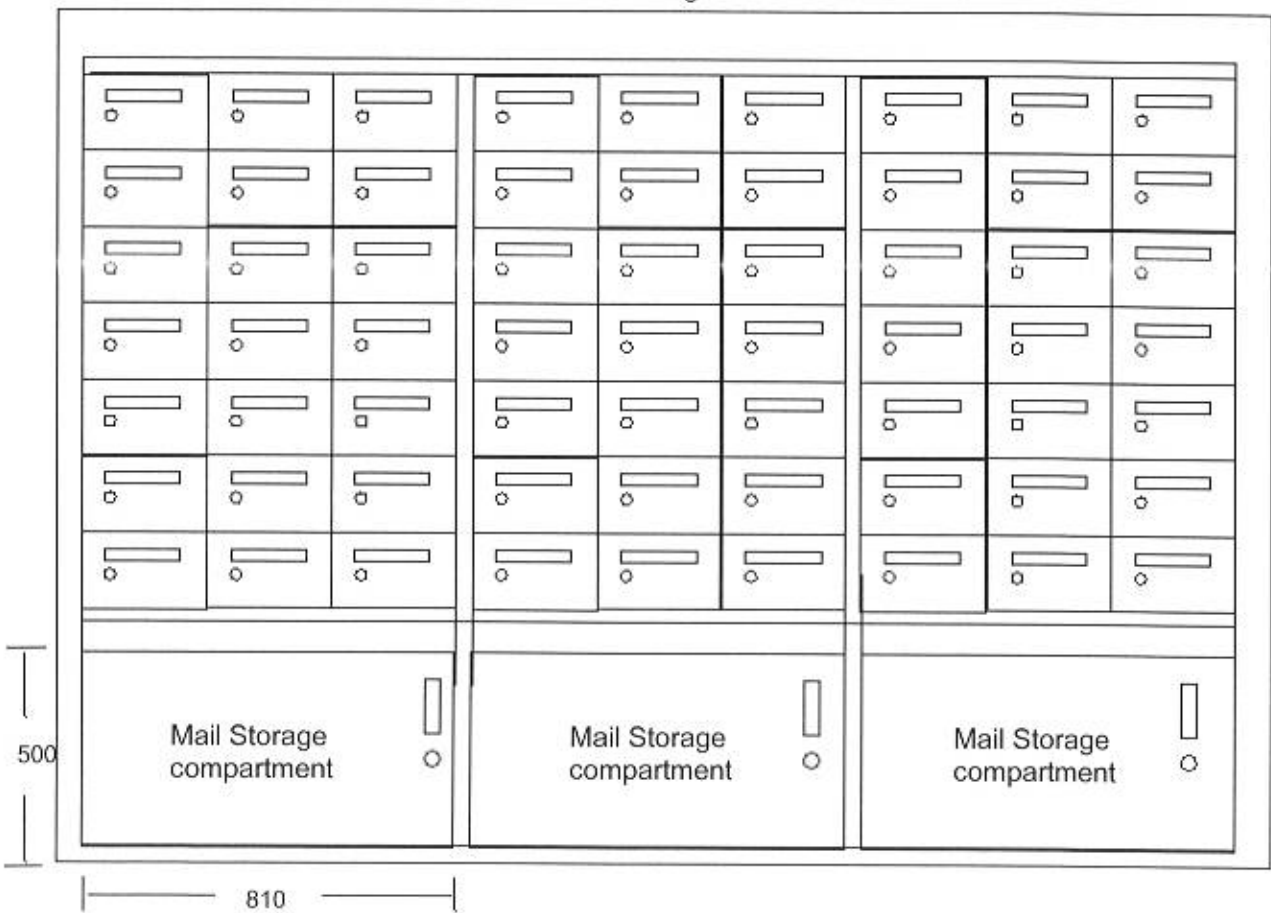

Note: Dimensions (mm) are approximate

## Outdoor Letter Boxes for Single Premises

### Gate Pillar Letter Box

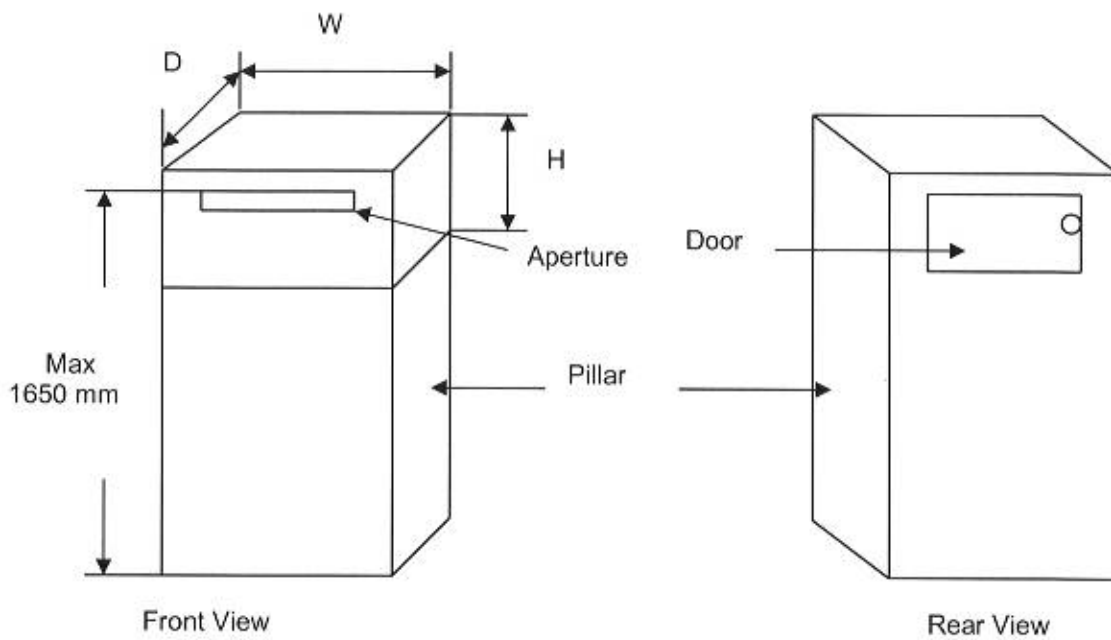

### Stand-Alone Letter Boxes

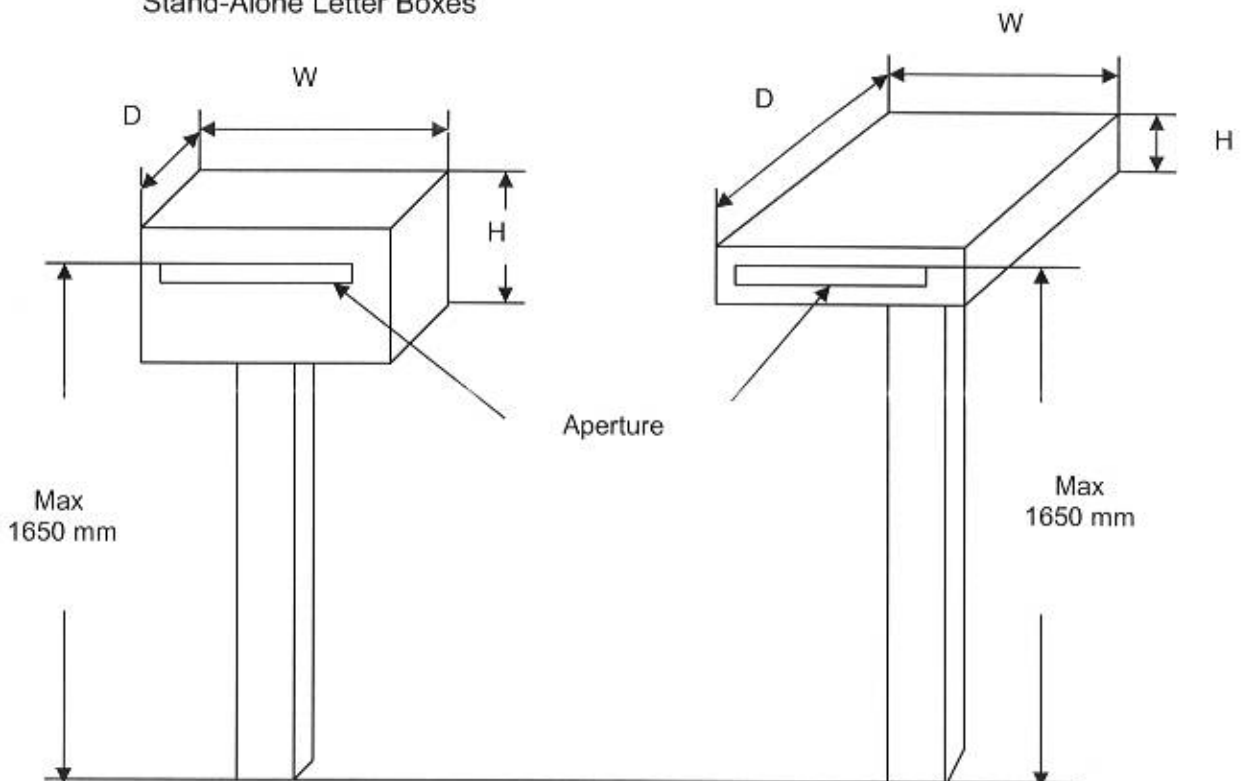

NOTE : All dimensions are internal dimensions (mm)

Dimensions for Gate Pillar and Stand-Alone Letter Boxes are as follows :-

- Residential premises : 110 (H) x 270 (W) x 380 (D) or 380 (H) x 270 (W) x 150 (D)
- Business premises : 150 (H) x 270 (W) x 380 (D) or 380 (H) x 270 (W) x 150 (D)