



## Telecommunications Standards Advisory Committee (TSAC)

---

## Next Generation National Broadband Network (NGNBN)

---

## Optical Fibre Deployment

Part 3 – Connecting and Splicing  
Fibres

---

### **IMDA RD OFD – Part 3 Issue 1, 1 October 2016**

Info-communications Media Development Authority  
Resource Management & Standards  
10 Pasir Panjang Road  
#10-01 Mapletree Business City  
Singapore 117438

© Copyright of IMDA, 2016

This document may be downloaded from the IMDA website at <http://www.imda.gov.sg> and shall not be distributed without written permission from IMDA.

## Acknowledgement

The Info-communications Media Development Authority (IMDA) and the Telecommunications Standards Advisory Committee (TSAC) would like to acknowledge the following members of the Technical Committee Working Group 1 (TSTC WG1) for their invaluable contributions to the preparation of this Reference Specification:

Chairman: Dr Yeo Yong Kee, A\*STAR/I<sup>2</sup>R

S/N	Organisation	Name
1	A*STAR/Institute for Infocomm Research (I <sup>2</sup> R)	Dr Chen Jian, Research Scientist
2		Mr Liaw Chin Yi, Senior Research Officer
3		Dr Wang Yixin, Senior Research Scientist
4		Dr Cheng Xiaofei, Senior Research Fellow
5		Dr Park Chul Soo, Research Fellow
6		Dr Rong Weifeng, Research Fellow
7		Dr Shao Xu, Senior Research Fellow
8	BICSI Southeast Asia	Mr Christopher Thiam Boon Kwee, Director RFX Solutions Pte Ltd
9	M1 Limited	Mr Tan Pek Tong, Senior Manager
10	Media Development Authority	Mr Lim Chin Siang, Director (IT & Technologies)
11	National University of Singapore	A/Prof. Yu Changyuan, Assistant Professor
12	Nucleus Connect Pte Ltd	Ms Khor Lay Khim, Senior Manager
13	OpenNet Pte Ltd	Mr Tiong Oon Seng, Project Director
14	Singapore Telecommunications Ltd	Mr Wong Ching Ping, Deputy Director (International Private IP Engineering)
15		Mr Tan Yoke Yin, Deputy Director (Access System Engineering)
16	StarHub Ltd	Mr Tan Yong Teck, Principal Engineer

In addition, IMDA would like to thank Mr Varghese Paulose, A\*STAR/I<sup>2</sup>R for his editorial contributions to this document.

## Telecommunications Standards Advisory Committee (TSAC)

TSAC is responsible for the strategic direction, work programmes and procedures for standards-setting, and acts as the advisory body to IMDA in meeting the needs of all stakeholders.

TSAC is supported by a Technical Committee (TSTC) where professional, trade and consumers' interest in information and communications is represented by a wide sector of the information and communications industry, comprising network operators, equipment suppliers and manufacturers, academia and researchers, professional bodies and other government agencies.

### TSAC Membership (2009-2011)

#### TSAC Chairman:

Mr Raymond Lee                      Director (Resource Management & Standards), Infocomm Development Authority of Singapore

#### TSAC Members:

Mr Lim Yuk Min (TSAC Vice-Chairman)	Deputy Director (Resource Management and Standards), Infocomm Development Authority of Singapore
Mr Darwin Ho Kang Ming	Vice President, Association of Telecommunications Industry of Singapore
Mr Lim Chin Siang	Director (IT & Technologies), Media Development Authority
Mr Patrick Scodeller	Chief Technical Officer, M1 Limited
Assoc Prof Li Kwok Hung	Nanyang Technological University, School of Electrical & Electronic Engineering
Prof Ko Chi Chung	National University of Singapore, Department of Electrical & Computer Engineering
Assoc Prof Tham Chen Khong	National University of Singapore, Department of Electrical & Computer Engineering
Mr Simon Smith	Senior Manager Regulatory, Pacnet Internet (S) Ltd
Mr Edwin Lok	Manager (Engineering), Pacnet Internet (S) Ltd
Mr Lee Siak Kwee	Director (Mobile Network Access), Singapore Telecommunications Ltd
Mr Tan Seow Nguan	Director (Network System Engineering), Singapore Telecommunications Ltd
Mr Lim Cheow Hai	Director (Access Engineering), Singapore Telecommunications Ltd
Mr Soh Keng Hock	Director (Private IP Engineering & VAS), Singapore Telecommunications Ltd
Mrs Leong Suet Mui	Principal Technical Executive (Standards Division), Spring Singapore
Mr Peter Cook	Vice President (Network Mobile Technology & Planning Group), StarHub Ltd
Mr Mah Chin Paw	The Institution of Engineers, Singapore, AGM (Guthrie Engineering (S) Pte Ltd

Mr Liang Seng Quee Deputy Director (Network Infrastructure), Infocomm Development Authority of Singapore

Ms Woo Yim Leng Senior Manager (Resource Management & Standards), Infocomm Development Authority of Singapore

**TSAC Secretariat:**

Ms Tay Siew Koon Manager (Resource Management & Standards), Infocomm Development Authority of Singapore

# Contents

Section	Title	Page
1.	Scope	3
2.	Abbreviations	3
3.	Types of Connectors	4
4.	Adapters	7
5.	Connector Polishing	9
6.	Problems that Could Arise During Connecting	10
7.	Optical Parameters	11
8.	Characterisation of Optical Parameters	12
9.	Mechanical Effects on Splice Loss	13
10.	Environmental Impact on Splice Loss	14
11.	Fibre Splicing	15
12.	Arc-fusion Splicing	18
13.	Mechanical Splice	22
14.	References	24
Annex	Corrigendum / Addendum	26

*This Reference Document is a living document which is subject to review and revision.*

*Reference Documents, Specifications and Guides are informative documents and are not used for approval of customer equipment. They are either one of the following types of documents:*

*Informative and interim documents on customer equipment standards which are yet to be adopted by network operators; or*

*Informative documents describing network standards and practices adopted by the public telecommunication networks in Singapore.*

**NOTICE**

**THE INFO-COMMUNICATIONS MEDIA DEVELOPMENT AUTHORITY (“IMDA”) MAKES NO WARRANTY OF ANY KIND WITH REGARD TO THE MATERIAL PROVIDED HEREIN AND EXCLUDES ANY EXPRESS OR IMPLIED WARRANTIES OR CONDITIONS OF NON-INFRINGEMENT, MERCHANTABILITY, SATISFACTORY QUALITY AND FITNESS FOR A PARTICULAR PURPOSE. SUBJECT TO THE MAXIMUM EXTENT PERMITTED UNDER LAW, IMDA SHALL NOT BE LIABLE FOR ANY ERRORS AND/OR OMISSIONS CONTAINED HEREIN OR FOR ANY LOSSES OR DAMAGES (INCLUDING ANY LOSS OF PROFITS, BUSINESS, GOODWILL OR REPUTATION, AND/OR ANY SPECIAL, INCIDENTAL OR CONSEQUENTIAL DAMAGES) IN CONNECTION WITH THE USE OF THIS MATERIAL.**

**IMDA DRAWS ATTENTION TO THE POSSIBILITY THAT THE PRACTICE OR IMPLEMENTATION OF THIS STANDARD MAY INVOLVE THE USE OF INTELLECTUAL PROPERTY RIGHTS AND TAKES NO POSITION CONCERNING THE EXISTENCE, VALIDITY AND/OR APPLICABILITY OF ANY SUCH INTELLECTUAL PROPERTY RIGHTS, WHETHER ASSERTED BY TSAC MEMBERS OR ANY THIRD PARTY.**

**AS OF THE DATE OF APPROVAL OF THIS STANDARD, IMDA HAS NOT RECEIVED WRITTEN NOTICE OF ANY PATENT RIGHTS WHICH MAY BE RELEVANT IN RELATION TO THE IMPLEMENTATION OF THIS STANDARD. HOWEVER, IMPLEMENTERS ARE CAUTIONED THAT THIS MAY NOT REPRESENT THE LATEST INFORMATION AND ARE THEREFORE STRONGLY URGED TO CHECK WITH THE RELEVANT DATABASE IN ITU, ISO, IEC OR THE RELATED STANDARDS DEVELOPMENT ORGANISATION FOR INFORMATION OF PATENT RIGHTS. IMPLEMENTERS ARE ADVISED TO OBTAIN THEIR OWN LEGAL AND/OR TECHNICAL ADVICE IN RELATION TO THE IMPLEMENTATION OF THE STANDARD IF REQUIRED.**

# Connecting and Splicing Fibres

## 1 Scope

Fibre connection is one of the most important steps in optical network installation. As the signal transmission method in fibres is very different from that of copper, many special techniques are required to prepare and mechanically join two sections of fibres. A non-permanent connection requires a fibre adapter while a permanent one requires a fusion splice. This section introduces different types of connectors, adapters and endface polish types. It also covers how two fibres are spliced together to produce a very low loss joint. In addition, there is also information on how to characterise the mechanical and optical performances of a connection.

## 2 Abbreviations

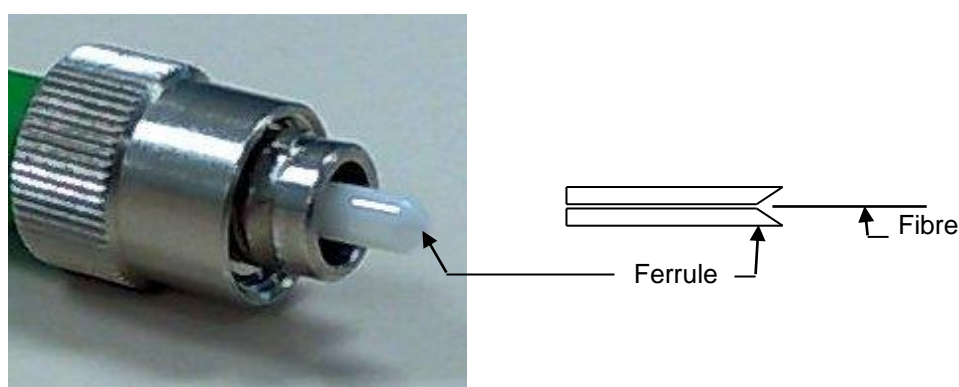
This Reference Specification uses the following abbreviations:

SMF	Single-mode Fibre
MMF	Multi-mode Fibre
PC	Physical Contact
FC	Ferrule Connector
APC	Angle-polished Connector
LC	Lucent Connector
SC	Standard Connector
FOCIS	Fibre Optic Connector Intermateability Standards
ST	Straight Tip Connector
SPC	Super Physical Contact
UPC	Ultra Physical Contact
IL	Insertion Loss
RL	Return Loss
dB	Decibels
dBm	Decibel with Reference to 1 milliwatt
W	Watts
OTDR	Optical Time Domain Reflectometer
PAS	Profile-alignment System
PAT	Power-alignment Technology
UV	Ultra-violet

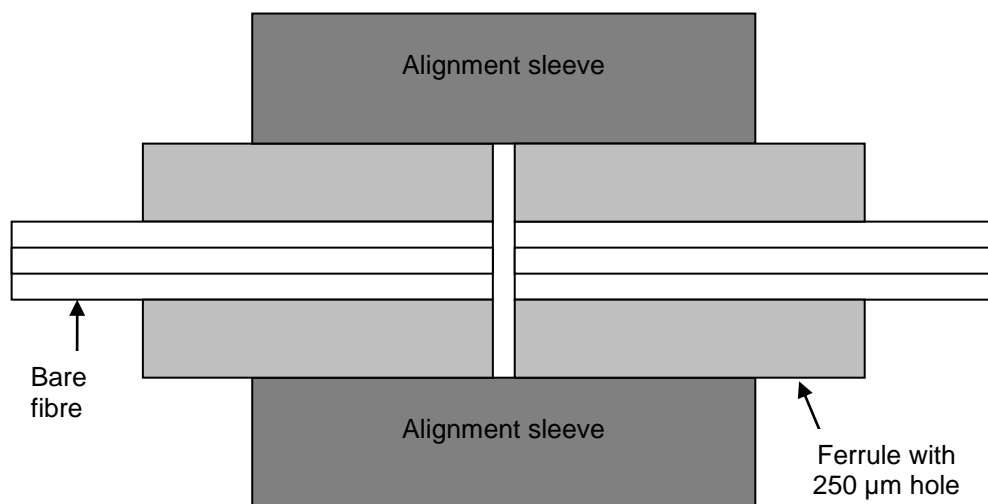
### 3 Types of Connectors

An optical fibre connector is a termination at the end of an optical fibre. Two connectors can be mechanically connected by aligning the core of one fibre to another so that light can pass through with very low power loss. Most connectors are spring-loaded so that the endfaces of the two fibres can come into physical contact, and this is to avoid the formation of an air-gap, which causes unnecessary reflections. Connectors are designed to withstand repeated connections and disconnections.

Most connectors use a ferrule to assist the alignment between two connectors. A ferrule is an aluminium or ceramic cylinder tube with a precision-drilled hole in the centre to hold the fibre. To connectorise a fibre, the protective jacket and coating of the fibre are first stripped to expose the bare fibre. Then the bare fibre is cleaned and cleaved before it is inserted into the hole of the ferrule. An epoxy is used to fix the position of the fibre in the ferrule. Upon curing of the epoxy, the endface of the ferrule is ground and polished to achieve an optical grade of flatness.



**Figure 1: Positioning a Fibre in a Ferrule**



**Figure 2: An Alignment Sleeve is used in the Mating Adapter to Aid Ferrule Alignment**

There are a wide variety of connectors available and they are categorised according to their physical dimensions and endface polish type. The buffer or jacket on the fibre patch cords are colour-coded to indicate the type of fibre used and the colour coding system is based on EIA/TIA-598 [1]. The jacket colour of a single-mode optical fibre (SMF) is yellow whereas the jacket colour of multi-mode optical fibre (MMF) is orange. The core diameter of a single-mode fibre is around 9µm and the core diameter of a MMF is 50 or 62.5 µm. So 9/125 fibre means the fibre core diameter is 9 µm and the cladding is 125 µm, and 62.5/125 means the fibre has a core diameter of 62.5 µm while the cladding diameter is



125 µm.

The following are the most commonly used fibre optic connectors.

### 3.1 Ferrule Connector

Ferrule Connector, or FC connector in short, has been standardised in FOCIS 4 (Fibre Optic Connector Intermateability Standards) in EIA/TIA-604-04 [2]. IEC 61754-13 [3] defines the standard interface dimensions for the FC-PC type family of connectors. The FC connector uses a single male key to assist the orientation of the plug to the mated component. It uses a spring-loaded physical contact mechanism to allow the fibre ends to make contact.



Figure 3: FC/PC Connector with 3mm Jacket



Figure 4: FC/APC Connector with 3mm Jacket

### 3.2 Lucent Connector

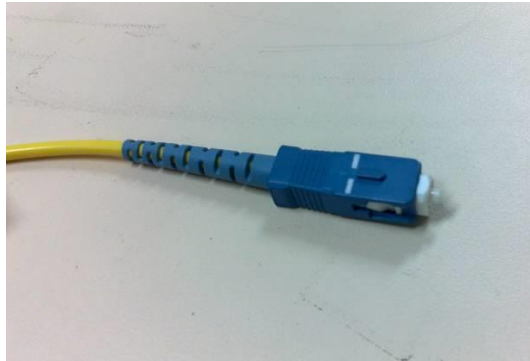
Lucent Connector, or LC connector for short, conforms to the IEC 61754-20 standard [4] that defines the standard interface dimensions for the type LC family of connectors. It has a snap-in type coupling and is typically used in patch panels with a high density of connectors. It is commonly used in SFP transceivers as well. The ferrule diameter of the connector is 1.25 mm.



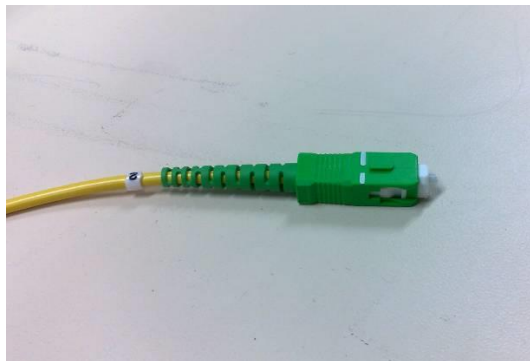
**Figure 5: LC/UPC Connector with 3mm Jacket**

### 3.3 Standard Connector

Standard Connector, or SC connector for short, has a push-pull latching mechanism that allows easy insertion and removal while ensuring a correct orientation. The SC connector has been standardised as FOCIS 3 in EIA/TIA-604-03 [5]. Its ferrule diameter is 2.5 mm and it is commonly used in datacom and telecom equipment.



**Figure 6: SC/PC Connector with 3mm Jacket Cable**



**Figure 7: SC/APC Connector with 3mm Jacket Cable**

### 3.4 ST Connector

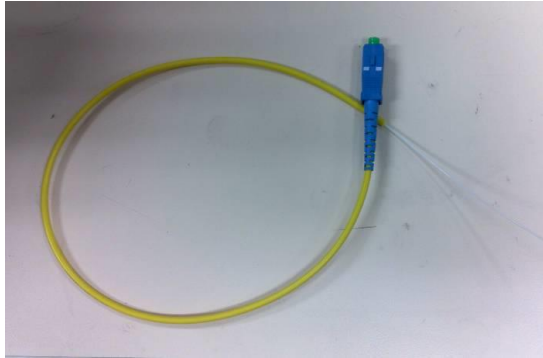
Straight Tip connector, or ST connector for short, is a trademark of AT&T. It is specified by the TIA as FOCIS-2 and has a bayonet mount and a 2.5 mm ceramic ferrule to hold the fibre. It is spring-loaded and has a key which prevents rotation of the ceramic ferrule.



**Figure 8: ST/PC Connector with 3mm Jacket Cable**

For more information on connections, please refer to ITU-T Rec. L.36 [6]. This recommendation covers the optical and mechanical performance testing of connectors as well as their identification and characteristics.

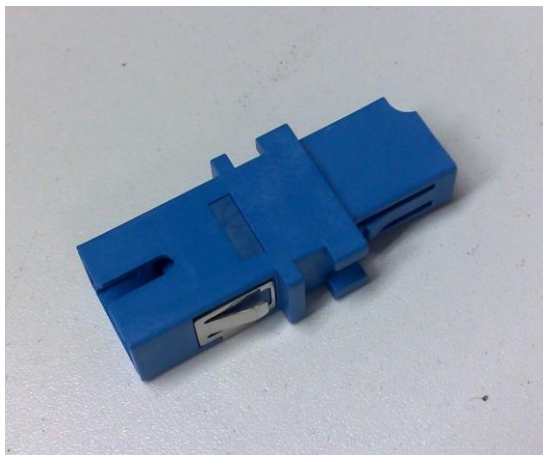
After a fibre is connectorised, it can be stored or manipulated in the form of a fibre pigtail. A fibre pigtail is a fibre cable that has an optical connector on one end and a short section of exposed fibres on the other. The fibres can then be spliced to other fibres that are part of a fibre link or an optical component.



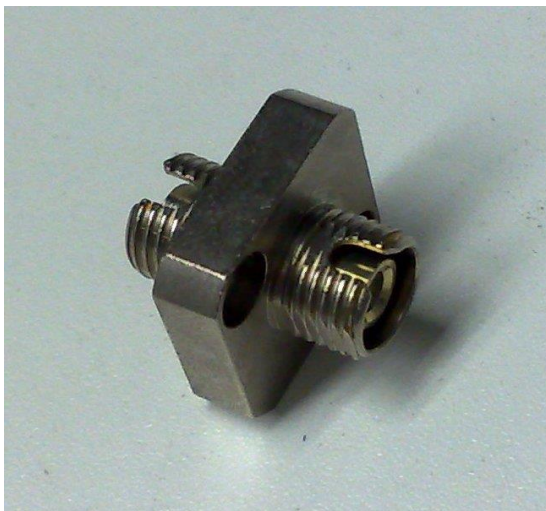
**Figure 9: A Pigtail Fibre with SC/PC Connector**

#### **4 Adapters**

An adapter is used for joining two connectors together and is also colour coded to indicate whether the polish type is PC (Blue) or APC (Green). There are various kinds of adapters available and they can be used to mate two different types of connectors. Some commonly used adapters are shown below.



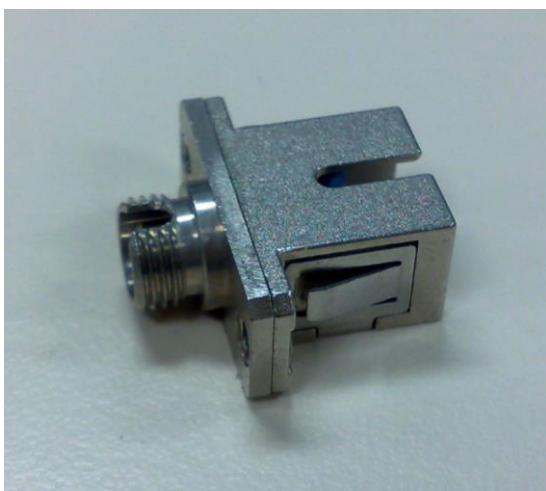
**Figure 10: SC-to-LC Adapters**



**Figure 11: FC-to-FC Adapter**



**Figure 12: LC-to-LC Adapter**



**Figure 13: FC-to-SC Adapter**

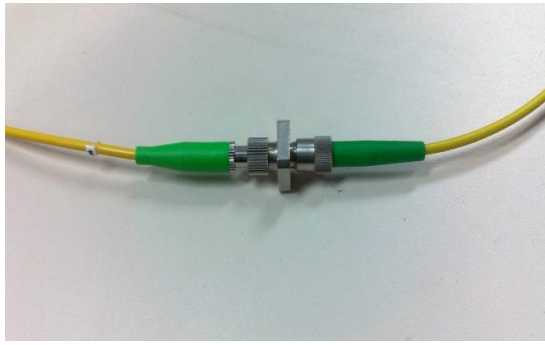


Figure 14: FC/APC Cables Connected via an FC-to-FC Adapter

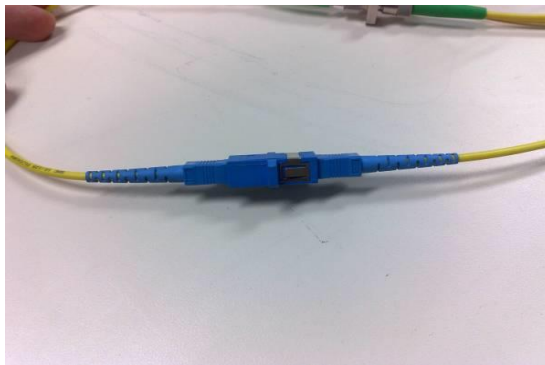


Figure 15 SC/PC Cables Connected via an SC-to-SC Adapter

## 5 Connector Polishing

The endface of a ferrule can be polished using a few techniques: PC (for physical contact), SPC and UPC for "super" and "ultra" polish, respectively. Higher grades of polish will provide lower insertion loss and lower back reflection. If a FC connector is designated "FC/PC", it means that its endface is physical contact polished. The polished surface is slightly curved so that when fibres are mated, only the fibre cores touch, not the surrounding ferrules. Similarly, "FC/APC" denotes that the fibre endface is Angle-polished.

Angle-polished connectors (APC) are designed for applications requiring very low back reflection, and they can only be mated to another APC connector (note that high insertion loss will result when an APC connector is mated to a non-APC adapter). APC connectors are designed to have low reflections even when their output end is not connected. However, such connectors tend to have higher insertion loss as compared to physical contact connectors. The colour of the connector boot indicates the type of polishing method used. For example, green is for APC while black and blue is for PC.

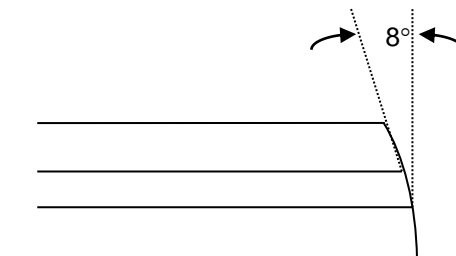
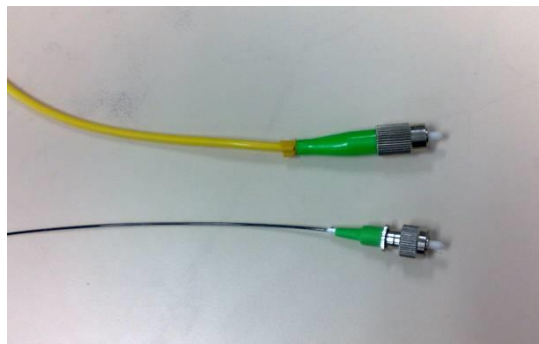


Figure 16: Ferrule Endface of an APC Connector

The ferrule endface is polished at an angle of  $8^\circ$  with respect to the lateral direction of the fibre. A polishing angle of  $8^\circ$  causes the reflected light to propagate at an angle larger than the acceptance angle, and thus the reflected light will be directed into the fibre cladding. That is why an APC connector has significantly better return loss performance than a PC connector.



**Figure 17: Ferrule Endface of a PC Connector**

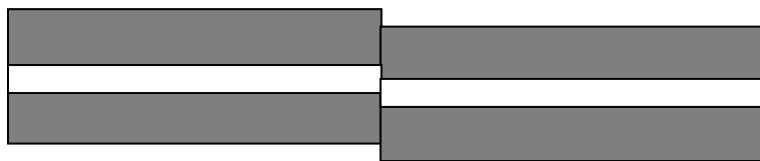


**Figure 18: FC/APC Connector with 3mm Jacket versus FC/APC Connector with 900 $\mu$ m Tight Buffer**

## 6 Problems that Could Arise During Connecting

### 6.1 Core Misalignment

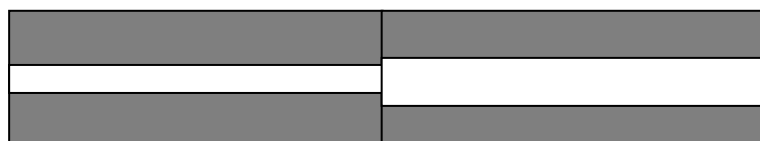
The lateral misalignment of the fibres causes optical power losses because the fibre cores do not overlap sufficiently.



**Figure 19: Core Misalignment**

### 6.2 Mismatch of Core Diameter

This happens when two fibres with different core diameters are joined together. The mode field diameters and core diameters are different, resulting in high insertion loss at the connection.



**Figure 20: Mismatch of Core Diameter**

### 6.3 Dirt at the Endface of the Ferrule

Dirt at the endface of the ferrule prevents the endface from coming into full contact, and this obstructs the light propagating from one fibre to another, thus resulting in high insertion loss. It is a good practice to clean the ceramic ferrule before each connection to remove dirt.

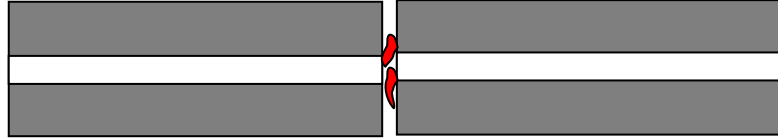


Figure 21: Dirt Particle Trapped between Two Fibres

### 6.4 Formation of an Air Gap between Two Ferrules

Formation of an air gap between the endfaces produces reflections between the surfaces and increases the transmission loss.

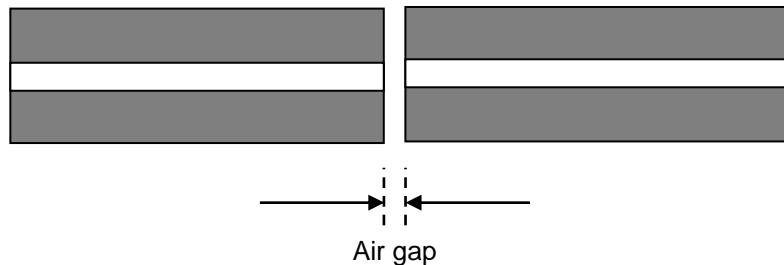


Figure 22: Air Gap between Two Fibres

## 7 Optical Parameters

### 7.1 Optical Attenuation or Insertion Loss

The insertion loss is a measure of the loss of optical power as a result of inserting a device into an optical fibre transmission link. The insertion loss of a splice joint or a connection is also called joint loss. Insertion loss of connectors and splices reduce the overall power budget of a transmission link, and thus should be minimised.

The unit for insertion loss is dB and the equation is  $10\text{Log}(P_{\text{out}}/P_{\text{in}})$ , where  $P_{\text{out}}$  and  $P_{\text{in}}$  are the output and input power, respectively, and the units of  $P_{\text{out}}$  and  $P_{\text{in}}$  are in Watts.

### 7.2 Return Loss

When optical components in a transmission system reflect too much light back to the transmitter, the modulation characteristics and spectrum of the laser changes. This could lead to signal distortion and even system failure. To quantify and measure how much optical power is being reflected by a particular device, a parameter called Return Loss is used. High return loss values indicate that the device has very little reflection. Low reflection is desirable in high-speed communication systems. A typical FC/PC connector has a return loss in the range of 30dB to 45dB. FC/APC connectors can achieve return loss up to 60dB.

## 8 Characterisation of Optical Parameters

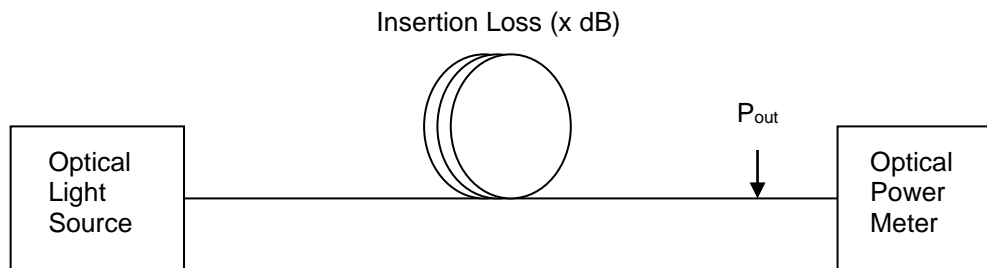
The recommended measurement techniques for single-mode fibre splices are: IEC 61300-3-7 [7] for

attenuation or insertion loss and IEC 61300-3-6 [8] method 1 or 2 for return loss (RL).

## 8.1 Attenuation/Insertion Loss (IL)

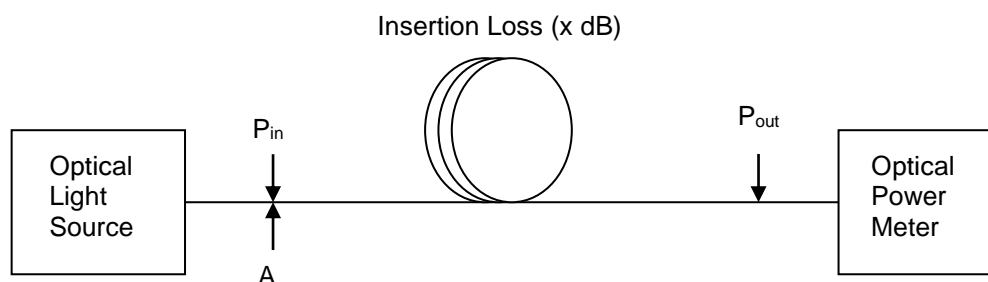
IEC 61300-3-7 [7] describes the various methods that can be used to measure the wavelength dependence of attenuation and return loss of passive optical components used in optical fibre networks.

The cut-back technique can be used to measure the attenuation characteristics of a long length of fibre under test.



**Figure 23: Received Power is First Measured**

DUT (Device under test) is a roll of optical fibre. The optical power received at the exiting end of the fibre is first measured and recorded as  $P_{out}$  (dBm or W).



**Figure 24: Fibre is Cut at Point A and the Power is Measured**

Next the fibre is cut at point A and the launched optical power is measured and recorded as  $P_{in}$  (dBm or W).

Then the insertion loss is calculated from the equation:

$$\text{Insertion Loss (dB)} = 10 \log (P_{out}/P_{in}), \text{ where } P_{out} \text{ and } P_{in} \text{ are in Watts.}$$

If  $P_{out}$  and  $P_{in}$  are measured in dBm, Insertion Loss (dB) =  $P_{out} - P_{in}$ .

The attenuation loss is calculated by the equation:

$$\text{Attenuation Loss (dB/km)} = \text{Insertion loss (dB)} / \text{Length of fibre (km)}$$

## 8.2 Return Loss (RL)

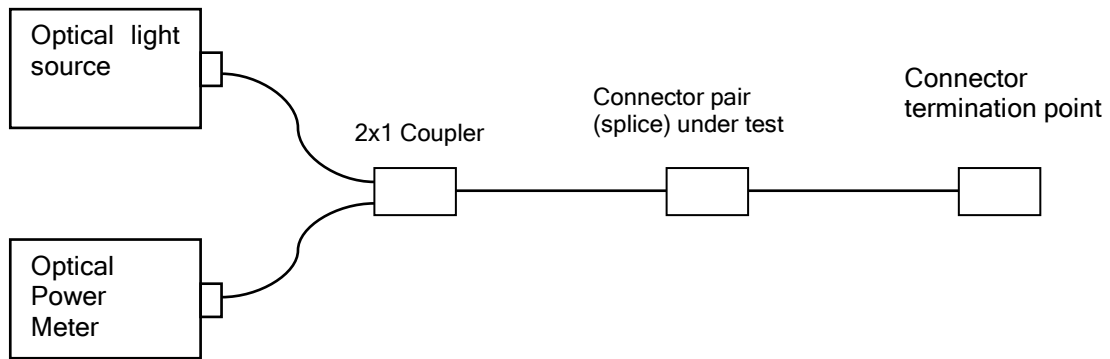
Return loss is a measure of how much light is being reflected back to the transmitter. IEC 61300-3-6 [8] presents procedures for the measurement of the return loss (RL) of a fibre optic device under test



(DUT). The RL, as defined in this standard, is the ratio of the power ( $P_i$ ) entering the DUT to the total power reflected ( $P_r$ ) by the DUT, expressed in decibels.

$$\text{Return Loss (dB)} = 10\log(P_i/P_r)$$

Figure 25 shows a measurement set-up used for measuring return loss. The reflected optical power is measured by the optical power meter.



**Figure 25: Experimental Set-up for Measuring the Return Loss of a Connector/splice Joint**

### 8.3 OTDR Measurement (IEC/TR 62316)

This document contains guidelines for interpreting backscattered traces using the optical time domain reflectometer (OTDR) technique. The principle behind the OTDR technique is described in IMDA RS OFD – Part 4. A full description of the measurement procedure can be found in Annex C of IEC 60793-1-40 [9].

### 8.4 Other Techniques for Return Loss Measurement

More techniques for return loss measurement can be found in (EIA/TIA-455-107) [10].

## 9 Mechanical Effects on Splice Loss

Mechanical parameters describe how the performance of the fibre optic splice is affected by mechanical effects such as vibration, torsion, retention, and so on.

Standard	Description
Vibration (IEC 61300-2-1) [11]	This document contains test and measurement methods for evaluating the effects of vibration on fibre optic devices at the mechanical vibration frequency ranges (and magnitudes) that may be encountered during operation.
Strength of the coupling mechanism (IEC 61300-2-6) [12]	The purpose of this document is to ensure that the coupling mechanism of a connector set or connector-device combination can withstand the axial loads likely to be encountered during normal use.

<p>Fibre retention (IEC 61300-2-4) [13]</p>	<p>Conformance to this specification will ensure that the fibre or cable that is attached to a fibre optic device can withstand tensile loads likely to be encountered during operation. The specimen is clamped to a fixture and tensile load is applied. The severity of the test can be varied by changing the magnitude of the load and the time duration where the force is applied.</p>
<p>Torsion (IEC 61300-2-5) [14]</p>	<p>This document contains a test method to determine the ability of the cable attachment element of a test device for withstanding torsional loads that might be encountered during its operational lifetime. The cable attached to the device is subjected to a torsional load or twisting to determine the effect of such actions on the mechanical and optical properties of the test specimen. The load applied and the number of twist cycles can be varied according to the test severity.</p>
<p>Mechanical endurance (IEC 61300-2-2) [15]</p>	<p>This document contains a test method for evaluating the optical performance and mechanical degradation of fibre optic connectors after they are subjected to repeated cycles of engagement and disengagement.</p>
<p>Shock (IEC 61300-2-9) [16]</p>	<p>This document focusses on the mechanical weakness and/or degradation of fibre optic devices when they are exposed to mechanical shocks that may be encountered during operation or during transportation. The test simulates non-repetitive shocks that are infrequent in nature and the specimen is attached to the table of a shock-testing machine. Half-sine shock pulses are applied and the peak acceleration and number of shocks can be varied.</p>

## 10 Environmental Impact on Splice Loss

Environmental effects such as temperature, humidity, dust, and so on, can affect the performance of fibre optic splices. They are the subject matter for the following qualification standards.

Standard	Description
<p>Cold ambient conditions (IEC 61300-2-17) [17]</p>	<p>This test determines the ability of a fibre optic device to withstand extended low temperature ambient conditions that may occur during operation, storage and transport. The temperature of the test chamber is lowered at a rate of 1 deg C/min over a duration of 5 minutes and then maintained at a specific temperature over a fixed period of time. The chamber temperature is then raised to ambient level before the final measurements are made.</p>
<p>Dry heat (IEC 61300-2-18) [18]</p>	<p>This test determines the ability of a fibre optic device to withstand extended high temperature ambient conditions that can be encountered during operation, storage and transport. The purpose of the test is to induce potential failures due to softening and expansions by placing the device in a high temperature environment over an extended period of time. An environmental chamber is used.</p>

<p>Condensation (IEC 61300-2-21) [19]</p>	<p>This test determines the resistance of a fibre optic device under the effects of high temperature, humidity and cold conditions in an accelerated test manner. Through this test, any defects in the specimen that is caused by breathing will be revealed. The test specimen is placed in a humidity chamber and is then subjected to 10 temperature-humidity cycles (24 hr each). Such a test is important for devices that are comprised of different materials.</p>
<p>Temperature variation (IEC 61300-2-22) [20]</p>	<p>This test determines the ability of a fibre optic device to withstand the effects of temperature changes.</p>
<p>Dust – Laminar flow (IEC 61300-2-27) [21]</p>	<p>This test determines the effects of dust on fibre optic devices. The test sample is placed in the centre of a chamber. The sample is then subjected to dusty conditions under varied temperatures, humidity and velocity of air in the chamber.</p>
<p>Salt mist (IEC 61300-2-26) [22]</p>	<p>This test determines the resistance of the metals used in the construction of a device to corrosion, and to also determine if the finishing of metals that are not similar has been properly completed to prevent corrosion.</p>
<p>Water immersion (IEC 61300-2-45) [23]</p>	<p>This test determines a fibre optic component's ability to resist degradation as a result of water immersion. The test sample is immersed in water for a specific duration and the following details are typically included in the specifications: preconditioning procedure, water temperature, depth of immersion, immersion period, number of immersion cycles, and so on.</p>

## 11 Fibre Splicing

Fibre splicing is a method to permanently join two sections of fibres together. ITU-T L.12 [24] contains detailed information on different types of splices, the splicing procedure, and recommended optical and mechanical tests for spliced joints.

There are two widely used methods for splicing: Arc-fusion splicing and mechanical splicing. Before the splicing is carried out, some preparatory steps should be undertaken to ensure a good quality joint.

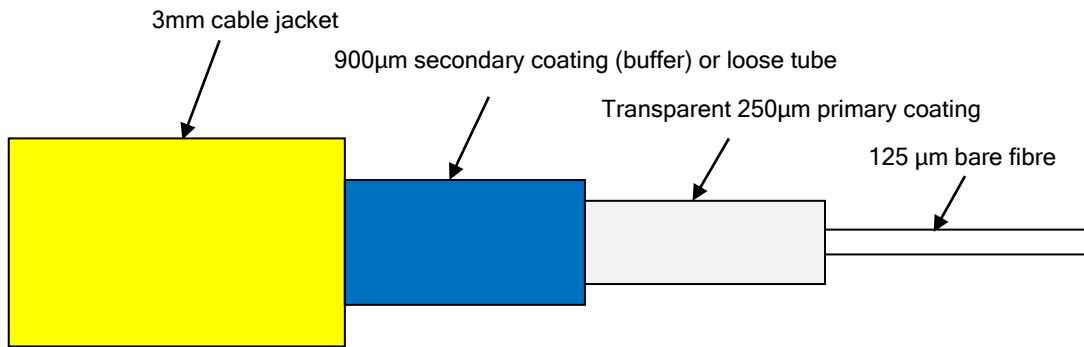
### Preparation Steps

#### i. Coating stripping

Prior to splicing, it is necessary to remove all protective coatings from the ends of each fibre. A fibre stripping tool shown below is used to remove the coatings. It is able to remove the 3 mm outer jacket as well as the 250µm primary coating and 900µm loose tubing.

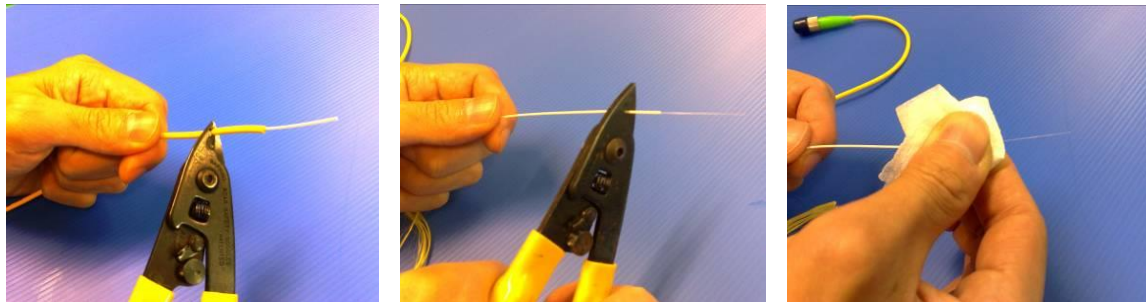


**Figure 26: Photograph of a Fibre Stripping Tool for Removing the Jacket and Primary Buffer Coatings**



**Figure 27: Fibre Optic Cable Prepared for Termination. (The jacket and coatings are stripped to expose the bare fibre.)**

To prepare the fibre for cleaving, the outer coating that is 30 to 40 mm away from the fibre tip is removed with a stripping tool. Next, the stripped portion should be thoroughly cleaned using lint-free paper moistened with at least 99% pure alcohol.



**Figure 28: The Jacket is Stripped Followed by the Secondary and Primary Coating (The bare fibre is cleaned by lint-free tissue soaked with alcohol.)**

### ii. Cleaning of the bare fibre ends

Some dirt particles may get attached to the bare fibre after the coatings are removed. To remove these particles, use lint-free paper dampened with Isopropyl alcohol. The bare fibre, especially the endface, is then gently wiped using the lint-free paper to remove any dirt stuck on its surface.



**Figure 29: Alcohol Dispenser with Alcohol (purity > 99%) and Lint-free Cleaning Paper**

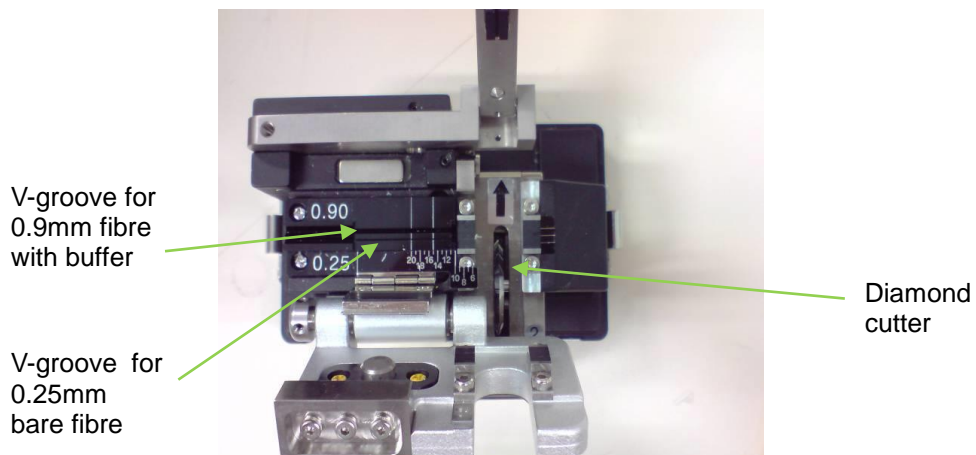
### iii. Cleaving

Cleaving is a process to create a perfectly flat endface, perpendicular to the longitudinal axis of the fibre. This flat surface is critical to ensure the success of the splicing operation.

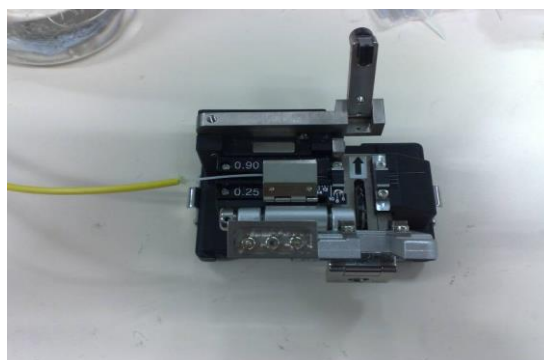
To perform cleaving, the cleaned fibre is placed onto a mechanical cleaver where a diamond blade will slide across the fibre to create a micro-crack. By applying slight pressure to the top of the cleaver, the fracture is allowed to propagate in a controlled manner within the glass fibre. This process creates a perfectly flat endface that is perpendicular to the axis of the fibre.



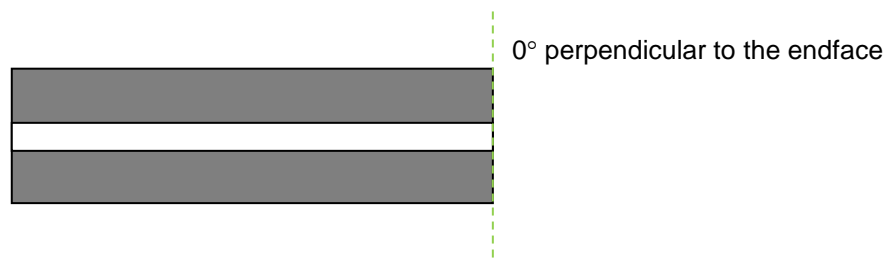
**Figure 30: Photograph of a Mechanical Cleaver  
(Courtesy of Fujikura Ltd)**



**Figure 31: Top View of a Mechanical Cleaver  
(Courtesy of Fujikura Ltd)**



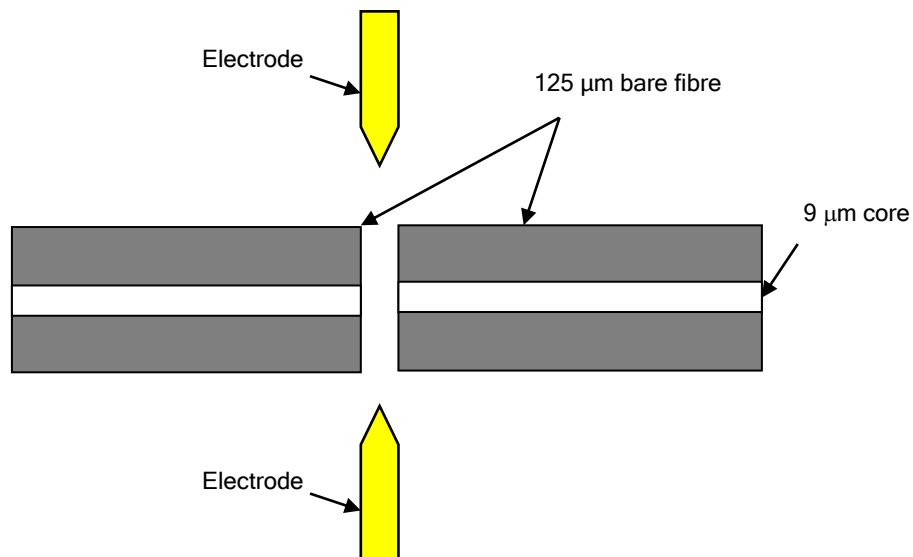
**Figure 32: The Bare Fibre is Positioned and Clamped on  
the Fibre Cleaver before it is Cleaved**



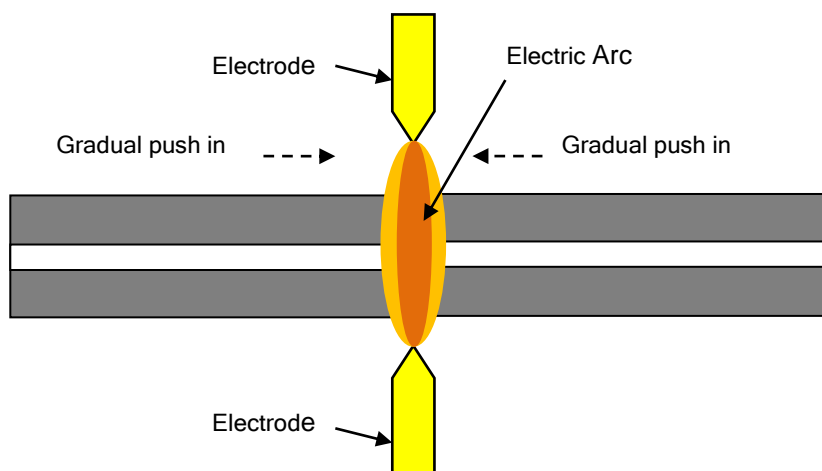
**Figure 33: A Perfectly Flat Endface is Critical for a Good Splice**

## 12 Arc-fusion Splicing

Fusion splicing is a technique used to join the two ends of two optical fibres together by localised heating. The heat source could come from an electric arc, laser or gas flame, and it is used to melt or fuse the ends of two optical fibres together. A typical splice joint has an attenuation loss of 0.01dB to 0.15dB.



**Figure 34: Both Fibres are aligned by PAS Technology in the Splicer**

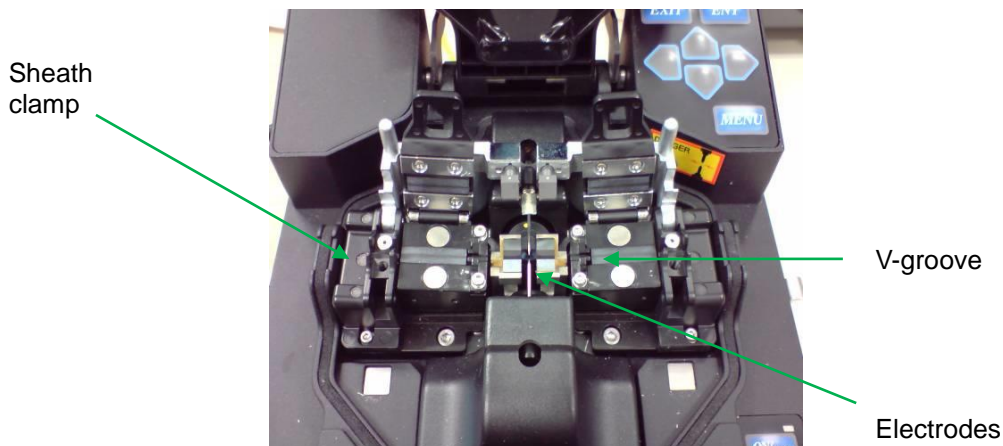


**Figure 35: An Electric Arc is Applied while Both Fibres are Pushed Inwards Simultaneously**

The equipment that performs arc-fusion splicing is known as a fusion splicer. A fusion splicer can splice all types of fibres, such as single-mode fibres (ITU-T G.652 [25]), non-zero dispersion-shifted

single-mode fibres (ITU-T G.655 [26]), and multi-mode fibres (ITU-T G.651 [27]). Some splicers can perform simultaneous splicing of multiple fibres in a ribbon cable as well.

After the fibre ends are prepared for splicing, they are loaded into the splicer. To load the cleaved fibre into the splicer, the wind protector and sheath clamps are both opened up. The prepared fibre is then placed onto the v-groove so that the fibre tip is located between the v-groove edge and the tip of the electrode. Next, the sheath clamp is closed so that the fibre is secured. The other fibre is loaded into the splicer in a similar manner. Finally, the wind protector is closed.



**Figure 36: Photograph Showing Where the Fibre Has to Be Placed in the Fusion Splicer (Courtesy of Fujikura Ltd)**



**Figure 37: Photograph Showing When Both Fibres are Loaded and the Sheath Clamp is Closed (Courtesy of Fujikura Ltd)**

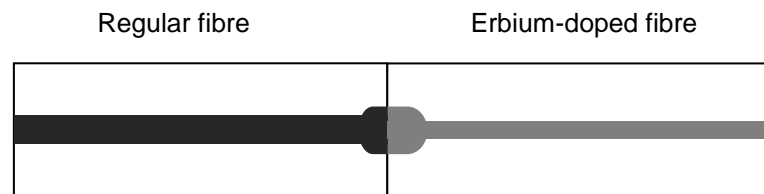
Commercially available fusion splicers use either active fibre alignment or passive fibre alignment to position the fibres in preparation for the arcing process. Active fibre alignment can be further classified into core profile-alignment system (PAS) and power-alignment technology (PAT). In the PAS system, video cameras inside the splicer capture the images of the two fibre ends and align the position of the fibres through a microprocessor. During splicing, the two fibres can be core-aligned or cladding-aligned depending on the settings chosen from the splice menu.



**Figure 38: Photograph Showing the Process of Core Alignment**  
 (The readings of 0.4° and 0.3° are the flatness of the fibre endfaces)  
 (Courtesy of Fujikura Ltd)

### Control of the Splicing Parameters and Conditions

Most modern splicers include pre-programmed procedures for splicing standard single-mode fibres, multi-mode fibres, dispersion-shifted fibres and polarisation-maintaining fibres. To splice special fibres, one may need to customise various splicing parameters such as the arcing time, arc current, gap distance, and so on. For instance, additional arcing is required when splicing an erbium-doped fibre to a standard telecommunication fibre to reduce the connection loss. This is because the erbium-doped fibre has a smaller mode-field diameter as compared to that of a regular telecommunication fibre.



**Figure 36: Fusion Splicing of an Erbium-doped Fibre to a Regular Fibre**

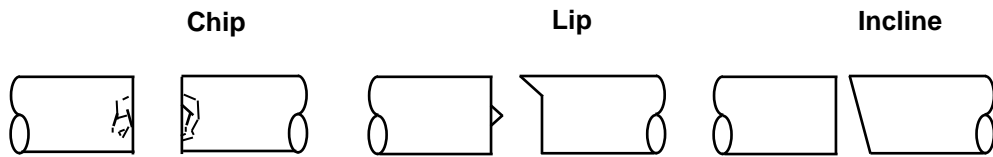
In single-mode fibres, the cores of the fibres are aligned by the splicer's built-in image processor before an electric arc is applied to fuse them together. Some splicers provide the option to allow the user to choose cladding alignment instead of core alignment. For polarisation-maintaining fibres, the Fast and Slow axes of the fibres are also rotated to align with each other before the core alignment process is carried out.

### Initiating the Splicing Process

When the splicing commences, the left and right fibres will move towards each other as the splicer attempts to align the fibres. Next, a cleaning arc is applied to the fibres to remove any dust particles, following which the cleave angle and the quality of the endface are checked. Upon detecting that the measured cleave angle is greater than the programmed threshold or a fibre chip is detected, an alarm will be triggered and an error message will be shown. The splicing procedure will then cease and manual intervention will be required.

The following endface conditions may result in a faulty splice, so even when there is no error discovered by the splicer, the fibres should be removed from the splicer for another cleaving process.



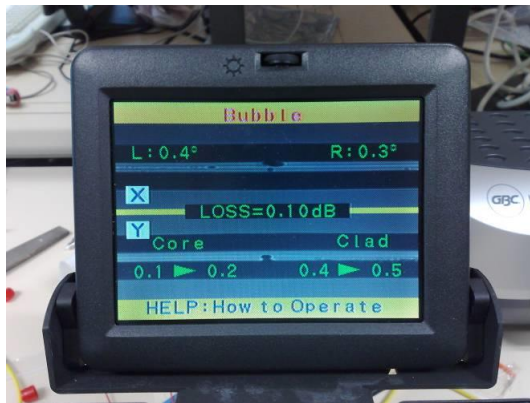


**Figure 37: Different Endface Conditions that will Cause a Faulty Splice (Courtesy Fujikura Ltd)**

**Proof-test**

The splicer has a built-in function to estimate the splice loss after the splicing operation is complete. Fusion splicing has minimal reflection loss and insertion loss, and usually insertion loss values in the range of 0.01dB to 0.15dB can be expected. Most modern splicers have the capability to conduct proof-test to test the strength of the splice joint. This amount of pull strength can be programmed by the operator.

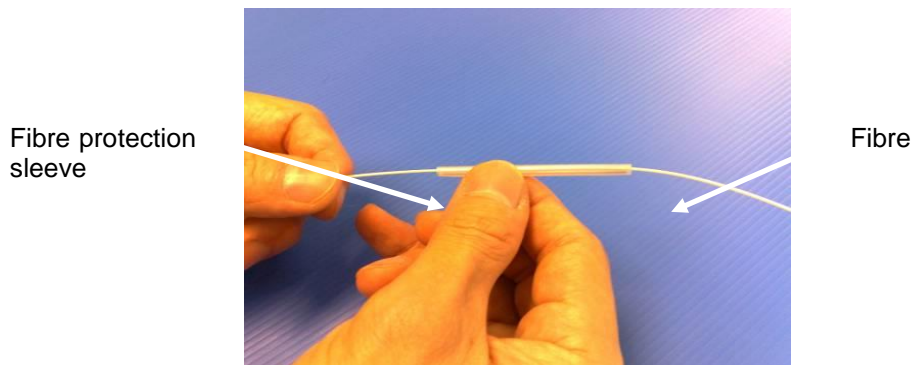
TIA/EIA-455-31-C or FOTP 31 describes the various methods for applying a specific tensile load to an optical fibre. This test will help in determining a minimum survivable strength for the optical fibre. This in turn will help in determining a minimum time of survival if the fibre experiences loads lower than the minimum survivable strength. This test is conducted using a series of motors and guide pulleys.



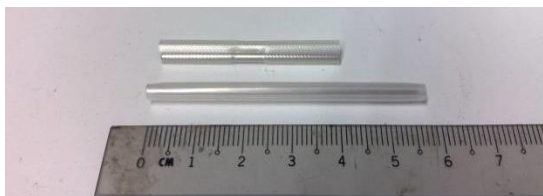
**Figure 38: The Fusion Splicer Estimates the Splice Loss (Courtesy of Fujikura Ltd)**

**Splice Protection**

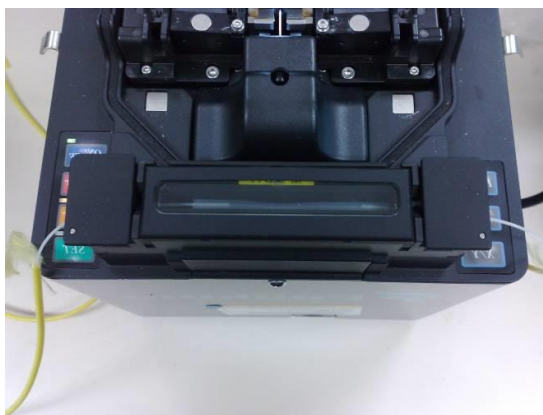
The spliced region is fragile and has to be protected by either recoating or with a splice protection sleeve so as to permanently protect the splice joints from breaking.



**Figure 39: A Protection Sleeve is Placed Over the Splice Joint after Splicing**



**Figure 40: Fibre Protection Sleeves of Various Lengths (60mm and 40mm are commonly used)**



**Figure 41: A Splice Protection Sleeve Heated up in the Heater (Courtesy of Fujikura Ltd)**



**Figure 42: A Splice Joint Protected by a 60mm Splice Protection Sleeve (Heat shrink tube)**

Another method of protecting the splice joint is by recoating whereby a specialised piece of equipment called a fibre recoater is used for coating the splice area. The recoating lengths are programmable from 4 to 50mm and the recoating time is 15 seconds for injection and another 15 seconds for curing. The advantage of recoating is that the splice joint is flexible, unlike the protection sleeve, which is rigid.

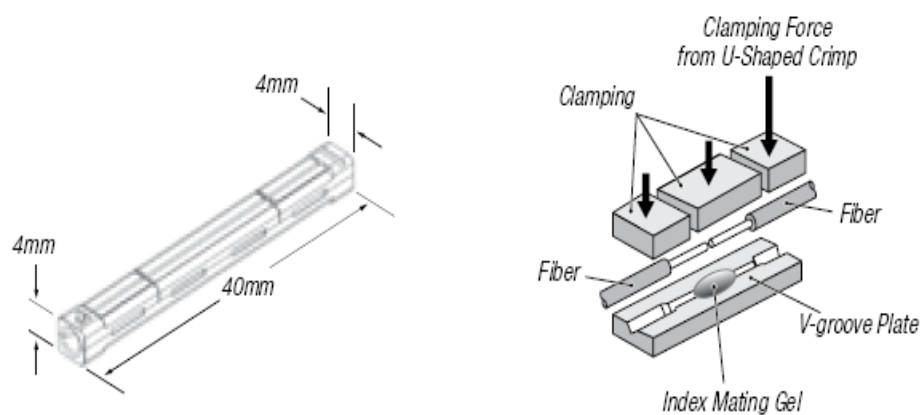
### **13 Mechanical Splice**

A mechanical splice is a self-contained mechanical assembly that aligns and joins two optical fibres together. The primary advantage is that the joints are not permanent and so they can be dismantled easily, unlike fusion-spliced joints. However, just as in fusion splicing, the ends of the two fibres have to be stripped, cleaved and cleaned before applying the mechanical splice.

To create a mechanical splice, the fibre ends are inserted into the splicing device where they are manually aligned by hand with the help of “V-grooves” that are present at each end of the device. When the endfaces make physical contact, the fibres are held in place by adhesives or a clamp. The photograph below shows a commercial mechanical splice tool.



**Figure 43: Mechanical Splice Tool**  
(Courtesy of Fujikura Ltd)



**Figure 44: Dimension and Structure**  
(Courtesy of Fujikura Ltd)

Mechanical splicing usually produces higher losses compared to fusion splicing. Typical insertion loss values range from 0.1 to 0.2dB while reflection loss varies from -45dB to -55dB. To reduce reflection loss, some mechanical splices are pre-loaded with an index-matching gel. For a more mechanically robust joint, some splicers use UV curable epoxy as an adhesive while others use a mechanical clamp to fix the fibre ends. A drawback of mechanical splicing is that it is relatively costlier than fusion splicing and, therefore, it is usually used for temporary repairs.

## 14 References

- [1] **TIA-598-C.** Optical Fibre Cable Color Coding. Jan 13, 2005.
- [2] **TIA-604-4-B.** FOCIS-4 Fibre Optic Connector Intermateability Standard, Type FC and FC-APC. Sep 9, 2004.
- [3] **IEC 61754-13.** Fibre Optic Connector Interfaces - Part 13: type FC-PC Connector - Edition 2.0. Feb 1, 2006.
- [4] **IEC 61754-20.** Fibre Optic Connector Interfaces - Part 20: Type LC Connector Family - First Edition. Aug 1, 2002.
- [5] **TIA-604-3-B.** FOCIS-3 Fibre Optic Connector Intermateability Standard, Type SC and SC-APC. Aug 31, 2004.
- [6] **ITU-T L.36.** Single-Mode Fibre Optic Connectors - Study Group 6. Jan 1, 2008.
- [7] **IEC 61300-3-7.** Fibre optic Interconnecting Devices and Passive Components - Basic Test and Measurement Procedures - Part 3-7: Examinations and Measurements - Wavelength Dependence of Attenuation and Return Loss of Single Mode Components - Edition 2.0. Jan 1, 2009.
- [8] **IEC 61300-3-6.** Fibre Optic Interconnecting Devices and Passive Components - Basic Test and Measurement Procedures - Part 3-6: Examinations and Measurements - Return Loss - Edition 3.0. Dec 1, 2008.
- [9] **IEC 60793-1-40.** Optical Fibres - Part 1-40: Measurement and Test Procedures - Attenuation- First Edition. Jul 1, 2001.
- [10] **TIA-455-107-A.** FOTP-107 Determination of Component Reflectance or Link/System Return Loss Using a Loss Test Set. Mar 1, 1999.
- [11] **IEC 61300-2-1.** Fibre Optic Interconnecting devices and passive components - Basic Test and Measurement Procedures - Part 2-1: Tests - Vibration (Sinusoidal) - Edition 3.01. Aug 1, 2009.
- [12] **IEC 61300-2-6.** Fibre Optic Interconnecting Devices and Passive Components - Basic Test and Measurement Procedures - Part 2-6: Tests - Tensile Strength of Coupling Mechanism - First Edition. Jan 1, 1995.
- [13] **IEC 61300-2-4.** Fibre Optic Interconnecting Devices and Passive Components - Basic Test and Measurement Procedure - Part 2-4: Tests - Fibre/Cable Retention - First Edition. May 1, 1995.
- [14] **IEC 61300-2-5.** Fibre Optic Interconnecting Devices and Passive Components - Basic Test and Measurement Procedures - Part 2-5: Tests - Torsion/Twist. Jan 29, 2003.
- [15] **IEC 61300-2-2.** Fibre Optic Interconnecting Devices and Passive Components - Basic Test and Measurement Procedures - Part 2-2: Tests - Mating Durability - Edition 3.0. Jan 1, 2009.
- [16] **IEC 61300-2-9.** Fibre Optic Interconnecting Devices and Passive Components - Basic Test and Measurement Procedures - Part 2-9: Tests - Shock - First Edition. Jun 1, 1995.
- [17] **IEC 61300-2-17.** Fibre Optic Interconnecting Devices and Passive Components Basic Test and Measurement Procedures Part 2-17: Test Cold - Second Edition. Feb 1, 2003.
- [18] **IEC 61300-2-18.** Fibre Optic Interconnecting Devices and Passive Components - Basic Test and Measurement Procedures - Part 2-18: Tests - Dry Heat - High Temperature and Endurance - Edition 2. Jul 1, 2005.
- [19] **IEC 61300-2-21.** Fibre Optic Interconnecting Devices and Passive Components - Basic Test and Measurement Procedures - Part 2-21: Tests - Composite Temperature/Humidity Cyclic Test - Edition 2.0. Dec 1, 2009.
- [20] **IEC 61300-2-22.** Fibre Optic Interconnecting Devices and Passive Components - Basic Test and Measurement Procedures - Part 2-22: Tests - Change of Temperature - Edition 2.0. Feb 1, 2007.
- [21] **IEC 61300-2-27.** Fibre Optic Interconnecting Devices and Passive Components - Basic Test and Measurement Procedures - Part 2-27: Tests - Dust - Laminar Flow - First Edition. Aug 1, 1995.
- [22] **IEC 61300-2-26.** Fibre Optic Interconnecting Devices and Passive Components - Basic Test and Measurement Procedures - Part 2-26: Tests - Salt Mist - Edition 2.0. Dec 1, 2006.
- [23] **IEC 61300-2-45.** Fibre Optic Interconnecting Devices and Passive Components - Basic Test and Measurement Procedures - Part 2-45: Tests - Durability Test by Water Immersion - First Edition. May 1, 1999.
- [24] **ITU-T L.12.** Optical Fibre Splices - Study Group 6. Mar 1, 2008.
- [25] **ITU-T G.652.** Characteristics of A Single-Mode Optical Fibre and Cable. JUN 1, 2005.
- [26] **ITU-T G.655.** Characteristics of A Non-Zero Dispersion-Shifted Single-Mode Optical Fibre and Cable - Study Group 15. Mar 1, 2006.

- [27] **ITU-T G.651.** Characteristics of a 50/125 Micrometer Multimode Graded Index Optical Fibre Cable - Series G: Transmission Systems and Media, Digital Systems and Networks - Transmission Media Characteristics - Optical Fibre Cables - Study Group15. Feb 1, 1998.

**Corrigendum / Addendum**

<b>Changes to IDA RD OFD - Part 3 Issue 1 Rev 1, May 2011</b>			
<b>Page</b>	<b>RS Ref</b>	<b>Items Changed</b>	<b>Date of Issue</b>
		The IDA RD OFD - Part 3 Issue 1 Rev 1 (May 2011) has been re-issued as the IMDA RD OFD - Part 3 Issue 1 (Oct 2016)	1 Oct 2016

<b>Changes to IDA RD OFD - Part 3 Issue 1, Jul 10</b>			
<b>Page</b>	<b>RS Ref.</b>	<b>Items Changed</b>	<b>Effective Date</b>
–	–	Change of IDA's address at cover page to Mapletree Business City.	1 May 11