

SCHEDULE 6
NUMBER PORTABILITY

**SCHEDULE 6
NUMBER PORTABILITY**

CONTENTS

| | | |
|------------------|---|-----------|
| 1. | GENERAL | 1 |
| 2. | DOCUMENTS FORMING PART OF SCHEDULE | 1 |
| 3. | PRINCIPLES FOR THE PROVISION OF NUMBER PORTABILITY SERVICES | 1 |
| 4. | PROCEDURES FOR THE PROVISION OF NUMBER PORTABILITY SERVICES | 2 |
| 5. | TRANSFER OF PORTED NUMBERS | 2 |
| 6. | CALLING LINE IDENTIFICATION | 3 |
| 7. | DISCUSSION OF TECHNICAL AND OPERATIONAL ISSUES | 3 |
| ANNEX 6A: | NUMBER PORTING PROCEDURES | 6 |
| ANNEX 6B: | PROVISION OF NUMBER PORTABILITY SERVICE PROCEDURE | 12 |
| ANNEX 6C: | TERMINATION OF NUMBER PORTABILITY SERVICE PROCEDURE | 13 |
| ANNEX 6D: | TERMINATION OF NUMBER PORTABILITY SERVICE WITH RNO RETURN TO DNO PROCEDURE | 14 |
| ANNEX 6E: | NUMBER PORTABILITY APPLICATION FORM | 15 |
| ANNEX 6F: | NUMBER PORTABILITY TERMINATION FORM | 16 |
| ANNEX 6G: | NUMBER PORTABILITY WITHDRAWAL REQUEST FORM | 17 |
| ANNEX 6H: | REJECTION CODES | 18 |
| ANNEX 6I | TECHNICAL SPECIFICATIONS | 19 |
| ANNEX 6J | NUMBER PORTABILITY CALL SCENARIOS | 24 |
| ANNEX 6K | BILLING VERIFICATION INFORMATION | 25 |
| ANNEX 6L | NUMBER PORTABILITY FORECASTING AND PROVISIONING PROCEDURE | 28 |

SCHEDULE 6

NUMBER PORTABILITY

1. GENERAL

- 1.1 This Schedule sets out the terms and conditions under which one Party, the Donor Network Operator (**DNO**), will provide the other Party, the Recipient Network Operator (**RNO**), with the Number Portability Service for the purpose of the RNO providing telecommunication services to Customers.

2. DOCUMENTS FORMING PART OF SCHEDULE

- 2.1 The following documents shall be deemed to be read and construed as part of this Schedule:

Annex 6A – Number Porting Procedures;

Annex 6B – Provision of Number Portability Service Procedure;

Annex 6C – Termination of Number Portability Service Procedure;

Annex 6D – Termination of Number Portability Service Procedure With RNO Return To DNO Procedure;

Annex 6E – Number Portability Application Form;

Annex 6F – Number Portability Termination Form;

Annex 6G – Number Portability Withdrawal Request Form;

Annex 6H – Rejection Codes;

Annex 6I – Technical Specifications;

Annex 6J – Number Portability Call Scenarios;

Annex 6K – Billing Verification Information; and

Annex 6L – Number Portability Forecasting and Provisioning Procedure.

- 2.2 The conditions of this Schedule shall prevail over the Annexes to this Schedule.

3. PRINCIPLES FOR THE PROVISION OF NUMBER PORTABILITY SERVICES

- 3.1 The Parties shall provide Number Portability Services using the Query on Release (**QoR**) method in accordance with the technical specifications set out in the Annexes.

3.2 Both Parties will cooperate to ensure smooth provisioning of Number Portability Services.

3.3 Neither Party shall recover set-up costs from the other Party in connection with the introduction of Number Portability, but other costs may be recovered as outlined in this Schedule and Schedule 9.

4. PROCEDURES FOR THE PROVISION OF NUMBER PORTABILITY SERVICES

4.1 Each Party shall provide to the other Party Forecasts in relation to the number of Ported Numbers in accordance with the procedures set out in Annex 6L.

4.2 The Parties shall process and execute the following applications for Number Portability Services as set out in Annexes 6A-6G:

- (a) Application for Number Portability;
- (b) Withdrawal of Application for Number Portability;
- (c) Termination of Number Portability; and
- (d) Applications from Customers for porting back of ported numbers.

5. TRANSFER OF PORTED NUMBERS

5.1 The DNO shall agree to the assignment or transfer of the rights or benefits in the subscription of a Ported Number (**transfer**) to another person(s) or company in the following circumstances provided always that at the time of the transfer the installation address of the Ported Number remains unchanged:

- (a) The line lessee or a person duly authorised to act on behalf of the line lessee wishes to transfer the Ported Number to an immediate family member or immediate family members (for joint-name cases). For the avoidance of doubt, “immediate family member” refers to spouse and siblings, parents and children; or
- (b) The company who had subscribed for the Ported Numbers wishes to transfer the Ported Number to a related company or associated company arising from a reconstruction or amalgamation; or
- (c) The line lessee or a person duly authorised to act on behalf of the line lessee wishes to transfer the ported telephone number to a person(s) with whom they are sharing accommodation. The person(s) to whom the ported telephone number is to be transferred shall furnish proof that they are sharing accommodation with the line lessee.

5.2 Where a Customer of the RNO wishes to transfer a Ported Number in accordance with clause 5.1, the RNO shall notify the DNO of such transfer and the RNO shall put the transfer into effect accordingly.

5.3 For the avoidance of doubt, nothing in this clause shall prohibit Number Portability in the event that a Customer merely changes its location.

6. CALLING LINE IDENTIFICATION

6.1 The RNO shall ensure that the original CLI settings of the ported number are maintained for Calls originated from the ported number in accordance with Annex 6I to correctly identify the ported number.

7. DISCUSSION OF TECHNICAL AND OPERATIONAL ISSUES

7.1 In the event of an issue arising in respect of any matter under this Schedule, either Party may notify the other in writing that it wishes to commence discussions to resolve the issue as provided in this clause 7.

7.2 Upon receipt by a Party of notice under clause 7.1, the Parties shall try to resolve the issue at an operational level. Any issues which remain unresolved after such attempt will be considered a dispute and may be referred by either party for Dispute Resolution in accordance with Schedule 11.

ANNEX 6A: NUMBER PORTING PROCEDURES

1. APPLICATION PROCEDURE FOR NUMBER PORTABILITY FOR FIXED NETWORK DIRECTORY NUMBERS OTHER THAN DID NUMBERS

1.1 Processing Procedure of RNO

1.1.1 The RNO shall initiate the porting of a Fixed Network Directory Number other than DID Numbers upon receipt of an NP Application Form for Number Porting from a Customer.

1.1.2 The RNO shall ensure that the NP Application Form contains the relevant information from the Customer including but not limited to the following:

- (i) Customer name;
- (ii) NRIC/BRN number;
- (iii) telephone installation address;
- (iv) authorised signature;
- (v) valid rubber stamp of Customer;
- (vi) designation of signatory;
- (vii) date and time of application;
- (viii) number to be ported;
- (ix) type of account (business/residential); and
- (x) date of Number Portability Service activation.

1.1.3 Annex 6E sets out the Number Portability Application Form which the Parties may present in their own format.

1.1.4 The RNO shall ensure that the information given by the Customer is true and correct.

1.1.5 The RNO may only submit the NP Application Form to the DNO if:

- (a) the number in question is not, at the time of application in the status of Temporary Disconnect, for whatever reason (including non-payment of outstanding amounts);

- (b) the Customer is the subscriber of the local telephone service associated with the number in question; and
- (c) the Customer has subscribed or is subscribing to the RNO for the provision of local telephone services associated with the number in question.

1.1.6 The RNO may only submit the NP Application Form to the DNO if, at the time of application, the number is associated with a working line in the DNO's Network.

1.1.7 The DNO will process up to twenty (20) numbers to be ported per Business Day (**Processing Date**). The RNO will send the Customer's signed NP Application Form to the DNO for processing. Such requests for Number Portability Service will be sent in two (2) batches daily through fax or any other means as subsequently agreed between the Parties. Each batch comprising NP Applications for Fixed Network Directory Numbers, (exclusive of DID Numbers), will contain up to a maximum of ten (10) numbers to be ported. The first batch will be sent before noon for response within the same Processing Date, whilst the second batch will be sent at the end of the Processing Date for response by noon of the next Processing Date.

SingTel Comment: Clause 1.1.7 of Annex 6A

The demand for this service has not been significant. Given the low level of demand for this service, SingTel considers that it is appropriate to reduce the maximum number of porting applications that it can be requested to process each day. This will enable SingTel to have resources available to perform this service that are more appropriate to the actual level of demand for this service. SingTel cannot reasonably be expected to have unlimited resources available when the demand is so low.

1.2 Processing Procedure of the DNO

1.2.1 Upon receipt of the NP Application Form submitted by the RNO, the DNO shall:

- (a) confirm that the Fixed Network Directory Number is associated with a Working Line;
- (b) confirm that the Fixed Network Directory Number is not in a Temporary Disconnect status at the date of receipt of the application;
- (c) confirm that the applicant is the line lessee of the local telephone service associated with the telephone number; and
- (d) verify that all the fields in the NP Application Form are duly completed and the NP Application Form signed by the line lessee.

1.2.2 Thereafter the DNO shall notify the RNO when it rejects the NP Application and such notice shall be given within two (2) Business Days of receipt of the NP Application.

SingTel Comment: Clause 1.2.2 of Annex 6A

To streamline this process, SingTel will only notify the RNO if its NP Application is rejected. If the NP Application is accepted, the porting process will simply continue. SingTel has extended the timeframe for notifications from 1 day to 2 days to enable SingTel to more efficiently allocate resources commensurate with the current low level of demand for this service.

1.2.3 Where the DNO accepts the NP Application, the DNO shall use its reasonable endeavours to activate the NP application within seven (7) Business Days of its acceptance of the NP Application.

SingTel Comment: Clause 1.2.3 of Annex 6A

This amendment allows more time for the RNO to make porting arrangements as well as to co-ordinate the activation of the service with the RNO's customers.

1.2.4 If the DNO receives more than 20 numbers in a single Processing Date from all the RNOs, the DNO will process the applications on a "first-come-first-served" basis to the first twenty (20) telephone numbers based on time of receipt of the NP Application forms. The rest of the numbers and applications will be processed on subsequent Processing Dates as if they had been received before the new applications received on that subsequent Processing Dates (ie applications not processed on one Processing Date will be carried over to subsequent Processing Dates).

SingTel Comment: Clause 1.2.4 of Annex 6A

These amendments align with SingTel's proposed amendments to clause 1.1.7 of Annex 6A.

1.3 Exceptions

1.3.1 The DNO may reject an NP Application if any information given is incorrect or missing, and in instances where the Number Portability request is declined, the DNO shall provide a rejection code for the rejection as listed in Annex 6H. The RNO will check the NP Application Form according to the rejection code provided by the DNO to ensure information completeness.

1.3.2 Where the NP Application Form has been previously rejected, the DNO shall process it in accordance with clause 1.2.4 of this Annex together with the next batch of forms.

1.4 Implementation

- 1.4.1 Upon confirmation by the DNO of the application, both Parties will update their respective network database with the routing information and carry out the necessary work as may be required in the agreed timescales as depicted in the Provision of Number Portability Service Procedure shown in Annex 6B.
- 1.4.2 The procedure for the processing and implementation of the Number Portability Service Procedure is as shown in Annex 6B.
- 1.4.3 The activation of the NP service will be carried out between midnight and 9.00 am of the 7th Business Day of the Processing Date.

SingTel Comment: Clause 1.4.3 of Annex 6A

To revise the time of activation consistent with the amendments proposed to clause 1.2.3 of Annex 6A. This will facilitate the parties' management of manpower to activate the request within a more practicable time period. It also facilitates faster investigation of faults should there be any at the point of activation of the Number Portability Service.

- 1.4.4 Once the above procedures have been carried out, the Number Portability Service for the said Customer will be in place and activated.
- 1.4.5 Once the Number Portability Service is activated, the RNO is responsible for performing its own testing. If there are problems that arise from the testing, the RNO shall work with the DNO to resolve the problems.

SingTel Comment: Clause 1.4.5 of Annex 6A

To clarify the RNO's responsibilities regarding testing once the Number Portability Service is activated.

2. TERMINATION OF NUMBER PORTABILITY SERVICE

2.1 Termination of Local Telephone Service

- 2.1.1 Where a Customer's local telephone service is terminated with the RNO, the RNO shall submit an NP Termination Form to the DNO seven (7) Business Days prior to the effective date of termination of the local telephone service. In the event that the Customer gives to RNO less than seven (7) Business Days' notice, the RNO will submit the NP Termination Form to the DNO on the same day it receives such notice from the Customer and the DNO will use its best endeavours to ensure that the Number Portability Service terminates on the same date as the termination of the Customer's local telephone service.
- 2.1.2 The NP Termination Form submitted by the RNO is provided in Annex 6F.

- 2.1.3 Within two (2) Business Days of the receipt of the NP Termination Form, the DNO shall notify the RNO if the NP Termination Request relates to a number which is not a Ported Number. The DNO will reject the application if it is not a Ported Number. In all other instances, the DNO shall proceed to initiate the termination of the Number Portability Services in accordance with the procedures set out herein and implement the termination at the earliest reasonable and possible time and in any event, no later than seven (7) Business Days from the receipt of request for termination.
- 2.1.4 Where Number Portability Service is terminated in accordance with this clause 2.1, the Ported Number shall be returned to the DNO on the date at which the termination is put into effect.
- 2.1.5 The DNO will inform the RNO of the effective date of termination and the Conveyance Charge for the provision of Number Portability services shall cease to apply on the same date.
- 2.1.6 The flowchart of this process is shown in Annex 6C.

2.2 Termination of Number Portability Service

- 2.2.1 Where a Customer chooses to terminate the Number Portability Service, the RNO shall inform the DNO of the termination by submitting a duly completed NP Termination Form set out in Annex 6F.
- 2.2.2 Within two (2) Business Days of the receipt of the NP Termination Form, the DNO shall notify the RNO if the NP Termination Request relates to a number which is not a Ported Number. The DNO will reject the application if it is not a Ported Number. In all other instances, the DNO shall proceed to initiate the termination of the Number Portability Services in accordance with the procedures set out herein and implement the termination at the earliest reasonable and possible time and in any event, no later than seven (7) Business Days from the receipt of request for termination.

SingTel Comment: Clause 2.1.1, 2.1.3 and 2.2.2 of Annex 6A

To be consistent with the amendments to NP Application timeframes and to allow SingTel to more appropriately allocate resources to this service commensurate with the current low level of demand. See comments in relation to clause 1.2.3 and 1.1.7 of Annex 6A above.

- 2.2.3 The DNO shall inform the RNO of the effective date of termination and the Conveyance Charge for the provision of Number Portability Services shall cease to apply on the same date.

2.2.4 Where a Number Portability Service is terminated in accordance with this clause, the Ported Number shall be returned to the DNO on the date at which the termination is put into effect.

2.2.5 The flowchart of this process is also shown in Annex 6C.

2.3 Termination of Number Portability Service with RNO and Return to DNO

2.3.1 Should a Customer request to port back to the DNO, an NP Application Form is required which may be in the Customers' own format but containing the information as shown in Annex 6E. This application will be deemed to be a new application for Number Portability Services and the procedures of clause 2 will apply save that the DNO will be the RNO for such application. The flowchart of this process is shown in Annex 6D.

3. WITHDRAWAL OF NUMBER PORTABILITY APPLICATION

3.1 Where, for whatever reason, prior to the implementation of the Number Portability Service, the RNO wishes to withdraw a successful NP Application, the RNO shall submit a NP Withdrawal Form no less than two (2) Business Days prior to the date the Number Portability Service is to be put into effect. The NP Withdrawal Form is to contain the information in Annex 6G.

3.2 Upon receipt of a NP Withdrawal Form, the DNO shall cancel the Number Portability Service activation. Any subsequent NP Application in respect to that Fixed Network Directory Number shall be subject to the standard porting procedures under clause 2 of this Annex 6A.

4. APPLICATION PROCEDURE FOR NUMBER PORTABILITY FOR DID NUMBERS

4.1 Processing Procedure of the RNO

4.1.1 DID and DDI Numbers shall be ported in blocks of one hundred (100) numbers or in the actual block size assigned to the Customer by the DNO.

4.1.2 Upon the receipt of a request of NP Services for DID Numbers from a Customer the DNO shall procure that the Customer completes an NP Application Form containing the information set out in Annex 6E.

4.1.3 The RNO shall ensure that the NP Application Form contains the relevant information from the Customer including but not limited to the following:

- (i) Customer name;

- (ii) NRIC/BRN number;
- (iii) telephone installation address;
- (iv) authorised signature;
- (v) valid rubber stamp of Customer;
- (vi) designation of signatory;
- (vii) date and time of application;
- (viii) number to be ported;
- (ix) type of account (business/residential); and
- (x) date of Number Portability Service activation.

4.1.4 Upon receipt of the NP Application Form from a Customer, the RNO must check with the Customer that the number to be ported is associated with a Working Service. The RNO must ask the Customer to verify that the NP Application Form is completed correctly and signed by a duly authorised person.

4.1.5 The RNO must ensure that the Customer who wishes to port DID numbers specifies the DID Numbers to be ported in the NP Application Form. The RNO will send the Customer's signed NP Application Form to the DNO for processing.

4.1.6 The NP Application Forms will be sent through fax or any other means as subsequently agreed between the Parties. Upon receipt of the NP Application Form, the DNO will revert to the RNO to acknowledge the receipt of the NP Application and to advise the date and time to activate Number Portability Service. The timeframe for porting of DID numbers in blocks of one hundred (100) numbers is, unless agreed otherwise by the Parties, as defined below:

| Project size | Number of Business Days |
|------------------------|---|
| Less than 500 numbers | ten (10) or less Business Days |
| 500 to 1000 numbers | twelve (12) Business Days |
| More than 1000 numbers | eighteen (18) Business Days or any other duration to be mutually agreed by the Parties. |

4.1.7 The DNO shall implement a minimum of one (1) project per Business Day (ie including total applications for Number Portability for DID and DDI numbers). The

DNO will use its reasonable endeavours to implement up to five (5) projects per Business Day subject to the timeframe specified in clause 4.1.6 above, but is under no obligation to implement more than one (1) project per Business Day.

5. TERMINATION OF DID SERVICE

5.1 Termination of Line/Number Portability Service

- 5.1.1 Where a Customer chooses to terminate the DID subscription or Number Portability Service, the RNO shall inform the DNO of the termination through an NP Termination Form in accordance with Annex 6E. The termination of Number Portability Service will be effected within seven (7) Business Days from the receipt of the notification. The DID numbers will be returned to DNO upon the termination of Number Portability Service.

SingTel Comment: Clause 5.1.1 of Annex 6A

See comments in relation to clause 1.2.3 of Annex 6A above.

5.2 Termination of Number Portability Service with RNO and Return to DNO

- 5.2.1 Should a Customer request to port back to the DNO, an NP Application Form is required to be forwarded to the DNO. This application will be deemed to be a new Number Portability Application and the procedures in clause 4 will apply save that the DNO will be in the position of the RNO. The flowchart of this process is shown in Annex 6D.

ANNEX 6B: PROVISION OF NUMBER PORTABILITY SERVICE PROCEDURE

RECIPIENT NETWORK

Registration

- Customer registers for Number Portability Service
- Process application
- Send notification with all the required information (see attached) to donor
- Acknowledgement received

Preparation

- Jobs for the provision of NP
- Receive activation date and time from Donor
- Inform Customer service activation date
- Updating of SCP

Implementation

- Activate Customer line
- Conduct testings

DONOR NETWORK

Registration

- Receive notification from recipient
- Acknowledgement of NP request
- Verify Customer records and check telephone status
- Jobs for the provision of NP

Preparation

- Send scheduled NP activation date and time to recipient
- Updating of SCP
- Verify and update Customer data at switch, Customer data at OSS, update fault report system, etc
- Prepare NP marking (CV#14) for affected Customers

Implementation

- Activate CV#14 on scheduled time Customer line

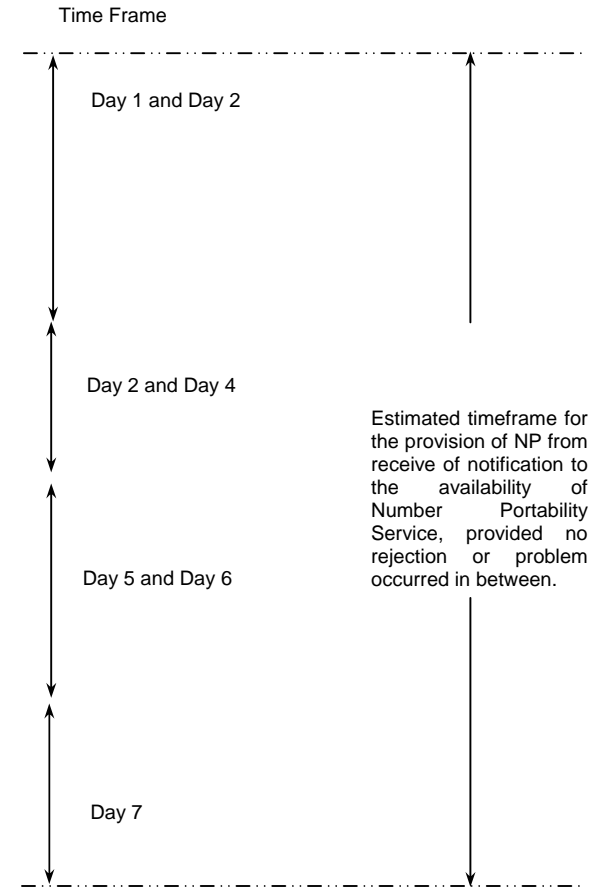

The above timeframe is subject to the following conditions:

- a) Applicable to Fixed Network Directory Numbers other than DID which will be on project basis;
- b) Maximum of 100 ported numbers will be processed in a Business Day.

ANNEX 6C: TERMINATION OF NUMBER PORTABILITY SERVICE PROCEDURE

RECIPIENT NETWORK

DONOR NETWORK

Registration

Registration

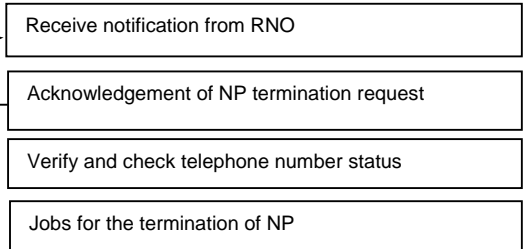
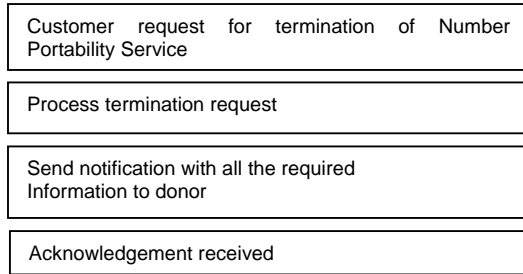

Preparation

Preparation

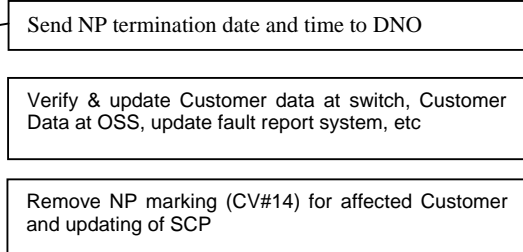
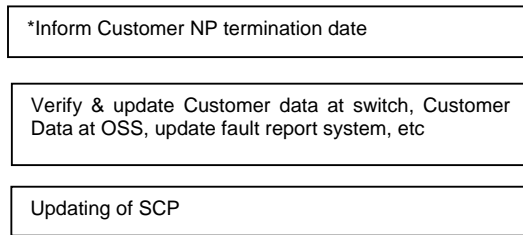

Implementation

Implementation

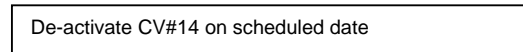
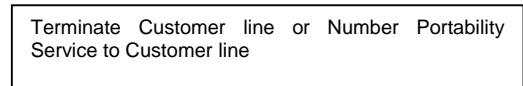

Time Frame

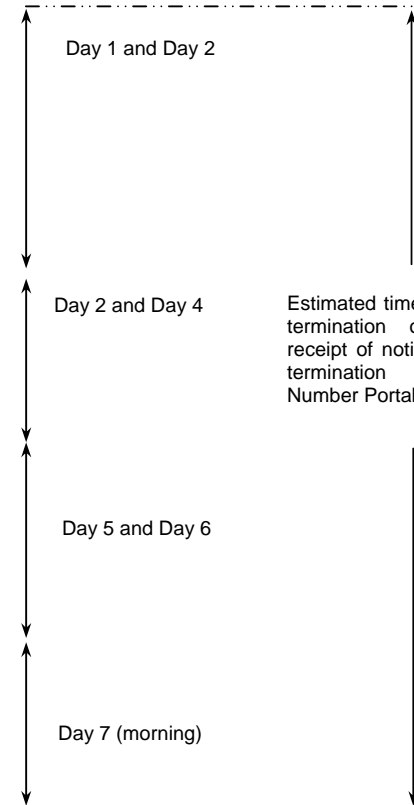

Estimated timeframe for the termination of NP from receipt of notification to the termination of NP of Number Portability Service.

*if applicable

ANNEX 6D: TERMINATION OF NUMBER PORTABILITY SERVICE WITH RNO RETURN TO DNO PROCEDURE

ORIGINAL DONOR NETWORK

ORIGINAL RECIPIENT NETWORK

Registration

Registration

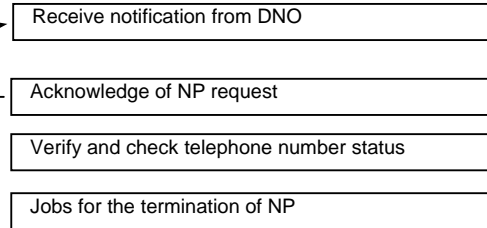
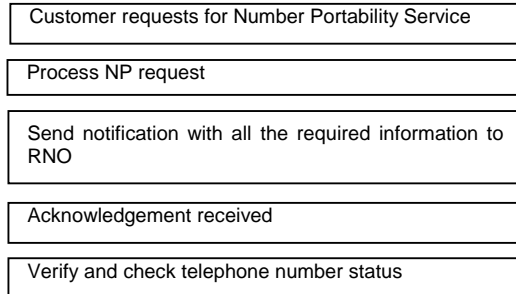

Preparation

Preparation

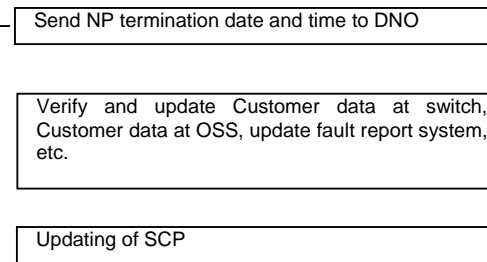
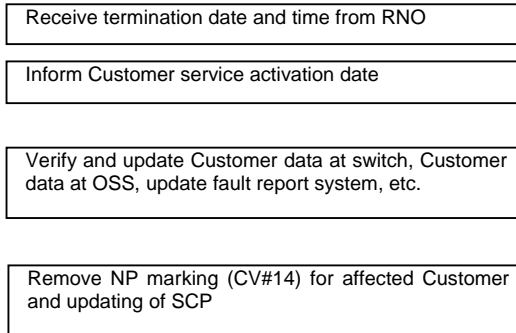

Implementation

Implementation

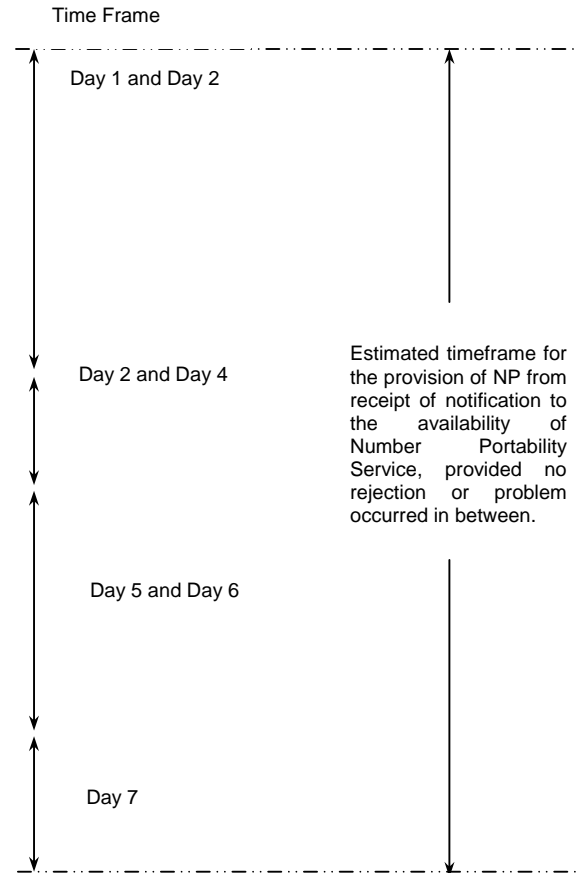
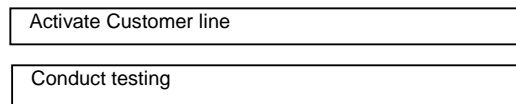

ANNEX 6E: NUMBER PORTABILITY APPLICATION FORM

Logo

DRAFT COPY

Contact Numbers:
 Residential : 1609 (Toll-free) Fax: 738 2077
 Business: 1606 (Toll-free) Fax: 737 5151

Application For Number Portability for Local Telephone Service(s)

- Notes:
1. Please bring along the following original document together with this application form, duly completed, for verification.
 - (a) NRIC or passport for application under Personal Basis.
 - (b) Business Registration Certificate or Certificate of Incorporation, as the case may be, for application under name of Firm or Company.
 - (c) Work Permit or Employment Pass for non-citizen applicants.
 2. Please allow at least seven (7) Business days for the services to be effected.
 3. For subscription by a Firm / Company, this application should be made by an authorised officer of the Firm / Company.
 4. The telephone number(s) must be on "working" status on the effective date of porting i.e that shall have been no disconnection of service whether permanent or temporary.

| | |
|--|--|
| On Personal Basis | On Behalf Of Firm/Company |
| Name Of Applicant (in block letters & underline surname) Mr / Miss / Mrs / Mdm / Dr | Name of * Firm/Company |
| * NRIC / Passport No. | * Certificate Of Incorporation / Business Registration No. |

Installation Address

Postal Code

Correspondence Address (if different from installation address)

Postal Code

For Clarification, Please Contact (optional)

Name: _____ Telephone No: _____ Fax No: _____ * Pager / Mobile Phone No: _____

Local Telephone/ Service to be ported(if space is insufficient, please use supplementary sheets)

| | |
|--|--|
| <p>List of Local Telephone Number(s) to be ported to [insert name of RNO]'s telephone network from</p> <p>1.....</p> <p>2.....</p> <p>3.....</p> <p>4.....</p> <p>5.....</p> <p>6.....</p> | <p>For Official Use (RNO to enter N2 numbers for each N1 numbers)</p> <p>1.....</p> <p>2.....</p> <p>3.....</p> <p>4.....</p> <p>5.....</p> <p>6.....</p> |
|--|--|

Terms And Conditions

*I/We agree that [Licensee] and [Licensee] will not be responsible for losses or service interruptions arising from the termination of services and/or porting of Local in relation to the above Local Telephone number(s) and/or porting of Local Telephone number(s).

*I/We shall be responsible to [Licensee] for all charges incurred up to the date and time the Local Telephone Number(s) is/are ported to [Licensee].

*I/We shall settle all outstanding charges with [Licensee] within 14 days from the date of [Licensee]'s bill.

*I/We hereby authorize [Licensee] to request that my/our existing number(s) as noted above be ported or transferred from a [Licensee] service to my/our [Licensee] service, and to carry out any other necessary steps on my/our behalf so that I/we can continue to use the same number(s) with effect from the date noted on this form.

**I/We agree that as of the date the Local Telephone Service(s) is/are ported to [Licensee], the existing Terms and Conditions for Telephone Service (in the latest version of the Singapore Phone Book Business Listings) shall, in respect of such Local Telephone Service(s) ported to [Licensee], bind me/us.

*I acknowledge and agree that the porting will result in the disconnection of the Local Telephone Service(s) from [Licensee] and finalisation of the [Licensee] account(s) for the Local Telephone Service(s).

*I/We confirm that the above information as given is true and correct.

*I certify that I have the authority as the Customer or as the authorised officer for the Customer of the Local Telephone Service(s) listed on this form to request porting of the Local Telephone Service(s) stated above.

Signature Of *Applicant/Authorised Officer & Date Name and Designation of Signatory Company Stamp (if applicable)

For Official Use Only

| | | |
|--|--|--------------------------------------|
| Document Submitted By (name & NRIC/passport no.) | Documents Checked & Verified By (name & date). | Faxed On Serial No. |
| | | <input type="text"/> p.m. activation |

Txx * Please delete whichever is inapplicable MM/Y

ANNEX 6F: NUMBER PORTABILITY TERMINATION FORM

[RNO's corporate logo]

[Date]

[From RNO]

[To DNO]

REQUEST FOR TERMINATION OF NUMBER PORTABILITY SERVICE

We hereby request the termination of Number Portability Service to the following telephone numbers:

| <u>S/No.</u> | <u>Telephone Number</u> | <u>Original Date for NP Activation</u> | <u>Requested Termination Date</u> |
|--------------|-------------------------|--|---------------------------------------|
| 1. | | | |
| 2. | | | |
| 3. | | | |
| 4. | | | |
| 5. | | | |

Yours sincerely,

[Authorised Officer from RNO]

ANNEX 6G: NUMBER PORTABILITY WITHDRAWAL REQUEST FORM

[RNO's corporate logo]

[Date]

[From RNO]

[To DNO]

REQUEST FOR WITHDRAWAL OF NUMBER PORTABILITY APPLICATION

We hereby request the withdrawal of the following applications for Number Portability Service which was earlier sent to [DNO]:

| <u>S/No.</u> | <u>Telephone Number</u> | <u>Date of NP Application</u> |
|--------------|-------------------------|-------------------------------|
|--------------|-------------------------|-------------------------------|

- 1.
- 2.
- 3.
- 4.
- 5.

Yours sincerely,

[Authorised Officer from RNO]

ANNEX 6H: REJECTION CODES

The following Rejection Codes shall be used when the DNO declines the NP Application Forms:

- 001 - Information incomplete.
- 002 - Information incorrect.
- 003 - Form not duly signed.
- 004 - Form not signed by applicant/authorised personnel.
- 005 - Number not allocated.
- 006 - Line not on working status.
- 007 - Less than seven (7) Business Days given for DEL numbers.
- 008 - Less than the agreed number of days given for DID.
- 009 - Routing number not available or incorrect.
- 010 - Application exceeds maximum number per day

ANNEX 6I TECHNICAL SPECIFICATIONS

1. SIGNALLING REQUIREMENT

1.1 General Description

1.1.1 In a Network where Number Portability is offered, a ported Customer has two numbers used by the Network to reach the Customer: the Fixed Network Directory Number (**N1**), which represents the logical identity of the user itself, and the Routing Number (**N2**) that is used to route the Call towards the Customer when Called which represents the “physical” identity of the user.

1.1.2 For a ported user originating a Call, the transfer of both N1 and N2 is useful for security services based on the logical identity and the physical location of the Calling user. A new ISUP parameter (**ACLI**) is defined under national option to convey the second identity of a Calling user across the Network.

1.1.3 The Originating Network must deliver the following information to the Recipient Network in the Call path, once the routing information has been obtained:

- (a) the Routing Number; and
- (b) the ACLI.

1.1.4 The Number Portability method to be adopted shall be QoR.

1.1.5 To support QoR, there is a requirement as a Network option to indicate in the backward direction (ie from the Donor Network/Exchange to the Originating Network) that the dialled number has been ported out. The Donor Network shall send a Release Message with a specific cause value to the Originating Network. The Originating Network shall query the Database for the Routing Number and route the Call to the Recipient Network.

1.2 Technical Specifications of Number Portability

1.2.1 Type of Addressing

The Routing Number (**N2**) from the query shall be in the Called Party number parameter of the IAM message to route the Call to the Recipient Exchange.

1.2.2 Cause Value

The cause value for QoR shall be ‘0001110’ or 14 (QoR: ported number). The format shall be in accordance with Q.850 with the coding standard sub-field coded as depicted below:

Coding standard

Bits 7 6
 0 0 ITU-T standardised coding

1.2.3 ACLI

A new ISUP parameter is defined under national option to carry the actual Calling Party number of the ported Customer (N2) in the IAM message across the Network.

The ACLI parameter shall be coded as '11111010' and format shall be in accordance with the Calling Party number parameter as defined in ITU-T Q.763. The presentation indicator shall be coded as 'presentation restricted'. The format is shown below:

| | 8 | 7 | 6 | 5 | 4 | 3 | 2 | 1 |
|---|-----------------------|-----------------------------|---|---|--------------------|---|-----------|---|
| 1 | Odd/ even | Nature of address indicator | | | | | | |
| 2 | NI | Numbering plan Ind. | | | Present. Ind. | | Screening | |
| 3 | 2nd address signal | | | | 1st address signal | | | |
| . | | | | | | | | |
| . | | | | | | | | |
| n | Filler (if necessary) | | | | nth address signal | | | |

Note - When the address presentation restricted indicator indicates address not available, octet 3 to n are omitted.

Additional CLI parameter field

The following codes are used in the sub-fields of the new parameter.

a) Odd/even indicator

(See Q.763, 3.9a)

b) Nature of address indicator

| | |
|---------------|--|
| 0 0 0 0 0 0 0 | spare |
| 0 0 0 0 0 0 1 | Customer number (national use) |
| 0 0 0 0 0 1 0 | unknown (national use) |
| 0 0 0 0 0 1 1 | national (significant) number (national use) |
| 0 0 0 0 1 0 0 | international number |
| 0 0 0 0 1 0 1 | } spare |
| to | |
| 1 1 0 1 1 1 1 | } reserved for national use |
| 1 1 1 0 0 0 0 | |
| to | |
| 1 1 1 1 1 1 0 | } spare |
| 1 1 1 1 1 1 1 | |

c) Calling Party number incomplete indicator (NI)

0 complete
1 incomplete

d) Numbering plan indicator

(See Q.763, 3.9d)

e) Address presentation restricted indicator

0 0 presentation allowed
0 1 presentation restricted
1 0 address not available (Note) (national use)
1 1 spare

NOTE – When the address is unavailable, the subfields in item a), b) c) and d) are coded with 0's.

f) Screening indicator

0 0 reserved (Note)
0 1 user provided, verified and passed
1 0 reserved (Note)
1 1 network provided

NOTE – Code 00 and 10 are reserved for "user provided, not verified" and "user provided, verified and failed" respectively. Codes 00 and 10 are for national use.

g) Address signal

0 0 0 0 Digit 0
0 0 0 1 digit 1
0 0 1 0 digit 2
0 0 1 1 digit 3
0 1 0 0 digit 4
0 1 0 1 digit 5
0 1 1 0 digit 6
0 1 1 1 digit 7
1 0 0 0 digit 8
1 0 0 1 digit 9
1 0 1 0 Spare
1 0 1 1 code 11
1 1 0 0 code 12
1 1 0 1 }
to } spare
1 1 1 1 }

h) Filler (See Q.763, 3.9f)

1.3 Signaling Requirement Information Flow

1.3.1 Call Origination from a Ported-in Customer

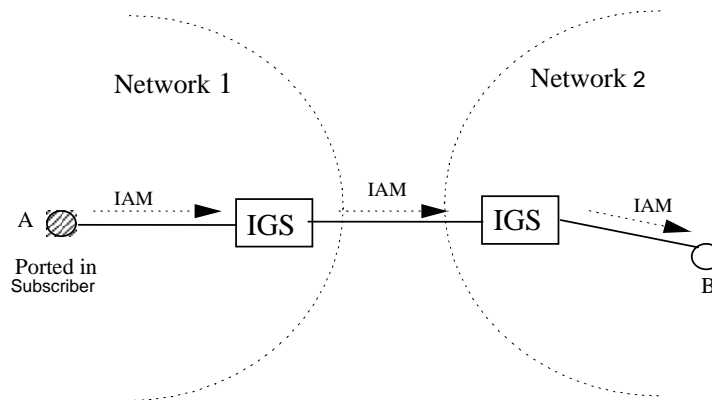

- **New ISUP Parameter : Additional Calling Party Identification**

ISUP IAM

Called Party number = DNB

Calling Party number = DNA (N1)

Additional CLI = RNA (N2)

DN: Fixed Network Directory Number

RN: Routing Number

1.3.2 Call Terminated to a Ported Customer

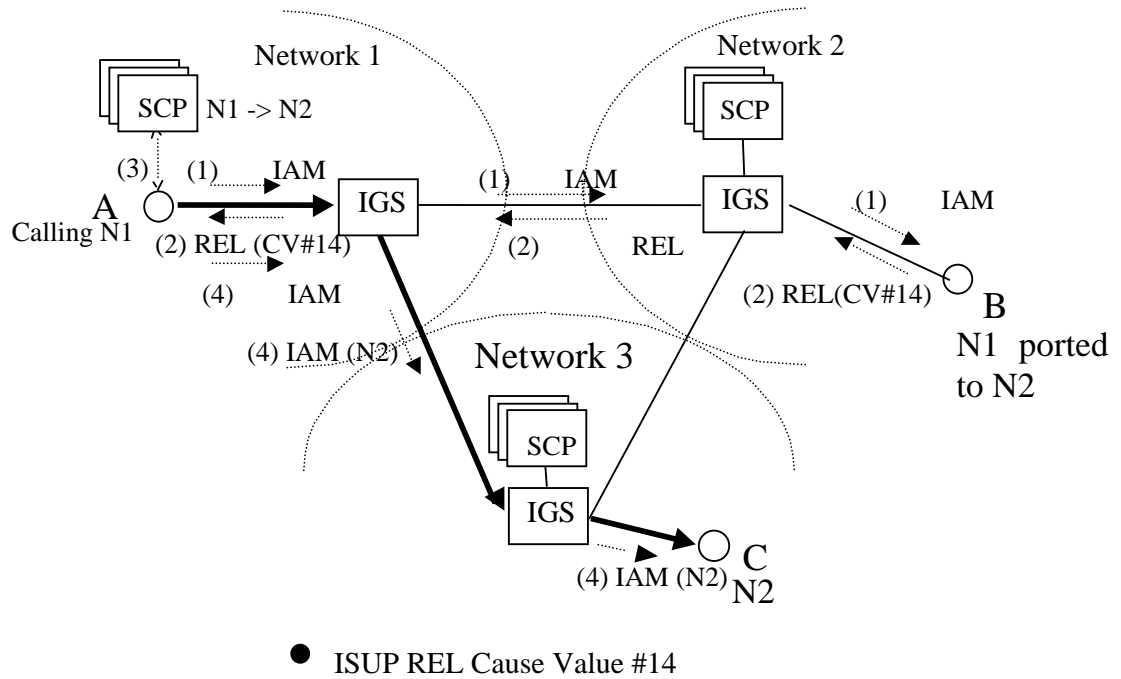

Information Flow (1) IAM

Called Party Number = DNB (N1)

Calling Party Number = DNA

Information Flow (2) ISUP

Cause Value (CV) = 14

Information Flow (4)

Called Party Number = RNC (N2)

Calling Party Number = DNA

DN: Directory Number

RN: Routing Number

ANNEX 6J NUMBER PORTABILITY CALL SCENARIOS

1. Call Scenario for DEL and DID

1.1 Call Originated from a Ported-in Customer

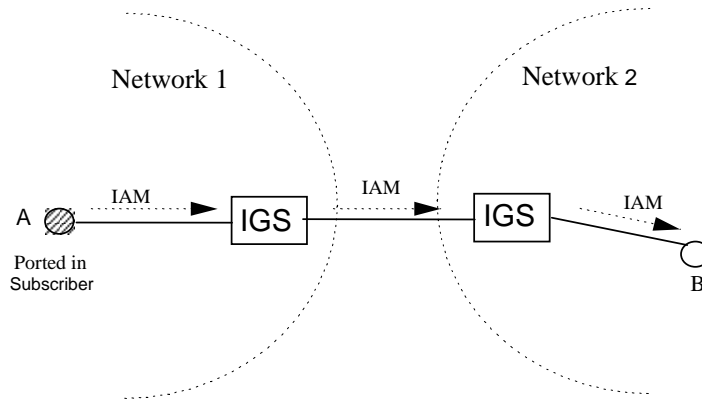

- **New ISUP Parameter : Additional Calling Party Identification**

1.2 Call Terminated to a Ported Customer

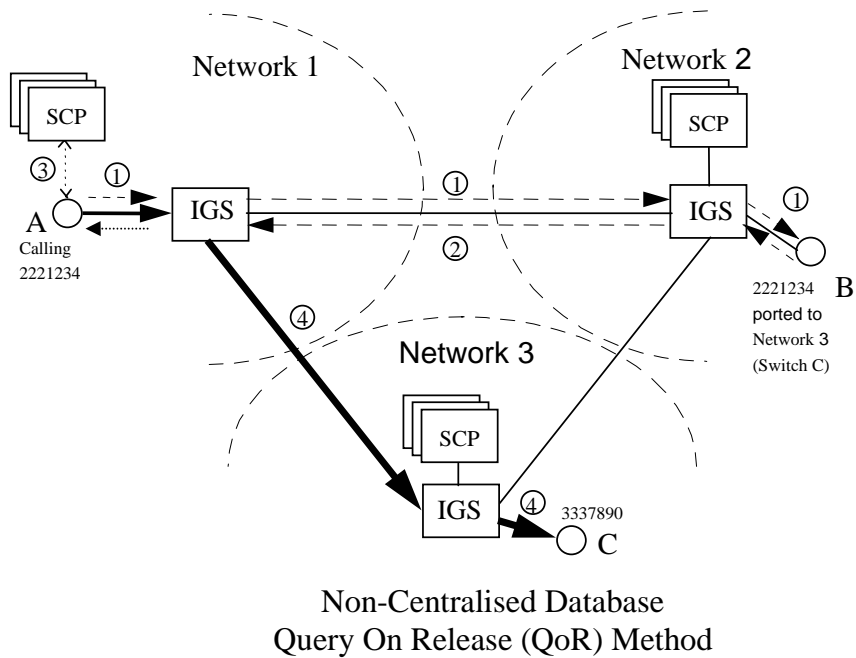

ANNEX 6K BILLING VERIFICATION INFORMATION

1. BILLING VERIFICATION INFORMATION (BVI)

- 1.1 The Parties shall provide BVI for the Administration Charges for the Number Portability Service in accordance with the format set out in Annex 6K.
- 1.2 The Parties shall provide BVI for the Conveyance Charges for the Number Portability Service in accordance with the format set out in Annex 6K.
- 1.3 The Parties shall provide the BVI for Number Portability Service together with the invoice to be issued within fourteen (14) Calendar Days from end of each billing period.

2. BILLING REPRESENTATIVES

- 2.1 Subject to clause 4.2, enquiries relating to billing, collecting and settlement arrangements or in relation to Network and operation issues may be directed to the nominated Billing Representatives listed in Schedule 10.

Annex 6K: Billing Verification Information for Administration Charges for Number Portability Service

Billing Period: From _____ to _____.

| Description | Application Date | Fixed Network Directory Number | Amount |
|---|------------------|--------------------------------|--------|
| 1. Application for NP Service | | | |
| 2. Application for Termination of NP Service | | | |
| 3. Withdrawal of application for NP Service | | | |
| 4. Application for termination of NP Service with port back to original DNO | | | |

Annex 6K: Billing Verification Information for Conveyance Charges for Number Portability Service

1. Billing Period: From _____ to _____.
2. Number of IN dips made in Billing Period.

| List of Ported Numbers | Number of IN dips made |
|-------------------------------|------------------------|
| Ported Number [Reference No.] | |
| Grand Total | |

ANNEX 6L NUMBER PORTABILITY FORECASTING AND PROVISIONING PROCEDURE

1. General

1.1 This Annex 6L sets out the Forecasting and provisioning procedures for the provisioning of each Party’s Network for Number Portability Services.

2. Forecasting and Provisioning of Capacity

2.1 The RNO shall provide to the DNO Forecasts for Number Portability on or near 1 March and 1 September of each year. The Forecasts shall include the number of Fixed Network Directory Numbers which will be ported. The Forecasts shall be for periods commencing six (6) months from 1 March and 1 September (**Forecast Date**) respectively, and be for a period of thirty-six (36) months, in intervals of six (6) months for the first twelve (12) months, and yearly thereafter.

2.2 The Forecast shall be in the format as follows. Three-year Forecasts provided by Licensees on a quarterly basis expressed in numbers of Fixed Network Directory Numbers:

| Forecasting Period | Date | Total |
|--|-------------|--------------|
| Capacity Commitment for 1 st Quarter ending | | |
| Forecast for 2 nd Quarter ending | | |
| Forecast for 3 rd Quarter ending | | |
| Forecast for 4 th Quarter ending | | |
| | | |
| Forecast for 2 nd Year ending | | |
| Forecast for 3 rd Year ending | | |

2.3 Each Party shall provide the Forecasts in good faith and use all reasonable endeavours to ensure that Forecasts are accurate.

2.4 The DNO will respond in writing to the RNO upon receipt of a Forecast within fifteen (15) Business Days, or such other number of days mutually agreed, from the date of receipt. The response shall be either:

- (a) an acknowledgement that the DNO agrees to the Forecast and is able to comply with the Forecast for the first year; or

- (b) a request in accordance with clause 2.5 below, to have a meeting to clarify/discuss the Forecast where the DNO considers that the Forecast is unreasonable.
- 2.5 Where the DNO considers that the Forecast is unreasonable, on account of the response given under clause 2.4(b), the DNO shall provide reasons in writing to support its views. The Licensees shall promptly negotiate in good faith any adjustment to the Forecast. Should the Licensees fail to agree on a revised Forecast within twenty five (25) Business Days of receipt of the Forecast, the Forecast of the RNO (subject to any reduction agreed to by the RNO in the course of the clarification/discussion) shall be accepted by the DNO for the purposes hereof. To assist the clarification/discussion:
 - (a) each Party shall provide information upon which its assessment of the reasonableness (or otherwise) of the Forecast is based provided that nothing herein shall require any Party to provide information which it deems to be commercially sensitive or confidential; and
 - (b) each Party shall endeavour to put forward proposals to produce a satisfactory outcome for both Parties.
- 2.6 Subject to clause 4 and save for clause 2.1, the Licensees agree that the Capacity for the first quarter of the first year of each Forecast is: -
 - (a) agreed to by the DNO in accordance with clauses 2.4(a); or
 - (b) accepted by the DNO following the outcome of the clarification/discussion provided for in clause 2.5.
- 2.7 Each Party shall ensure that its Network is provisioned and maintained in a manner to enable it to meet the Capacity Commitment.
- 3. Variation of Forecasts**
- 3.1 If the RNO seeks Capacity at a level other than the Capacity Commitment or on an earlier delivery date other than the Capacity Commitment delivery date, it may make a request to the DNO in writing.
- 3.2 The DNO shall be entitled to recover all reasonable administrative and expediting costs for providing such requested capacity from the RNO and shall inform the RNO of such costs as soon as possible.
- 3.3 Where such costs are accepted by the RNO, the DNO shall provide the RNO the requested capacity in no longer than a six (6) month timeframe.

4. Delivery of Capacity Commitment

4.1 Where the DNO fails or has any reason to believe that it is likely to fail to meet a Forecast, it shall forthwith notify the RNO in writing stating (where applicable):

- (i) the reason for the failure or likely failure;
- (ii) the Capacity it fails or is likely to fail to provide; and
- (iii) the Forecast delivery time it fails or is likely to fail to meet.

4.2 Both Parties shall forthwith negotiate in good faith to arrive at a solution to best address the Capacity requirements and delivery times of the RNO as set out in the Forecast provided nothing herein shall excuse the DNO from its failure to meet the Forecast unless:

- (i) the actual Capacity provided by the DNO is not less than eighty percent (80%) of the Capacity Commitment; and
- (ii) the actual delivery time is not later than two (2) months from the date of the Forecast delivery time for the Capacity Commitment.

5. Recovery for Over Forecasting

5.1 The DNO shall be able to recover all the cost incurred as a result of over Forecasting by the RNO.

5.2 Where Capacity in addition to that requested in the initial Forecast is sought to be provided for the first year, the DNO shall be entitled to recover the costs incurred in providing the additional Capacity in the first year from the RNO that is not eventually used at the end of the first year. The DNO has no obligation to provide Capacity in addition to the Committed Forecast.

5.3 The Parties agree, in the first quarter of 2001, to negotiate in good faith provisions for the recovery of reasonable cost incurred as a result of over Forecasting to take effect from the second quarter of 2001. Provided that if the Parties shall fail to agree on such provisions, the Parties shall submit the matter to the Authority for determination.

5.4 If the actual number of telephone numbers ported into the RNO's Network is greater than or equal to eighty percent (80%) of its Capacity Commitment, no Charges shall apply.

5.5 If the actual number of telephone numbers ported into the RNO's Network is less than eighty percent (80%) of its Capacity Commitment, the RNO shall pay to the DNO the Charges listed in Schedule 9.