

TELECOMMUNICATIONS ACT (CHAPTER 323)

CODE OF PRACTICE FOR INFO-COMMUNICATION FACILITIES IN BUILDINGS [Year]

In exercise of the powers conferred by section 19(1) of the Telecommunications Act (Cap. 323), the Info-communications Media Development Authority issues the following Code of Practice:

CHAPTER 1 PRELIMINARY

1.1 Citation and commencement

This Code may be cited as the Code of Practice for Info-communication Facilities in Buildings [Year] and shall come into operation on [Date].

1.2 Definitions

In this Code, unless the context otherwise requires –

“building” means any permanent building or structure;

“cable” means a cable, wire or line used or intended to be used for telecommunications;

“cable distribution system” means a network of cable trays, cable ladders, trunking, conduits and underfloor ducts, which enables cables to be laid from one point to another point within a building or a development;

“certificate of statutory completion” has the same meaning as in the Building Control Act (Cap. 29);

“coaxial cable” means a coaxial cable that is used for the distribution of television and the Internet to an end user;

“common property” has the same meaning as in section 2(1) of the Building Maintenance and Strata Management Act (Cap. 30C);

“construction” in relation to a building, means the erection, extension of, alteration and/or addition to the building, and “construct” and “constructed” shall be construed accordingly;

“development” means a single project (whether completed or not) consisting of 1 or more buildings, and includes all parcels of land comprised within the same project;

“Effective Date” means the date this Code comes into operation;

“Gross Floor Area” is calculated using the definition by the Urban Redevelopment Authority;

“Housing and Development Board” means the Housing and Development Board established by section 3 of the Housing and Development Act (Cap. 129);

“IMDA” means the Info-communications Media Development Authority constituted under the Info-communications Media Development Authority Act 2016 (No. 22 of 2016);

“installation, plant or system” includes all structures, machinery, equipment, cables, poles and lines used or intended for use in connection with telecommunications;

“landed dwelling-house” means any of the following types of houses used wholly or mainly for the purpose of human habitation –

- (a) detached house;
- (b) semi-detached house; or
- (c) terrace house

but does not include a strata landed dwelling-house;

“lead-in pipes” in relation to –

- (a) a landed dwelling-house, means the pipes which extend outwards from the boundary of the house to enable the laying of cables from outside the property into the property; and
- (b) a development consisting of a building or buildings other than landed dwelling-houses, means the pipes which extend outwards from the boundary of the development to enable the laying of cables from outside the development into the development;

“licensee” means a telecommunication system licensee as defined in section 2 of the Telecommunications Act;

“main distribution frame room” means a room within a building or development that is used to house a main distribution frame and licensees’ installation, plant or systems;

“mixed-use building” means a building used for both residential and non-residential purposes;

“mobile coverage area” refers to any area within a development which is to be served by any public cellular mobile telecommunication system and shall comprise –

- (a) the total Gross Floor Area (GFA) of all buildings within the development; and

- (b) all other areas within the boundary of the development, covered or uncovered, at which an end user of public cellular mobile telecommunication services may reasonably expect to have access to such services, including but not limited to lift lobbies, walkways, pavilions, playgrounds and open-air carparks;

“mobile deployment space” means the space to be set aside by the developer or owner for the deployment of installation, plant or systems by mobile telecommunication licensees;

“mobile telecommunication licensee” means a person that has been granted a licence by IMDA to establish, install, operate and maintain telecommunication systems for the provision of public cellular mobile telecommunication services;

“multi-storey residential building” means a residential building, other than a landed dwelling-house or strata landed dwelling-houses, consisting of two or more storeys used wholly or mainly for the purpose of human habitation;

“non-residential building” means a building used for any non-residential purpose and includes –

- (a) office towers;
- (b) shophouses and shopping complexes;
- (c) convention and exhibition complexes;
- (d) markets and food centres;
- (e) hotels, boarding houses, guest houses, service apartments, student hostels and workers’ dormitories;
- (f) resort developments;
- (g) factories and warehouses;
- (h) utilities and telecommunication installations,
- (i) business or technology park developments;
- (j) ports of entry for land, air and sea, including immigration checkpoints
- (k) bus terminals, bus interchanges or train stations, including Mass Rapid Transit System (MRT) stations and Light Rail Transit System (LRT) stations;
- (l) fire stations, police stations, civil defence buildings, military camps, prison buildings, hospitals, government offices or embassies;
- (m) places of worship;

- (n) libraries, museums, community clubs or centres, association buildings, sports and recreational complexes, homes for the aged and hospices; and
- (o) primary schools, secondary schools, junior colleges, universities, polytechnics, foreign and specialist schools;

“owner” –

- (a) in relation to any premises comprised in a strata title plan under the Land Titles (Strata) Act (Cap. 158), means —
 - (i) in the case of a lot, the person who is registered as the subsidiary proprietor of the lot under that Act;
 - (ii) in the case of a common property, the management corporation having control of that common property, or the person receiving any rent or charge for the maintenance and management of that common property; and
 - (iii) in the case of a limited common property as defined in section 2(1) of the Building Maintenance and Strata Management Act, the subsidiary management corporation established by the Building Maintenance and Strata Management Act having control of that limited common property, or the person receiving any rent or charge for the maintenance and management of that limited common property;
- (b) in relation to a building in a housing estate of the Housing and Development Board (called a HDB housing estate) or a subdivided building in a housing estate as defined in section 2(1) of the HUDC Housing Estates Act (Cap. 131) (called a HUDC housing estate), means —
 - (i) in the case of a flat, any owner of the flat as defined in section 2(1) of the Housing and Development Act or section 2(1) of the HUDC Housing Estates Act, as the case may be;
 - (ii) in the case of the building’s common property in a HDB housing estate that is controlled, managed and maintained by a Town Council, that Town Council;
 - (iii) in the case of the building’s common property in a HDB housing estate that is not controlled, managed and maintained by a Town Council, the Housing and Development Board; and
 - (iv) in the case of the subdivided building’s common property in a HUDC housing estate, any body corporate constituted under section 3 of the HUDC Housing Estates Act;
- (c) in relation to a subdivided building other than a subdivided building mentioned in paragraph (a) or (b), means —

- (i) in the case of a lot, the person who is registered under the Land Titles Act (Cap. 157) as the proprietor of the fee simple, estate in perpetuity or leasehold estate of that lot; and
 - (ii) in the case of the subdivided building's common property, every person who is registered under the Land Titles Act as the proprietor of the fee simple, estate in perpetuity or leasehold estate of a lot in that building, or the person receiving any rent or charge for the maintenance and management of the common property;
- (d) in relation to any premises which are not subdivided, means any person who is registered under the Land Titles Act as the proprietor of the fee simple, estate in perpetuity or leasehold estate of those premises; and
- (e) in relation to any other premises or building, means the person for the time being receiving the rent of the premises or building, whether on the person's own account or as agent, trustee or receiver, or who would receive such rent if the premises or building were let to a tenant, and includes the person whose name is entered in the Valuation List prepared under section 10 of the Property Tax Act (Cap. 254) as the owner of the premises or building, or a mortgagee in possession;

"premises" has the same meaning as in section 2(1) of the Building Control Act (Cap. 29);

"previous codes" means any previously issued codes of practice or guidelines which specified the space and facilities to be provided by developers or owners of buildings for the purpose of enabling the deployment and operation of installation or plant to provide telecommunication services to the buildings, including –

- (a) the Code of Practice for Info-communication Facilities in Buildings 2013 issued by the Info-communications Development Authority of Singapore ("IDA") on 1 May 2013;
- (b) the Guidelines for Info-communication Facilities in Buildings issued by IDA on 1 May 2013;
- (c) the Code of Practice for Info-communication Facilities in Buildings issued by IDA on 15 September 2008;
- (d) the Guidelines for Info-communications Facilities in Buildings issued by IDA on 15 September 2008 including its addendum dated 6 September 2011;
- (e) the Code of Practice for Info-communication Facilities in Buildings issued by IDA on 15 September 2000 including its addendums dated 15 March 2001 and 15 September 2006;
- (f) the Code of Practice for Telecommunication Facilities in Buildings issued by the Telecommunication Authority of Singapore in March

1997;

- (g) the Revised Guidelines for the Provision of Telecommunication Facilities by Developers issued by Singapore Telecommunications Ltd in 1994; and
- (h) the Guidelines for the Provision of Telecommunication Facilities by Developers issued by the Telecommunication Authority of Singapore in 1988;

“public road” means any road over which the public has a right of way;

“relevant space and facilities” means the space and facilities provided by the developer or owner of a land or building pursuant to this Code or any previous codes;

“RJ45 patch panel” means a panel for mounting RJ45 outlets for patching purposes;

“SC/APC connector” means standard connector/angle polished connector;

“strata landed dwelling-house” means a landed dwelling-house comprised in a development the strata sub-division of which is permitted under a written permission granted by the competent authority under section 14 (4) of the Planning Act (Cap. 232) or authorised by the Minister under section 21 (6) of the Planning Act;

“telecommunication equipment room” means a room within a building or a development that is used to house a licensee’s installation, plant or system;

“telecommunication riser” means a compartment that is used to house and distribute telecommunication cables to the individual storeys of a building;

“temporary occupation permit” has the same meaning as in the Building Control Act (Cap. 29);

“Town Council” means a Town Council established by section 4 of the Town Councils Act (Cap. 329A);

“trunking” means an enclosed space which is used to house and conceal cables and includes spaces provided in a wall and in the skirting of walls and partitions;

“underground pipes” –

- (a) in relation to a landed dwelling-house, means the pipes which extend from the boundary of the house into the house;
- (b) in relation to a development consisting of strata landed dwelling-houses, means the pipes which extend from the boundary of the development to the main distribution frame room or to the retaining wall of the development (as the case may be) and which extend from the main distribution frame room or retaining wall to each strata landed dwelling-house within the development; and

- (c) in relation to a development consisting of a building or buildings other than landed dwelling-houses or strata landed dwelling-houses, means the pipes which extend from the boundary of the development to the main distribution frame room or to the retaining wall of the development (as the case may be) and which extend from the main distribution frame room or retaining wall to the telecommunication equipment room or telecommunication riser within the development; and

“usable floor area” refers to any floor space within a development which is to be served by any telecommunication system (excluding any floor spaces that are served only by public cellular mobile telecommunication systems).

1.3 Purpose of this Code

1.3.1 This Code specifies –

- (a) the space and facilities that the developer or owner of a land or building shall provide at its own cost and expense to enable the deployment and operation of installation, plant or systems to be used for telecommunications;
- (b) the duties that shall be observed by the developer or owner of a land or building in relation to the space and facilities provided within, or on, the land or building pursuant to this Code or previous codes; and
- (c) the duties that shall be observed by a licensee who deploys and operates its installation, plant or systems within the relevant space and facilities.

1.3.2 In this Code, a reference to the owner of a development, land or building shall, where the context admits, include a reference to the owner of any individual premises, lot, unit or flat within the development, land or building.

1.4 Application of this Code

1.4.1 Where a development has been granted provisional or written permission for its construction by the competent authority under the Planning Act (Cap. 232) on or after the Effective Date, the developer or owner of the development shall, unless it obtains a waiver from IMDA in accordance with paragraph 1.5, provide the space and facilities described in chapters 4 to 10, as may be applicable, at its own cost and expense.

1.4.2 Subject to paragraphs 1.4.3 to 1.4.5, chapters 4 to 10 specify the space and facilities to be provided for the following types of development –

- (a) development consisting of 1 or more landed dwelling-houses abutting an existing road (Chapter 4);
- (b) development consisting of 2 or more landed dwelling-houses abutting a new road to be constructed by the developer or owner (Chapter 5);
- (c) development consisting of 2 or more strata landed dwelling-houses (Chapter 6);

- (d) development consisting of 1 or more multi-storey residential buildings (Chapter 7);
- (e) development consisting of 1 or more non-residential buildings of a total usable area of more than 2,000m² (Chapter 8);
- (f) development consisting of 1 or more non-residential buildings of a total usable area of up to and including 2,000m² (Chapter 9); and
- (g) development consisting of 1 or more road or train tunnels (Chapter 10).

For the avoidance of doubt, in relation to a development consisting of townhouses, the space and facilities to be provided are specified in chapters 6 and 7, as may be applicable.

1.4.3 Where a development consists of –

- (a) 1 or more mixed-use buildings; or
- (b) a mix of landed dwelling-houses, strata landed dwelling-houses, multi-storey residential buildings, non-residential buildings, mixed-use buildings or any combination thereof,

the developer or owner shall refer to and provide the relevant space and facilities specified in chapters 4 to 10 corresponding to the use or type of building in the development. For the avoidance of doubt, a set of space and facilities provided for the residential portion of a development shall not be counted towards the requirement for the relevant space and facilities for the non-residential portion or vice-versa. For example, in the case of a development consisting of a multi-storey mixed-use building, the developer or owner shall provide the space and facilities specified in chapter 7 in respect of the residential portion of the building and provide the space and facilities specified in chapter 8 or 9 (as the case may be) in respect of the non-residential portion of the building. In the event of any uncertainty as to the space and facilities to be provided, the developer or owner shall consult IMDA for clarification.

1.4.4 Where a development consists of any buildings (or any parts thereof) used for the provision of vital services such as –

- (a) hospitals;
- (b) ports of entry for land, air and sea, including immigration checkpoints
- (c) police and fire stations;
- (d) utilities plants;
- (e) data centres; and
- (f) key financial centres such as the Stock Exchange,

the developer or owner shall provide, unless exempted by IMDA, an additional set of infrastructure that is required for resiliency and diversity purposes, with respect to the following –

- (i) lead-in pipes;
- (ii) main distribution frame room; and
- (iii) telecommunication risers.

The additional set of infrastructure must be provided at a different location from the first set of infrastructure with the second set of lead-in pipes leading to different roads. The additional set of infrastructure need not be equal to the first set in terms of size, scale or proportions so long as it is reasonable to meet the diversity needs of the vital services in these buildings. In the event of any uncertainty as to whether a building is used for the provision of vital services, the developer or owner shall consult IMDA for clarification.

- 1.4.5 Where the space and facilities to be provided for a particular development are not specified in this Code, the developer or owner shall consult IMDA on the space and facilities to be provided at its own cost and expense for such development and comply with such requirements as may be imposed by IMDA.
- 1.4.6 The developer or owner of a development that has already been issued with a Temporary Occupation Permit at the Effective Date or a development that is issued with a Temporary Occupation Permit on or after the Effective Date, shall comply with chapter 2 of this Code, unless it obtains a waiver from IMDA in accordance with paragraph 1.5.
- 1.4.7 Every developer or owner who is required to provide -
- (a) lead-in pipes, underground pipes or manholes;
 - (b) main distribution frame rooms;
 - (c) telecommunication equipment rooms;
 - (d) mobile deployment spaces;
 - (e) telecommunication risers;
 - (f) coaxial cables with associated splitters and F-type TV outlets; and/or
 - (g) optical fibre cables with associated fibre interface points and fibre termination points,
- pursuant to chapters 4 to 10 of this Code shall comply with the additional specific requirements set out in chapters 11 to 15 of this Code, as the case may be.
- 1.4.8 Every licensee who uses the space and facilities provided by a developer or owner pursuant to this Code or any previous codes shall comply with chapter 16 of this Code.
- 1.4.9 Nothing in this Code shall limit IMDA's power to issue a direction under section 21 of the Telecommunications Act.

- 1.4.10 For the avoidance of doubt, the obligations imposed on a developer or owner in this Code shall be borne solely by the developer or owner. Without limitation, no developer or owner shall be excused from any failure to observe the requirements of this Code on the ground that such failure arises from the acts or omissions of any consultant or contractor whom it engages to design and construct the development or any managing agent whom it engages to manage the development.

1.5 Waiver

- 1.5.1 IMDA may, on receipt of an application in relation to the space and facilities to be provided in accordance with this Code, waive any of the requirements specified in this Code upon and subject to such terms and conditions as it thinks fit.
- 1.5.2 Any such application shall be made in writing to IMDA by or on behalf of the developer or owner of the development to which such application relates and shall –
- (a) state the nature and extent of and reasons for the proposed waiver of such requirements; and
 - (b) be accompanied by such plans and particulars as may be required to support the application.
- 1.5.3 A waiver may be permanent, temporary (either for a fixed period or effective until the occurrence of a specific event) or on a one-time basis.

1.6 Cancellation and transitional provisions

- 1.6.1 The Code of Practice for Info-communications Facilities in Buildings 2013 issued by IDA on 1 May 2013 (hereinafter referred to as “the cancelled Code”) is cancelled.
- 1.6.2 Notwithstanding paragraph 1.6.1, the cancelled Code shall in relation to buildings which are under construction on the Effective Date, continue to apply in relation to the space and facilities to be provided by the developer or owner as if that Code had not been cancelled. For the purposes of this paragraph, a building shall be under construction if either provisional or written permission for its construction had been granted under the Planning Act (Cap. 232) but no certificate of statutory completion had been issued in respect of the building.
- 1.6.3 For the avoidance of doubt, nothing in paragraph 1.6.1 shall exempt any developer or owner from his obligation to provide space and facilities in accordance with the cancelled Code or any other previous code to the extent that the cancelled Code or other previous code applied to it prior to the Effective Date.
- 1.6.4 Nothing in paragraph 1.6.2 shall require any developer or owner to comply with the cancelled Code if it was not already required to do so before the Effective Date.

- 1.6.5 Where there is an agreement subsisting immediately before the Effective Date between the developer or owner and a mobile telecommunication licensee pursuant to which the licensee is paying the developer or owner any fee or charge for the use of any space and facilities in the development for the deployment of its installation, plant or system, the developer or owner may designate such space and facilities as mobile deployment space for the purposes of this Code and may continue to collect the fee or charge payable in accordance with the agreement, provided that:
- (a) the space and facilities satisfy the requirements applicable to mobile deployment space as specified in this Code (including but not limited to requirements pertaining to size and location); and
 - (b) the developer or owner complies with all other provisions of this Code in relation to mobile deployment space.

1.7 Guidelines

- 1.7.1 The guidelines titled “Guidelines for Info-communication Facilities in Buildings” shall be read in conjunction with this Code. Developers and owners should refer to the guidelines for the technical specifications of the space and facilities to be provided under this Code and the recommended practices in relation to the construction thereof.

CHAPTER 2 PROVISION OF MOBILE DEPLOYMENT SPACE AND OBLIGATIONS OF DEVELOPER OR OWNER IN RELATION TO THE PROVISION, MAINTENANCE AND GRANT OF USE OF, AND ACCESS TO, SPACE AND FACILITIES

2.1 Application of this chapter

2.1.1 This chapter applies to –

- (a) a development that has already been issued the Temporary Occupation Permit by the relevant authority at the Effective Date (“Completed Development”); and
- (b) a development that is issued the Temporary Occupation Permit by the relevant authority on or after the Effective Date,

and specifies –

- (i) in relation to both a Completed Development and a development that is issued the Temporary Occupation Permit on or after the Effective Date, the developer’s or owner’s obligation to –
 - (A) provide mobile deployment space;
 - (B) provide, maintain and grant licensee’s the use of, and access to, the relevant space and facilities provided within the development; and
 - (C) seal underground pipes entering into enclosed rooms within the development; and
- (ii) in relation to a development that is issued the Temporary Occupation Permit on or after the Effective Date, the developer’s or owner’s obligation to provide additional 2-way air-blown fibre microducts upon subdivision of units within the development insofar as the developer or owner is required comply with chapters 8 and 9 of this Code.

2.1.2 IMDA reserves the right to require any developer or owner of a Completed Development or a development that is issued the Temporary Occupation Permit on or after the Effective Date to provide additional space and facilities to meet the demand for telecommunication services where necessary.

2.2 Obligation to provide mobile deployment space in Completed Developments and developments that are issued the Temporary Occupation Permit on or after the Effective Date

2.2.1 The developer or owner of a Completed Development or a development that is issued the Temporary Occupation Permit on or after the Effective Date shall provide mobile deployment space in accordance with all the requirements specified in this paragraph 2.2 at its own cost and expense, unless otherwise stated.

2.2.2 As a general principle, the mobile deployment space provided by a developer or owner of a development shall be prioritised to serve the mobile coverage needs of the development. Nevertheless, to enable mobile telecommunication licensees to optimise the use of mobile deployment space to provide mobile coverage to multiple

buildings using the same set of installation, plant and systems, mobile telecommunication licensees may, in addition to serving the relevant development, use the mobile deployment space to provide mobile coverage to any land or building located outside of the development. For the avoidance of doubt, no developer or owner shall refuse to provide mobile deployment space on the ground that it will be used by a mobile telecommunication licensee to provide mobile coverage to any external properties in addition to the relevant development.

- 2.2.3 If the development consists of 1 or more multi-storey residential buildings, with 80 or more residential units, the developer or owner shall, where required and notified by any mobile telecommunication licensee, provide within a reasonable time, mobile deployment space in accordance with the dimensions specified in Table 2.2.3 based on the total number of residential units in the development. If the development consists of more than 1500 residential units, the developer or owner shall consult IMDA on the mobile deployment space to be provided and comply with such requirements as may be imposed by IMDA.

Table 2.2.3 Mobile deployment space to be provided in a development consisting of 1 or more multi-storey residential buildings

Total number of residential units in the development	Mobile deployment space (m ²)	Minimum height of mobile deployment space (m)
80 to 200	24	3
201 to 600	36	
601 to 1500	54	
> 1500	To consult IMDA	

- 2.2.4 If the development consists of 1 or more non-residential buildings (all of which are not tunnels) with a total mobile coverage area of more than 2,000m², the developer or owner shall, where required and notified by any mobile telecommunication licensee, provide within a reasonable time, mobile deployment space in accordance with the dimensions as specified in Table 2.2.4 based on the mobile coverage area in the development. If the development consists of a total mobile coverage area of more than 200,000m², the developer or owner shall consult IMDA on the mobile deployment space to be provided and comply with such requirements as may be imposed by IMDA.

Table 2.2.4 Mobile deployment space to be provided in a development consisting of 1 or more non-residential buildings

Total mobile coverage area ('000 m ²)	Mobile deployment space (m ²)	Minimum height of mobile deployment space (m)
> 2 to ≤ 6	24	3
> 6 to ≤ 20	36	
> 20 to ≤ 100	54	
> 100 to ≤ 200	72	
> 200	To consult IMDA	

- 2.2.5 The amount of mobile deployment space provided by a developer or owner shall be computed based on the footprint (i.e. floor space) occupied by the installation, plant or systems (e.g. antennas, base stations, remote radio units, combiners and power

- distribution boxes) deployed by a mobile telecommunication licensee at the mobile deployment space.
- 2.2.6 For the avoidance of doubt, the space occupied by facilities required to be installed to serve the installation, plant and systems deployed by a mobile telecommunication licensee at the mobile deployment space (e.g. cable distribution systems and power distribution systems) shall not be counted towards the computation of the mobile deployment space.
- 2.2.7 Where a mobile telecommunication licensee requires any additional space, the mobile telecommunication licensee shall consult with and obtain the approval of the developer or owner for the provision of such additional space, on such prices, terms and conditions as may be agreed between the parties.
- 2.2.8 The developer or owner shall, where required and notified by any mobile telecommunication licensee, within a reasonable time, grant the mobile telecommunication licensee access to all common areas within the development which may reasonably serve as mobile deployment space (including but not limited to building rooftops) to enable the mobile telecommunication licensee to carry out feasibility studies and site surveys to identify suitable mobile deployment spaces.
- 2.2.9 The location of the mobile deployment space to be provided under paragraphs 2.2.3 and 2.2.4 shall be determined by the mobile telecommunication licensee in consultation with the developer or owner, subject to the following –
- (a) where feasible, the mobile deployment space shall be located on the rooftops of buildings to optimise the coverage of the installation, plant or systems to be deployed by the mobile telecommunication licensee;
 - (b) there should be sufficient space around the mobile deployment space to reasonably enable the mobile telecommunication licensee to carry out any requisite works in relation to the installation, plant or systems to be deployed in the mobile deployment space;
 - (c) the mobile telecommunication licensee shall, where practicable, take suitable measures to address any reasonable concerns that the developer or owner may have in relation to the aesthetics of the mobile deployment space;
 - (d) the mobile deployment space may be split into one (1) or more locations within the development so as to facilitate the provision of public cellular mobile telecommunication services to the whole development, provided that the total amount of mobile deployment space at all locations combined shall not exceed the maximum amounts specified in paragraphs 2.2.3 and 2.2.4;
 - (e) the mobile deployment space shall be located at unused spaces within the development;
 - (f) the mobile deployment space shall not be located in the main distribution frame room or the telecommunication equipment room, unless there is sufficient space available after having fulfilled the space requirements of the main distribution frame room or telecommunication equipment room and there is a clear demarcation of the space designated as mobile deployment space; and
 - (g) the mobile deployment space shall not be located in any area that –

- (i) is susceptible to the risk of flooding;
- (ii) is directly subject to the discharge of water, steam, fumes, gases or dust;
- (iii) is within or near a bin centre; and
- (iv) is not able to withstand a loading of 1.5kN/m² or more; and
- (v) will subject the installation, plant or systems deployed therein to vibration of more than 0.05 G, where G is the acceleration due to gravity (G=9.81 m/s²).

2.2.10 Where a developer or owner objects to the location of any mobile deployment space selected by the mobile telecommunication licensee, both parties shall co-operate in good faith to resolve the matter in a timely manner, having regard to parameters stated in paragraph 2.2.9. In the event that parties are unable to reach agreement, they may refer the matter to IMDA for a decision which shall be binding on the parties.

2.2.11 Where –

- (a) the developer or owner is responsible for complying with any statutory or regulatory requirements or obtaining any requisite approvals for its provision of the mobile deployment space, the developer or owner shall do so in a timely manner; and
- (b) the mobile telecommunication licensee is responsible for complying with any statutory or regulatory requirements or obtaining any requisite approvals for its use of the mobile deployment space, the developer or owner shall render all necessary assistance as the mobile telecommunication licensee may reasonably require in a timely manner to enable the mobile telecommunication licensee to do so (e.g. providing the developer's or owner's endorsement, where required, on applications submitted by the mobile telecommunication licensee to relevant authorities in connection with the mobile deployment space), save that the mobile telecommunication licensee shall bear the cost and expense for carrying out any actions within its responsibility.

2.2.12 Where the mobile telecommunication licensee requires lighting and ventilation to be provided at a mobile deployment space to enable the mobile telecommunication licensee to deploy and operate its installation, plant or system at that location, the developer or owner shall render all necessary access and assistance in a timely manner to facilitate the provision of such lighting and ventilation, save that the mobile telecommunication licensee shall bear the cost and expense for the provision of the necessary lighting and ventilation.

2.2.13 Where the mobile telecommunication licensee requires –

- (a) facilities (e.g. cable distribution system and power distribution system) to be installed to serve its installation, plant or system at the mobile deployment space; or
- (b) works to be carried out in connection with the installation of such facilities and use of the mobile deployment space (e.g. drilling and coring works, and the opening and reinstatement of false ceilings and access panels),

the developer or owner shall provide all necessary access and assistance in a timely

manner to facilitate such installation or works by the mobile telecommunication licensee, save that the mobile telecommunication licensee shall bear the cost and expense for the installation of the necessary facilities and the carrying out of the necessary works.

- 2.2.14 Without prejudice to paragraph 2.2.13, the developer or owner shall ensure that the electrical consumer switch room has sufficient power capacity (up to 32A, 3 phase 50Hz power supply per mobile telecommunication licensee) to supply electricity for the operation of the installation, plant or system deployed by the mobile telecommunication licensee at the mobile deployment space.
- 2.2.15 Where the developer or owner reasonably desires to use the mobile deployment space for other purposes such that it is necessary for the mobile telecommunication licensee to relocate its installation, plant or system deployed at the mobile deployment space to another location within the development, the developer or owner shall –
- (a) ensure that the alternative location within the development is reasonably fit for the purposes of serving as a mobile deployment space; and
 - (b) bear all costs and expenses reasonably incurred by the mobile telecommunication licensee in connection with the relocation of its installation, plant or system,

save that where the developer or owner requires the mobile telecommunication licensee to remove its installation, plant or system due to the need to demolish the building, the mobile telecommunication licensee shall bear its own costs and expenses for such removal.

2.3 Obligation to provide, maintain and grant the use of, and access to, relevant space and facilities in Completed Developments and developments that are issued the Temporary Occupation Permit on or after the Effective Date

- 2.3.1 The developer or owner of a Completed Development or a development that is issued the Temporary Occupation Permit on or after the Effective Date shall comply with all the requirements specified in paragraphs 2.3 to 2.7 at its own cost and expense, unless otherwise stated.
- 2.3.2 The developer or owner shall provide, maintain and grant licensees the use of, and access to, the space and facilities required to be provided under this Code or any previous codes, including but not limited to the following –
- (a) main distribution frame rooms;
 - (b) telecommunication equipment rooms and coaxial distribution rooms;
 - (c) telecommunication risers;
 - (d) lead-in pipes, underground pipes and manholes (including manhole covers);
 - (e) cable distribution systems;
 - (f) 2-way air-blown fibre microducts (for non-residential developments only); and
 - (g) mobile deployment space.

- 2.3.3 The developer or owner shall not, in relation to a licensee's use of, and access to, the relevant space and facilities, impose –
- (a) any costs, expenses, charges or rent (including but not limited to administrative charges and security escort charges) on the licensee; or
 - (b) any additional requirements that may have the effect of requiring the licensee to incur any additional costs or expenses (including but not limited to requiring the licensee to take up any insurance policy or additional insurance coverage).
- 2.3.4 The developer or owner may require a licensee to place a deposit in connection with any significant works (e.g. deployment of installation, plant or systems, and other major installation works) to be carried out by the licensee in relation to its use of, and access to, the relevant space and facilities provided that such deposit meets the following requirements –
- (a) the deposit must be refundable (subject to any deductions based on reasonable criteria that are made known to the licensee in advance);
 - (b) the deposit must be refunded to the licensee promptly after completion of the works; and
 - (c) the deposit must be of a reasonable amount, taking into consideration the scope of the works.
- For the purposes of this paragraph, a licensee's conduct of site surveys and associated preparatory work, general inspections and maintenance, minor upgrades and repairs to its installation, plant or system, and other minor works relating to the installation of facilities, shall not be regarded as significant works.
- 2.3.5 The developer or owner is not required to bear the utility charges for the operation of any installation, plant or system deployed by any licensee in the relevant space and facilities.
- 2.3.6 Where the developer or owner requires a licensee to bear the utility charges for the operation of any installation, plant or system deployed by the licensee in the relevant space and facilities, the developer or owner shall serve a notice to this effect on the licensee. The licensee shall bear the utility charges on a prospective basis commencing no earlier than a period of one (1) month from the date of service of such notice.
- 2.3.7 Where the notice specified in paragraph 2.3.6 is served on the licensee, the developer or owner and the licensee shall reach an agreement on the basis upon which to compute the utility charges to be borne by the licensee. Where the developer or owner and the licensee are unable to agree on such basis, the utility charges to be borne by the licensee shall be based on the estimated power consumption of the licensee's installation, plant or system.
- 2.3.8 Notwithstanding paragraph 2.3.7, where it is physically feasible, the licensee may at its own cost, install the necessary electrical installations (including cables, a separate utility meter and any other accessory) to enable the utility charges to be computed on an "as incurred" basis and paid directly to the utilities provider.

- 2.3.9 For the avoidance of doubt, the developer or owner shall not require the licensee to bear any utility charges incurred prior to the commencement date referred to in paragraph 2.3.6.

2.4 Space and facilities for the exclusive use of licensees

- 2.4.1 All relevant space and facilities shall be reserved for the exclusive use of licensees.
- 2.4.2 Without prejudice to the generality of paragraph 2.4.1, the developer or owner shall not use the relevant space and facilities for any purpose. Without limitation, the developer or owner shall not –
- (a) install main distribution frames, local distribution cables or any other equipment in the main distribution frame room, telecommunication equipment room, coaxial distribution room or mobile deployment space of the development for its own use, whether for telecommunication purposes or otherwise;
 - (b) install cables in the lead-in pipes, underground pipes, manholes, cable distribution system or telecommunication risers of the development for its own use, whether for telecommunication purposes or otherwise; or
 - (c) use the relevant space and facilities for the accommodation of any persons or the storage of any items whatsoever.

2.5 Other obligations in relation to relevant space and facilities

- 2.5.1 Where the developer or owner requires an agreement to be put in place in connection with a licensee's use of, and access to, the relevant space and facilities in the development, the developer or owner shall ensure that the terms and conditions of such agreement do not derogate from, and are not inconsistent with, the obligations imposed on the developer or owner under this Code.
- 2.5.2 Subject to paragraph 2.5.4, the developer or owner shall, upon notice being given by a licensee, within a reasonable time, grant the licensee access to the development for the licensee to carry out any works in relation to its use of, and access to, the relevant space and facilities (which may include conducting site surveys and associated preparatory work, installing, inspecting, maintaining, repairing or upgrading the licensee's installation, plant or system). The developer or owner shall ensure that its own internal processes do not cause any undue delay to the grant of access to the licensee.
- 2.5.3 Where the developer or owner objects to the licensee's intended use of, and access to, the relevant space and facilities as notified by the licensee under paragraph 2.5.2, the developer or owner shall raise its objection to the licensee within the timeframe stipulated in the licensee's notification and state the reasons for its objection. Both parties shall co-operate in good faith to resolve the matter in a timely manner. In the event that parties are unable to reach agreement, they may refer the matter to IMDA for a decision which shall be binding on the parties.
- 2.5.4 Where a licensee requires Emergency Access (as defined below) to the relevant space and facilities, the developer or owner shall, upon receipt of such notice by the licensee, grant the licensee access in accordance with the timeframes specified in

Table 2.5.4 below. “Emergency Access” refers to the access required by a licensee for any of the following purposes –

- (a) to carry out urgent works to restore its services due to unforeseen and unscheduled outages, disruptions or downtime, which cannot be resolved by the licensee remotely; or
- (b) to take any action in relation to its installation, plant or systems deployed within the relevant space and facilities in order to comply with any applicable laws, regulatory requirements or lawful orders issued by any competent authority to the licensee.

For the avoidance of doubt, the foregoing shall not in any way limit or affect the developer’s or owner’s obligation to comply with any applicable laws, regulatory requirements or lawful orders issued by any competent authority to the developer or owner in connection with the relevant space and facilities, and access thereto.

Table 2.5.4 Timeframe for Emergency Access to be provided by developer or owner

Building type	Timeframe for Emergency Access to be provided
Manned	Within 2 hours from the receipt of licensee’s notice
Unmanned	As soon as possible and in any case not more than 8 hours from the receipt of licensee’s notice

- 2.5.5 Notwithstanding paragraph 2.3.3, where the developer or owner incurs any reasonable cost and expense in providing Emergency Access to the licensee (e.g. engagement of security escort for unmanned buildings), the licensee shall bear such cost and expense.
- 2.5.6 The developer or owner shall provide all licensees who have deployed installation, plant or systems within the development the contact details of a duly authorised person(s) who must be contactable at all times for the grant of Emergency Access and who is authorised to co-ordinate the grant of Emergency Access to licensees. Where there is any change in the duly authorised person(s), the developer or owner shall update licensees of the same in a timely manner.
- 2.5.7 Where the developer or owner requires the licensee to submit any proposal for cabling works based on the relevant building plans, floor plans or blueprints, the developer or owner shall provide the licensee with at least one (1) set of the relevant building plans, floor plans or blueprints.
- 2.5.8 Where the relevant space and facilities are located at a height of more than 4m above floor level, the developer or owner shall provide the licensee with all necessary assistance in a timely manner to facilitate the licensee’s use of, and access to, such space and facilities, save that the licensee shall be responsible for procuring and implementing the appropriate means of access (e.g. boom lifts, scaffolding, etc) at its own cost and expense. For the avoidance of doubt, this paragraph does not exempt the developer or owner from complying with any applicable obligations under the prevailing statutory or regulatory requirements pertaining to workplace safety and health.

- 2.5.9 The obligation of the developer or owner to grant licensees the use of, and access to, the relevant space and facilities shall, without limitation, include the following –
- (a) where the licensee's access to and use of the relevant space and facilities (e.g. access to vertical pipes, cable trays or metal trunking) is obstructed by any temporary or permanent structure (e.g. false ceiling, panelling or any other form of covering), the developer or owner shall remove such temporary or permanent structures or provide appropriate openings in such structures (e.g. construction of access panels) to grant the necessary access to the licensee;
 - (b) where there are any blockages or obstructions in the relevant space or facilities (e.g. where lead-in or underground pipes are choked with foreign particles, collapsed or damaged) which impede or prevent the licensee from deploying its installation, plant or system within the relevant space and facilities, the developer or owner shall remove or remediate such blockages and obstructions to facilitate deployment by the licensee; and
 - (c) where the licensee encounters difficulty in ascertaining the location of any relevant space and facilities, the developer or owner shall provide the licensee with all necessary assistance (including providing the licensee with the relevant building plans, floor plans or blueprints if required) in a timely manner to enable the licensee to locate the space and facilities.

2.6 Continuing obligation of developers or owners of Completed Developments and developments that are issued the Temporary Occupation Permit on or after the Effective Date to maintain relevant space and facilities

- 2.6.1 The developer or owner of a Completed Development and a development that is issued the Temporary Occupation Permit on or after the Effective Date shall at all times –
- (a) maintain the relevant space and facilities in a condition that is fit for the purpose of its use by licensees;
 - (b) repair any part of the relevant space and facilities that falls into disrepair or is damaged unless such damage is caused by a licensee in which case the developer or owner may require the licensee to carry out the necessary repairs at the licensee's cost and expense; and
 - (c) implement reasonable measures to safeguard the security of the relevant space and facilities.

2.7 Obligation to seal underground pipes entering into enclosed rooms within Completed Developments and developments that are issued the Temporary Occupation Permit on or after the Effective Date

- 2.7.1 Every developer or owner of a development that has –
- (a) any main distribution frame room or telecommunication equipment room which is air-conditioned; or

- (b) any main distribution frame room or telecommunication equipment room that is not air-conditioned and which has no free-flowing ventilation (such as a room with no louvres, exhaust fans or equivalent means of ventilation),

(collectively referred to as an “Enclosed Room”)

shall ensure that it seals all unused underground pipes at its point of entry into such Enclosed Rooms with the Appropriate Sealing Material (as defined in paragraph 2.7.2).

- 2.7.2 “Appropriate Sealing Material” means a material that is able to prevent foreign gaseous matter (which may be toxic or flammable) from passing through the underground pipes into the Enclosed Room and which shall be durable, easily removable to facilitate installation of cables, and not cause damage to the underground pipes or any telecommunication cables that may be installed therein.

2.8 Obligation to provide additional 2-way air-blown fibre microducts and accompanying accessories upon subdivision of units within non-residential developments that are issued the Temporary Occupation Permit on or after the Effective Date

2.8.1 Where –

- (a) a 2-way air-blown fibre microduct and its accompanying accessories has been installed from the telecommunication riser of a building to any individual unit within that building pursuant to chapters 8 or 9 of this Code; and
- (b) such unit is subdivided into two (2) or more units,

the developer or owner of the subdivided unit(s) shall ensure that a 2-way air-blown fibre microduct and its accompanying accessories are installed from the telecommunication riser of the building to the subdivided unit(s) in accordance with the requirements specified in chapters 8 and 9 of this Code, at its own cost and expense.

- 2.8.2 Where it is necessary for the 2-way air-blown fibre microduct and its accompanying accessories to be installed in any common property within a building (e.g. telecom riser and common corridor) to comply with the requirement above, the developer or owner having control or management of the common property shall render such assistance as may be required to facilitate such installation in a timely manner.

CHAPTER 3 SUBMISSION OF INFORMATION BY THE DEVELOPER OR OWNER

3.1 Application of this chapter

- 3.1.1 This chapter specifies the information submission requirements to be observed by the developer or owner of a development who is required to provide space and facilities under this Code.

3.2 Building plans to incorporate requirements of Code

- 3.2.1 Where a development has been granted provisional or written permission for its construction by the competent authority under the Planning Act (Cap. 232) on or after the Effective Date, the developer or owner shall ensure that the building plans for the development fully and accurately incorporate the requirements of this Code, as may be applicable, before construction of the development commences.

3.3 Submission of building plans to the Telecommunication Facility Co-ordination Committee (TFCC)

- 3.3.1 The developer or owner shall submit the building plans to the Telecommunication Facility Co-ordination Committee ("TFCC") during the planning stage of the development together with the following information –

- (a) the name and contact details (including contact number and address) of the developer or owner;
- (b) the names and contact details (including contact numbers and addresses) of the consultants and contractors engaged for the building works, including the architect, the M&E consultant and building contractors;
- (c) the location of the development;
- (d) the proposed number of units and the usable floor area;
- (e) the intended use of the development;
- (f) the estimated dates of commencement and completion of the building works;
- (g) the estimated date of issuance of the Temporary Occupation Permit by the relevant authority ("TOP Date"); and
- (h) the house or unit numbering plan.

- 3.3.2 In addition to the information required in paragraph 3.3.1, the developer or owner shall submit –

- (a) the site plan indicating the location of the proposed development; and
- (b) building plans indicating the space and facilities (excluding mobile deployment space) provided for the development as specified in chapters 4 to 10 (as the case may be).

- 3.3.3 The building plans, including the softcopy of drawings and cover letter detailing the information required under paragraphs 3.3.1 and 3.3.2, shall be submitted electronically to the TFCC via the Building and Construction Authority's CORENET e-Submission system.

3.4 Submission of building plans for provision of mobile coverage

- 3.4.1 Where the developer or owner wishes to arrange for the mobile telecommunication licensees to deploy their installation, plant or systems in the development prior to the TOP Date so as to enable the provision of mobile coverage to the development from the TOP Date, the developer or owner shall provide the following information to the mobile telecommunication licensees –

- (a) the name and contact details (including contact number and address) of the developer or owner;
- (b) the names and contact details (including contact numbers and addresses) of the consultants and contractors engaged for the building works, including the architect, the M&E consultant and building contractors;
- (c) the location of the development;
- (d) the proposed number of units and the usable floor area;
- (e) the intended use of the development;
- (f) the estimated dates of commencement and completion of the building works;
- (g) the estimated TOP Date; and
- (h) the mobile coverage area.

- 3.4.2 The information specified in paragraph 3.4.1 shall be submitted to the mobile telecommunication licensees at their respective email addresses below –

SingTel Mobile Singapore Pte Ltd	g-stmscp13@singtel.com
M1 Limited	m1mfcc@m1.com.sg
StarHub Mobile Pte Ltd	mobilesetup@starhub.com
TPG Telecom	TPGsetup@tpgtelecom.com.sg

CHAPTER 4 DEVELOPMENT CONSISTING OF 1 OR MORE LANDED DWELLING-HOUSES ABUTTING AN EXISTING ROAD

4.1 Application of this chapter

4.1.1 This chapter specifies the space and facilities to be provided for a development consisting of 1 or more landed dwelling-houses abutting an existing road. IMDA reserves the right to require any developer or owner to provide additional space and facilities, to meet the demand for telecommunication services where necessary.

4.2 Provision of lead-in pipes and underground pipes

4.2.1 Subject to paragraph 4.2.2, every landed dwelling-house shall be provided, at the minimum, with –

- (a) 2 lead-in pipes which shall extend from the gate pillar of the house to the abutting road, to a point 1m beyond the roadside drain located immediately outside the house (referred to as the “First Lead-In Pipe” and “Second Lead-In Pipe” respectively); and
- (b) 2 underground pipes which shall run from the gate pillar of the house into the house, terminating at the utility room or closet (referred to as the “First Underground Pipe” and “Second Underground Pipe” respectively).

4.2.2 Where there are 1 or more existing lead-in pipes running from outside the development into the development, and the developer or owner intends to redevelop the development, the developer or owner shall provide and connect the new underground pipes required in paragraph 4.2.1 to the existing lead-in pipes as specified in Table 4.2.2, and reduce the number of new lead-in pipes to be provided as specified in Table 4.2.2.

Table 4.2.2 Manner in which new underground pipes are to be connected and number of new lead-in pipes to be provided

Number of existing lead-in pipes	Manner in which new underground pipes are to be connected	Number of new lead-in pipes to be provided
1	The First Underground Pipe shall be connected to the existing lead-in pipe, and Second Underground Pipe shall be unconnected	1
2	Both the First Underground Pipe and the Second Underground Pipe shall be connected to the 2 existing lead-in pipes	0

4.2.3 For the purposes of paragraph 4.2.1 and 4.2.2, all lead-in pipes and underground pipes shall be made of unplasticised polyvinyl chloride (uPVC) material with a nominal diameter of 50mm and be compliant with the Singapore Standard SS:141 Class C.

- 4.2.4 In addition to the requirements set out in paragraphs 4.2.1 to 4.2.3, all lead-in pipes and underground pipes shall be provided in accordance with the requirements set out in chapter 11.

4.3 Provision of cables in underground pipes

- 4.3.1 With regard to the underground pipes referred to in paragraph 4.2.1 –
- (a) a minimum of 1 4-core optical fibre cable complying with ITU-T G.652.D specifications shall be provided in the First Underground Pipe, which shall terminate into a fibre termination point with 4 sets of SC/APC connectors at one end (which may be located in the utility room or closet) and into a fibre termination point with 4 sets of SC/APC connectors located in the gate pillar at the other end. The 4-core optical fibre cable, SC/APC connectors and fibre termination points shall be provided in accordance with the requirements set out in chapter 15; and
 - (b) 1 draw rope shall be provided in the Second Underground Pipe.

4.4 Provision of internal telecommunication wiring

- 4.4.1 Every landed dwelling-house shall be provided, at the minimum, with –
- (a) RG6 coaxial cable(s) of a number equal to the total number of living room(s) and bedroom(s), which shall terminate into the output of a multi-way splitter (which may be located in the utility room or closet) at one end, and into an F-type TV outlet in each of the living room(s) and bedroom(s) at the other end. The RG6 coaxial cable(s) shall be provided in accordance with the requirements set out in chapter 14;
 - (b) 1 RG6 coaxial cable, which shall terminate into the input of the splitter (which may be located in the utility room or closet) at one end, and into an IEC 61169-2 coaxial connector in the living room. This RG6 coaxial cable and IEC 61169-2 coaxial connector shall be located at the opposite wall of the TV outlet described in paragraph 4.4.1 (a), and shall be near a window, to enable the installation of an indoor antenna. The RG6 coaxial cable shall be provided in accordance with the requirements set out in chapter 14; and
 - (c) unshielded twisted pair cable(s) (Category 6 or better) complying with TIA 568-C specifications of a number equal to the total number of specified location(s) within the landed dwelling-house, as set out in Table 4.4.1 below, which shall terminate into an RJ45 patch panel (which may be located in the utility room or closet) at one end, and into an RJ45 outlet in each of the specified location(s) at the other end within the landed dwelling-house. The length of each unshielded twisted pair cable shall not exceed 90m.

Table 4.4.1 Number of unshielded twisted pair cable(s) to be provided

Location within landed dwelling-house	Number of unshielded twisted pair cable(s) (Category 6 or better) per location
Living room	2
Master bedroom	2
Kitchen	1
Bedroom(s)	1
Above the main entrance	1
Ceiling or high along the wall of the living room	1

4.4.2 The developer or owner shall ensure that the installation of all cables required to be provided under this Code is only performed by licensed telecommunication internal wiring contractors.

4.5 Provision of electrical switch socket outlet

4.5.1 Every landed dwelling-house shall be provided with a minimum of two (2) 13A electrical switch socket outlets, which shall be placed adjacent to the fibre termination point (which may be located in the utility room or closet) referred to in paragraph 4.3.1(a).

4.5.2 Every outlet referred to in paragraph 4.4.1 shall be placed adjacent to a 13A electrical switch socket outlet.

4.6 Relevant space and facilities to be ready 3 months prior to the date of issuance of Temporary Occupation Permit

4.6.1 Where the developer or owner wishes to have telecommunications services provided to the development commencing from the date of issuance of the Temporary Occupation Permit by the relevant authority ("TOP Date"), the developer or owner shall ensure that the relevant space and facilities (e.g. underground and lead-in pipes) are ready for use by the licensees at least 3 months before the TOP Date.

4.7 Obligation to provide, maintain and grant the use of, and access to, space and facilities

4.7.1 The developer or owner shall comply with the requirements specified in paragraphs 2.3 to 2.6 of chapter 2, which shall apply mutatis mutandis to the space and facilities required to be provided under this chapter.

CHAPTER 5 DEVELOPMENT CONSISTING OF 2 OR MORE LANDED DWELLING-HOUSES ABUTTING A NEW ROAD TO BE CONSTRUCTED BY THE DEVELOPER OR OWNER

5.1 Application of this chapter

- 5.1.1 This chapter specifies the space and facilities to be provided for a development consisting of 2 or more landed dwelling-houses abutting a new road to be constructed by the developer or owner. All references to landed dwelling-houses in this chapter shall refer only to such type of houses. IMDA reserves the right to require any developer or owner to provide additional space and facilities, to meet the demand for telecommunication services where necessary.
- 5.1.2 If the relevant development consists of more than 1500 landed dwelling-houses, the developer or owner shall consult IMDA on the space and facilities to be provided and comply with such requirements as may be imposed by IMDA.

5.2 Provision of main distribution frame room

- 5.2.1 A minimum of 1 main distribution frame room shall be provided in every relevant development, which shall be constructed at such location within the relevant development as the developer or owner considers appropriate.
- 5.2.2 The size of the main distribution frame room to be provided under paragraph 5.2.1 shall be based on the total number of landed dwelling-houses in the relevant development as specified in Table 5.2.2.

Table 5.2.2 Size of main distribution frame room to be provided in each relevant development

Total number of landed dwelling-houses in the development	Minimum floor area of main distribution frame room (m ²)	Minimum height of main distribution frame room (m)
2 – 10	4	3.5
11 – 20	5	
21 – 30	6	
31 – 60	8	
61 – 120	12	
121 – 200	16	
201 – 400	20	
401 – 600	30	
601 – 800	42	
801 – 1000	49	
1001 – 1500	56	

- 5.2.3 Where the floor area to be provided for the main distribution frame room is 6m² and below, the minimum width of the room shall be 2m. The ratio of the length and width to be provided for a main distribution frame room with a floor area of more than 6m² shall be between 1:1 and 2:1.

- 5.2.4 The developer or owner shall provide for ventilation of the main distribution frame room by way of louvres and, where necessary, exhaust fans in accordance with the requirements set out in chapter 12.
- 5.2.5 Where a relevant development consists of a total of up to 30 landed dwelling-houses –
- (a) 3 sets of electrical distribution panels operating on 230V, single phase, 50Hz power supply connecting to the switch socket outlets; and
 - (b) 20A isolators,
- shall be provided in every main distribution frame room in accordance with paragraphs 5.2.7 and 5.2.8.
- 5.2.6 Where a relevant development consists of a total of more than 30 but up to 1500 landed dwelling-houses –
- (a) 3 sets of electrical distribution panels operating on 230V, single phase, 50Hz power supply connecting to the switch socket outlets; and
 - (b) 30A isolators,
- shall be provided in every main distribution frame room in accordance with paragraphs 5.2.7 and 5.2.8.
- 5.2.7 Every electrical distribution panel shall contain –
- (a) a 30mA residual current circuit breaker of appropriate electrical current rating and miniature circuit breakers for final circuit connections, to facilitate the installation of electrical meters;
 - (b) 2 spare 20A miniature circuit breakers; and
 - (c) a single-line diagram in each panel.
- 5.2.8 Switch socket outlets and isolators shall be provided in the main distribution frame room in accordance with the quantities specified in Table 5.2.8 which are to be distributed evenly among the 3 sets of electrical distribution panels.

Table 5.2.8 Number of switch socket outlets and isolators to be provided in the main distribution frame room of each relevant development

Total number of landed dwelling-houses in the development	Minimum number of switch socket outlets to be provided in main distribution frame room	Minimum number of isolators to be provided in main distribution frame room
30 or below	3 x 2-gang 13A	3 x 20A
31 – 200	3 x 2-gang 13A	3 x 30A
201 – 1500	3 x 2-gang 13A	6 x 30A

- 5.2.9 Natural or electrical lighting (or both) shall be provided in the main distribution frame room.

- 5.2.10 A clean earth of 1Ω or less (without the use of salt) shall be provided for the exclusive use of licensee's installation or plant in the main distribution frame room. The clean earth shall be connected directly to –
- (i) an independent earth electrode system; and
 - (ii) the development's electrical safety earth system.
- 5.2.11 Where a relevant development consists of a total of up to 120 landed dwelling-houses, the clean earth that is provided pursuant to paragraph 5.2.10 shall be in the form of a copper earth bar of at least 300mm in length, 8mm in width and 5mm in thickness, with screw holes that are 6mm in diameter.
- 5.2.12 Where a relevant development consists of a total of more than 120 but up to 1500 landed dwelling-houses, the clean earth that is provided pursuant to paragraph 5.2.10 shall be in the form of a copper earth bar of at least 600mm in length, 8mm in width and 5mm in thickness, with screw holes that are 6mm in diameter.
- 5.2.13 In addition to the requirements set out in paragraphs 5.2.1 to 5.2.12, the main distribution frame room shall be provided in accordance with the requirements set out in chapter 12.

5.3 Provision of underground pipes and manholes to serve the development

- 5.3.1 The developer or owner shall provide underground pipes within the development to –
- (a) enable licensees to link their cables from outside the development to the main distribution frame room; and
 - (b) enable the landed dwelling-houses within the development to be served by the main distribution frame room.
- 5.3.2 The underground pipes shall extend from the main distribution frame room to the nearest new road to be constructed by the developer or owner and shall run along the new road(s) to the boundary of the development and to all houses that are to be served by the main distribution frame room.
- 5.3.3 The number of underground pipes to be provided shall be in accordance with the quantities specified in Table 5.3.3. With the exception of the underground pipes terminating at the boundary of the development, the number of underground pipes provided to other areas within the development may be gradually reduced based on the houses served subject to consultation with IMDA.

Table 5.3.3 Number of underground pipes to be provided from the main distribution frame room to serve the development

Total number of landed dwelling-houses in the development	Total number of underground pipes to be provided
< 200	8
201 – 400	10
401 – 600	12
601 – 800	14
801 – 1000	16
1001 – 1500	18

5.3.4 When entering the main distribution frame room, the underground pipes shall be configured in accordance with the formation specified in Table 5.3.4.

Table 5.3.4 Underground pipe formation in main distribution frame room

Total number of landed dwelling-houses in the development	Pipe formation in the main distribution frame room
< 200	2 x 4
201 – 400	2 x 5
401 – 600	2 x 6
601 – 800	2 x 7
801 – 1000	2 x 8
1001 – 1500	2 x 9

5.3.5 All underground pipes shall be made of unplasticised polyvinyl chloride (uPVC) material with a nominal diameter of 110mm and be compliant with the Singapore Standard SS:272.

5.3.6 In addition to the requirements set out in paragraphs 5.3.1 to 5.3.5, all underground pipes shall be provided in accordance with the requirements set out in chapter 11.

5.3.7 Manholes shall be provided for the underground pipes within each relevant development as follows –

- (a) a manhole shall be constructed at every location where there is effectively an approximately 90° or sharper bend in the direction of the underground pipes; and
- (b) a minimum of 1 manhole must be provided for every 150m segment of underground pipes laid.

5.3.8 The type of manholes to be provided under paragraph 5.3.7 shall be in accordance with Table 5.3.8 based on the highest number of underground pipes entering any one side of the manhole.

Table 5.3.8 Type of manholes to be provided

Highest number of underground pipes entering any one side of the manhole	Type of manhole to be provided
≤ 2	JX2
3 to 6	MX1
7 to 9	MX2
10 to 12	MX3
13 to 16	MX4
17 to 24	MX5

5.3.9 Where the developer or owner is required to provide manholes in the development, the manhole covers shall be designed in accordance with the requirements set out in 11.6.

5.3.10 In addition to the requirements set out in paragraphs 5.3.7 to 5.3.9, all manholes shall be provided in accordance with the requirements set out in chapter 11.

5.4 Provision of lead-in pipes and underground pipes for individual landed dwelling-houses

5.4.1 Every landed dwelling-house shall be provided, at the minimum, with –

- (a) 2 lead-in pipes which shall extend from the gate pillar of the house to the new abutting road to be constructed by the developer, and connect from there to the nearest manhole provided in accordance with paragraph 5.3 (referred to as the “First Lead-In Pipe” and “Second Lead-In Pipe” respectively); and
- (b) 2 underground pipes which shall run from the gate pillar of the house into the house, terminating at the utility room or closet (referred to as the “First Underground Pipe” and “Second Underground Pipe” respectively).

5.4.2 For the purposes of paragraph 5.4.1, all lead-in pipes and underground pipes shall be made of unplasticised polyvinyl chloride (uPVC) material with a nominal diameter of 50mm and be compliant with the Singapore Standard SS:141 Class C.

5.4.3 In addition to the requirements set out in paragraphs 5.4.1 and 5.4.2, all lead-in pipes and underground pipes shall be provided in accordance with the requirements set out in chapter 11.

5.5 Provision of cables in the underground pipes

5.5.1 With regard to the underground pipes referred to in paragraph 5.4.1 –

- (a) a minimum of 1 4-core optical fibre cable complying with ITU-T G.652.D specifications shall be provided in the First Underground Pipe, which shall terminate into a fibre termination point with 4 sets of SC/APC connectors at one end (which may be located in the utility room or closet) and into a fibre termination point with 4 sets of SC/APC connectors located in the gate pillar at the other end. The 4-core optical fibre cable, SC/APC connectors and fibre

termination points shall be provided in accordance with the requirements set out in chapter 15; and

- (b) 1 draw rope shall be provided in the Second Underground Pipe.

5.6 Provision of internal telecommunication wiring

5.6.1 Every landed dwelling-house shall be provided, at the minimum, with –

- (a) RG6 coaxial cable(s) of a number equal to the total number of living room(s) and bedroom(s), which shall terminate into the output of a multi-way splitter (which may be located in the utility room or closet) at one end and into an F-type TV outlet in each of the living room(s) and bedroom(s) at the other end. The RG6 coaxial cable(s) shall be provided in accordance with the requirements set out in chapter 14;
- (b) 1 RG6 coaxial cable, which shall terminate into the input of the splitter (which may be located in the utility room or closet) at one end, and into an IEC 61169-2 coaxial connector in the living room. This RG6 coaxial cable and IEC 61169-2 coaxial connector shall be located at the opposite wall of the TV outlet described in paragraph 5.6.1 (a), and shall be near a window, to enable the installation of an indoor antenna. The RG6 coaxial cable shall be provided in accordance with the requirements set out in chapter 14; and
- (c) unshielded twisted pair cable(s) (Category 6 or better) complying with TIA 568-C specifications of a number equal to the total number of specified location(s) within the landed dwelling-house, as set out in Table 5.6.1 below, which shall terminate into an RJ45 patch panel (which may be located in the utility room or closet) at one end, and into an RJ45 outlet in each of the specified location(s) at the other end within the landed dwelling-house. The length of each unshielded twisted pair cable shall not exceed 90m.

Table 5.6.1 Number of unshielded twisted pair cable(s) to be provided

Location within landed dwelling-house	Number of unshielded twisted pair cable(s) (Category 6 or better) per location
Living room	2
Master bedroom	2
Kitchen	1
Bedroom(s)	1
Above the main entrance	1
Ceiling or high along the wall of the living room	1

- 5.6.2 The developer or owner shall ensure that the installation of all cables required to be provided under this Code is only performed by licensed telecommunication internal wiring contractors.

5.7 Provision of electrical switch socket outlet

- 5.7.1 Every landed dwelling-house shall be provided with a minimum of two (2) 13A electrical switch socket outlets which shall be placed adjacent to the fibre termination point (which may be located in the utility room or closet) referred to in paragraph 5.5.1(a).
- 5.7.2 Every outlet referred to in paragraph 5.6.1 shall be placed adjacent to a 13A electrical switch socket outlet.

5.8 Relevant space and facilities to be ready 6 months prior to the date of issuance of Temporary Occupation Permit

- 5.8.1 Where the developer or owner wishes to have telecommunications services provided to the development commencing from the date of issuance of the Temporary Occupation Permit by the relevant authority ("TOP Date"), the developer or owner shall ensure that the relevant space and facilities (e.g. underground and lead-in pipes) are ready for use by the licensees at least 6 months before the TOP Date.

5.9 Obligation to provide, maintain and grant the use of, and access to, space and facilities

- 5.9.1 The developer or owner shall comply with the requirements specified in paragraphs 2.3 to 2.6 of chapter 2, which shall apply mutatis mutandis to the space and facilities required to be provided under this chapter.

CHAPTER 6 DEVELOPMENT CONSISTING OF 2 OR MORE STRATA LANDED DWELLING-HOUSES

6.1 Application of this chapter

- 6.1.1 This chapter specifies the space and facilities to be provided for a development consisting of 2 or more strata landed dwelling-houses. IMDA reserves the right to require any developer or owner to provide additional space and facilities, to meet the demand for telecommunication services where necessary.
- 6.1.2 If the relevant development consists of more than 200 strata landed dwelling-houses, the developer or owner shall consult IMDA on the space and facilities to be provided and comply with such requirements as may be imposed by IMDA.

6.2 Provision of the main distribution frame room

- 6.2.1 A main distribution frame room shall be provided in every relevant development.
- 6.2.2 Where –
- (a) there is no basement level or a single basement level, the main distribution frame room shall be located on the first or second storey of the relevant development; and
 - (b) there are multiple basement levels, the main distribution frame room shall be located –
 - (i) on the first or second storey; or
 - (ii) on the uppermost basement level provided that –
 - (A) in the event of flooding in the main distribution frame room leading to an outage in the provision of telecommunication services supplied to the development, the developer or owner shall bear all costs incurred by the relevant licensee in restoring the telecommunication services in the development except that where the relevant licensee is restoring such services to the development and external properties, the developer or owner shall only be obliged to bear a reasonable proportion of such costs attributable to the provision of telecommunication services to the development;
 - (B) in the event of flooding in the main distribution frame room leading to damage caused to any installation, plant or system of any licensee by the flooding, the developer or owner shall bear all costs incurred by the relevant licensee in replacing such damaged installation, plant or system of the licensee except that where such damaged installation, plant or system is also deployed by the licensee to serve external properties, the developer or owner shall only be obliged to bear a reasonable proportion of such costs attributable to the provision of telecommunication services to the development; and

- (C) in the event of flooding in the main distribution frame room leading to an outage in the provision of telecommunication services supplied to the development and/or damage caused to any licensee's installation, plant or system, the developer or owner shall –
- (I) promptly notify the residents of the development that telecommunication services may be affected as a result of such event; and
- (II) relocate the main distribution frame room to another location in the first or second storey of the development and bear all costs in connection therewith except that where the installation, plant or system is deployed by the licensee in the main distribution frame room to serve external properties, the developer or owner shall only be obliged to bear a reasonable proportion of such costs attributable to the provision of telecommunication services to the development.

6.2.3 The size of the main distribution frame room to be provided under paragraph 6.2.1 shall be based on the total number of strata landed dwelling-houses in the relevant development as specified in Table 6.2.3.

Table 6.2.3 Size of main distribution frame room to be provided in each relevant development

Total number of strata landed dwelling-houses in the development	Minimum floor area of main distribution frame room (m ²)	Minimum height of main distribution frame room (m)
2 – 10	4	3.5
11 – 20	5	
21 – 30	6	
31 – 60	8	
61 – 120	12	
121 – 200	16	

6.2.4 Where the floor area to be provided for the main distribution frame room is 6m² and below, the minimum width of the main distribution frame room shall be 2m. The ratio of the length and width to be provided for a main distribution frame room with a floor area of more than 6m² shall be between 1:1 and 2:1.

6.2.5 The developer or owner shall provide for ventilation of the main distribution frame room by way of louvres and, where necessary, exhaust fans in accordance with the requirements set out in chapter 12.

6.2.6 Where a relevant development consists of a total of up to 30 strata landed dwelling-houses –

- (a) 3 sets of electrical distribution panels operating on 230V, single phase, 50 Hz power supply connecting to the switch socket outlets; and
- (b) 20A isolators

shall be provided in the main distribution frame room in accordance with paragraphs 6.2.8 and 6.2.9.

- 6.2.7 Where a relevant development consists of a total of more than 30 but up to 200 strata landed dwelling-houses –
- (a) 3 sets of electrical distribution panels operating on 230V, single phase, 50 Hz power supply connecting to the switch socket outlets; and
 - (b) 30A isolators
- shall be provided in the main distribution frame room in accordance with paragraphs 6.2.8 and 6.2.9.
- 6.2.8 Every electrical distribution panel shall contain –
- (a) a 30mA residual current circuit breaker of appropriate electrical current rating and miniature circuit breakers for final circuit connections, to facilitate the installation of electrical meters;
 - (b) 2 spare 20A miniature circuit breakers; and
 - (c) a single-line diagram in each panel.
- 6.2.9 Switch socket outlets and isolators shall be provided in the main distribution frame room in accordance with the quantities specified in Table 6.2.9 which are to be distributed evenly among the 3 sets of electrical distribution panels.

Table 6.2.9 Number of switch socket outlets and isolators to be provided in the main distribution frame room of each relevant development

Total number of strata landed dwelling-houses in the development	Minimum number of switch socket outlets to be provided in main distribution frame room	Minimum number of isolators to be provided in the main distribution frame room
30 or below	3 x 2-gang 13A	3 x 20A
31 – 200	3 x 2-gang 13A	3 x 30A

- 6.2.10 Where a standby power generator is provided in the relevant development, the power supply to the main distribution frame room shall be connected to such standby power generator.
- 6.2.11 Where a standby power generator is not provided in the relevant development, the 20A or 30A isolators (as the case may be) in the main distribution frame room shall be connected to power sockets for connection to portable power generators and equipped with a manually activated switch to effect the changeover.
- 6.2.12 Natural and/or electrical lighting shall be provided in the main distribution frame room.
- 6.2.13 A clean earth of 1Ω or less (without the use of salt) shall be provided for the exclusive use of licensees' installation or plant in the main distribution frame room. The clean earth shall be connected directly to –
- (a) an independent earth electrode system; and
 - (b) the development's electrical safety earth system.

- 6.2.14 Where a relevant development consists of a total of up to 120 strata landed dwelling-houses, the clean earth that is provided pursuant to paragraph 6.2.13 shall be in the form of a copper earth bar of at least 300mm in length, 8mm in width and 5mm in thickness, with screw holes that are 6mm in diameter.
- 6.2.15 Where a relevant development consists of a total of more than 120 but up to 200 strata landed dwelling-houses, the clean earth that is provided pursuant to paragraph 6.2.13 shall be in the form of a copper earth bar of at least 600 mm in length, 8mm in width and 5mm in thickness, with screw holes that are 6mm in diameter.
- 6.2.16 In addition to the requirements set out in paragraphs 6.2.1 to 6.2.15, the main distribution frame room shall be provided in accordance with the requirements set out in chapter 12.

6.3 Provision of lead-in pipes, underground pipes and manholes

- 6.3.1 8 continuous lead-in pipes and underground pipes shall be provided for the relevant development as follows –
- (a) the lead-in pipes shall extend from the boundary of the development to the abutting road, to a point 1 m beyond the roadside drain located immediately outside the development; and
 - (b) the underground pipes shall connect from the lead-in pipes at the boundary of the development and run to the retaining wall of the development if there is any basement level in the development, or to the main distribution frame room if there is no basement level in the development.
- 6.3.2 Where underground pipes are provided to the main distribution frame room, such pipes shall enter the room in a formation of 2 rows x 4 pipes.
- 6.3.3 For the purposes of paragraph 6.3.1, all lead-in pipes and underground pipes shall be made of unplasticised polyvinyl chloride (uPVC) material with a nominal diameter of 110mm and be compliant with the Singapore Standard SS:272.
- 6.3.4 A cable sealing module system shall be installed at the retaining wall of the relevant development to prevent any ingress of water flowing from the underground pipes into the basement.
- 6.3.5 In addition to the requirements set out in paragraphs 6.3.1 to 6.3.4, all lead-in pipes and underground pipes shall be provided in accordance with the requirements set out in chapter 11.
- 6.3.6 Manholes shall be provided in each relevant development as follows –
- (a) a manhole shall be constructed at every location where there is effectively an approximately 90° or sharper bend in the direction of the underground pipes; and
 - (b) a minimum of 1 manhole must be provided for every 150m segment of underground pipes laid.
- 6.3.7 The manholes to be provided under paragraph 6.3.6 shall be of type MX2.

6.3.8 Where the developer or owner is required to provide manholes in the development, the manhole covers shall be designed in accordance with the requirements set out in 11.6.

6.3.9 In addition to the requirements set out in paragraphs 6.3.6 to 6.3.8, all manholes shall be provided in accordance with the requirements set out in chapter 11.

6.4 Provision of cable trays from the retaining wall to the main distribution frame room where there is basement level in the relevant development

6.4.1 A minimum of 2 cable trays (for telecommunication) shall be provided from the retaining wall of the relevant development to the main distribution frame room.

6.4.2 The total width of these 2 cable trays shall cover the total cross-sectional width of the underground pipes terminating at the retaining wall.

6.5 Provision of cable trays from the main distribution frame room to each house

6.5.1 A minimum of 2 cable trays (for telecommunication) with a minimum width of 200mm shall be provided from the main distribution frame room to each strata landed dwelling-house.

6.6 Provision of conduits to each house

6.6.1 Every strata landed dwelling-house in the relevant development shall be provided, at the minimum, with 2 conduits of a minimum size of 20mm in diameter (for telecommunication) which shall run from the location where the cable trays referred to in paragraph 6.5 terminate, into each strata landed dwelling-house, and terminating at the utility room or closet (referred to as the "First Conduit" and "Second Conduit" respectively).

6.7 Provision of cables in the conduits

6.7.1 With regard to the conduits referred to in paragraph 6.6.1 –

(a) a minimum of 1 4-core optical fibre cable complying with ITU-T G.652.D specifications shall be provided in the First Conduit, which shall terminate into a fibre termination point with 4 sets of SC/APC connectors at one end (which may be located in the utility room or closet) and into a fibre termination point with 4 sets of SC/APC connectors located in the gate pillar/telecommunication riser at the other end. The 4-core optical fibre cable, SC/APC connectors and fibre termination points shall be provided in accordance with the requirements set out in chapter 15; and

(b) 1 draw rope shall be provided in the Second Conduit.

6.8 Provision of internal telecommunication wiring

6.8.1 Every strata landed dwelling-house shall be provided, at the minimum, with –

- (a) RG6 coaxial cable(s) of a number equal to the total number of living room(s) and bedroom(s), which shall terminate into the output of a multi-way splitter (which may be located in the utility room or closet) at one end and into an F-type TV outlet in each of the living room(s) and bedroom(s) at the other end. The RG6 coaxial cable(s) shall be provided in accordance with the requirements set out in chapter 14;
- (b) 1 RG6 coaxial cable, which shall terminate into the input of the splitter (which may be located in the utility room or closet) at one end, and into an IEC 61169-2 coaxial connector in the living room. This RG6 coaxial cable and IEC 61169-2 coaxial connector shall be located at the opposite wall of the TV outlet described in paragraph 6.8.1 (a), and shall be near a window, to enable the installation of an indoor antenna. The RG6 coaxial cable shall be provided in accordance with the requirements set out in chapter 14; and
- (c) unshielded twisted pair cable(s) (Category 6 or better) complying with TIA 568-C specifications of a number equal to the total number of specified location(s) within the landed dwelling-house, as set out in Table 6.8.1 below, which shall terminate into an RJ45 patch panel (which may be located in the utility room or closet) at one end, and into an RJ45 outlet in each of the specified location(s) at the other end within the landed dwelling-house. The length of each unshielded twisted pair cable shall not exceed 90m.

Table 6.8.1 Number of unshielded twisted pair cable(s) to be provided

Location within landed dwelling-house	Number of unshielded twisted pair cable(s) (Category 6 or better) per location
Living room	2
Master bedroom	2
Kitchen	1
Bedroom(s)	1
Above the main entrance	1
Ceiling or high along the wall of the living room	1

6.8.2 The developer or owner shall ensure that the installation of all cables required to be provided under this Code is only performed by licensed telecommunication internal wiring contractors.

6.9 Provision of electrical switch socket outlet

6.9.1 Every strata landed dwelling-house shall be provided with a minimum of two (2) 13A electrical switch socket outlets which shall be placed adjacent to the fibre termination point (which may be located in the utility room or closet) referred to in paragraph 6.7.1(a).

6.9.2 Every outlet referred to in paragraph 6.8.1 shall be placed adjacent to a 13A electrical switch socket outlet.

6.10 Relevant space and facilities to be ready 6 months prior to the date of issuance of Temporary Occupation Permit by the relevant authority

6.10.1 Where the developer or owner wishes to have telecommunication services provided to the development commencing from the TOP Date, the developer or owner shall ensure that the relevant space and facilities (e.g. main distribution frame room, lead-in pipes and cable trays) are ready for use by the licensees at least 6 months before the TOP Date.

6.11 Obligation to provide, maintain and grant the use of, and access to, space and facilities

6.11.1 The developer or owner shall comply with the requirements specified in paragraphs 2.3 to 2.6 of chapter 2, which shall apply mutatis mutandis to the space and facilities required to be provided under this chapter.

CHAPTER 7 DEVELOPMENT CONSISTING OF 1 OR MORE MULTI-STOREY RESIDENTIAL BUILDINGS

7.1 Application of this chapter

- 7.1.1 This chapter specifies the space and facilities to be provided for a development consisting of 1 or more multi-storey residential buildings. IMDA reserves the right to require any developer or owner to provide additional space and facilities, to meet the demand for telecommunication services where necessary.
- 7.1.2 If the relevant development consists of more than 1500 residential units, the developer or owner shall consult IMDA on the space and facilities to be provided and comply with such requirements as may be imposed by IMDA.

7.2 Provision of the main distribution frame room

- 7.2.1 A minimum of 1 main distribution frame room shall be provided in every relevant development.
- 7.2.2 Where –
- (a) there is no basement level or a single basement level, the main distribution frame room shall be located on the first or second storey of the relevant development; and
 - (b) there are multiple basement levels, the main distribution frame room shall be located –
 - (i) on the first or second storey; or
 - (ii) on the uppermost basement level provided that –
 - (A) in the event of flooding in the main distribution frame room leading to an outage in the provision of telecommunication services supplied to the development, the developer or owner shall bear all costs incurred by the relevant licensee in restoring the telecommunication services in the development except that where the relevant licensee is restoring such services to the development and external properties, the developer or owner shall only be obliged to bear a reasonable proportion of such costs attributable to the provision of telecommunication services to the development;
 - (B) in the event of flooding in the main distribution frame leading to damage caused to any installation, plant or system of any licensee by the flooding, the developer or owner shall bear all costs incurred by the relevant licensee in replacing such damaged installation, plant or system of the licensee except that where such damaged installation, plant or system is also deployed by the licensee to serve external properties, the developer or owner shall only be obliged to bear a reasonable proportion of such costs attributable to the provision of telecommunication services to the development; and

- (C) in the event of flooding in the main distribution frame room leading to an outage in the provision of telecommunication services supplied to the development and/or damage caused to any licensee's installation, plant or system, the developer or owner shall –
- (I) promptly notify the residents of the development that telecommunication services may be affected as a result of such event; and
- (II) relocate the main distribution frame room to another location in the first or second storey of the development and bear all costs in connection therewith except that where the installation, plant or system is deployed by the licensee in the main distribution frame room to serve external properties, the developer or owner shall only be obliged to bear a reasonable proportion of such costs attributable to the provision of telecommunication services to the development.

7.2.3 The size of the main distribution frame room to be provided under paragraph 7.2.1 shall be based on the total number of residential units in the relevant development, as specified in Table 7.2.3.

Table 7.2.3 Size of main distribution frame room to be provided in each relevant development

Total number of residential units in the development	Minimum floor area of the main distribution frame room (m ²)	Minimum height of the main distribution frame room (m)
2 - 10	4	3.5
11 - 20	5	
21 - 30	6	
31 - 60	8	
61 - 120	12	
121 - 200	16	
201 - 400	20	
401 - 600	30	
601 - 800	42	
801 - 1000	49	
1001 - 1500	56	

7.2.4 Where the floor area to be provided for the main distribution frame room is 6m² and below, the minimum width of the main distribution frame room shall be 2m. The ratio of the length and width to be provided for a main distribution frame room with a floor area of more than 6m² shall be between 1:1 and 2:1.

7.2.5 The developer or owner shall provide for ventilation of the main distribution frame room by way of louvres and, where necessary, exhaust fans in accordance with the requirements set out in chapter 12.

7.2.6 Where a relevant development consists of a total of up to 30 residential units –

- (a) 3 sets of electrical distribution panels operating on 230V, single phase, 50Hz power supply connecting to the switch socket outlets; and

(b) 20A isolators

shall be provided in every main distribution frame room in accordance with paragraphs 7.2.8 and 7.2.9.

7.2.7 Where a relevant development consists of a total of more than 30 but up to 1500 residential units –

(a) 3 sets of electrical distribution panels operating on 230V, single phase, 50Hz power supply connecting to switch socket outlets; and

(b) 30A isolators

shall be provided in every main distribution frame room in accordance with paragraphs 7.2.8 and 7.2.9.

7.2.8 Every electrical distribution panel shall contain –

(a) a 30mA residual current circuit breaker of appropriate electrical current rating and miniature circuit breakers for final circuit connections, to facilitate the installation of electrical meters;

(b) 2 spare 20A miniature circuit breakers; and

(c) a single-line diagram in each panel.

7.2.9 Switch socket outlets and isolators shall be provided in every main distribution frame room in accordance with the quantities specified in Table 7.2.9 which are to be distributed evenly among the 3 sets of electrical distribution panels.

Table 7.2.9 Number of switch socket outlets and isolators to be provided in the main distribution frame room of each relevant development

Total number of residential units in the development	Minimum number of switch socket outlets to be provided in the main distribution frame room	Minimum number of isolators to be provided in the main distribution frame room
30 or below	3 x 2-gang 13A	3 x 20A
31 to 200	3 x 2-gang 13A	3 x 30A
201 to 1500	3 x 2-gang 13A	6 x 30A

7.2.10 Where a standby power generator is provided in the relevant development, the power supply to the main distribution frame room shall be connected to such standby power generator.

7.2.11 Where a standby power generator is not provided in the relevant development, the 20A or 30A isolators (as the case may be) in the main distribution frame room shall be connected to power sockets for connection to portable power generators and equipped with a manually activated switch to effect the changeover.

7.2.12 Natural and/or electrical lighting shall be provided in the main distribution frame room.

- 7.2.13 A clean earth of 1Ω or less (without the use of salt) shall be provided for the exclusive use of licensees' installation, plant or system in the main distribution frame room. The clean earth shall be connected directly to –
- (i) an independent earth electrode system; and
 - (ii) the development's electrical safety earth system.
- 7.2.14 Where a relevant development consists a total of up to 120 residential units, the clean earth that is provided pursuant to paragraph 7.2.13 shall be in the form of a copper earth bar of at least 300mm in length, 8mm in width and 5mm in thickness, with screw holes that are 6mm in diameter.
- 7.2.15 Where a relevant development consists a total of more than 120 but up to 1500 residential units, the clean earth that is provided pursuant to paragraph 7.2.13 shall be in the form of a copper earth bar of at least 600mm in length, 8mm in width and 5mm in thickness, with screw holes that are 6mm in diameter.
- 7.2.16 In addition to the requirements set out in paragraphs 7.2.1 to 7.2.15, the main distribution frame room shall be provided in accordance with the requirements set out in chapter 12.

7.3 **Provision of lead-in pipes, underground pipes and manholes where there is no basement in the relevant development**

- 7.3.1 Continuous lead-in pipes and underground pipes shall be provided for the relevant development as follows –
- (a) the lead-in pipes shall extend from the boundary of the development to the abutting road, to a point 1m beyond the roadside drain located immediately outside the development; and
 - (b) the underground pipes shall connect from the lead-in pipes at the boundary of the development and run to the main distribution frame room.
- 7.3.2 The number of lead-in pipes and underground pipes to be provided under paragraph 7.3.1 shall be in accordance with the quantities specified in Table 7.3.2.

Table 7.3.2 Number of lead-in pipes and underground pipes to be provided for the relevant development with no basement

Total number of residential units in the development	Minimum number of lead-in & underground pipes to be provided
≤ 60	6
61 - 200	8
201 - 400	10
401 - 600	12
601 - 800	14
801 - 1000	16
1001 - 1500	18

- 7.3.3 The underground pipes shall enter the main distribution frame room in accordance with the formation specified in Table 7.3.3.

Table 7.3.3 Pipe formation in the main distribution frame room

Total number of residential units in the development	Pipe formation in the main distribution frame room
≤ 60	2 x 3
61 - 200	2 x 4
201 - 400	2 x 5
401 - 600	2 x 6
601 - 800	2 x 7
801 - 1000	2 x 8
1001 - 1500	2 x 9

- 7.3.4 For the purposes of paragraph 7.3.1, all lead-in pipes and underground pipes shall be made of unplasticised polyvinyl chloride (uPVC) material with a nominal diameter of 110mm and be compliant with the Singapore Standard SS:272.
- 7.3.5 In addition to the requirements set out in paragraphs 7.3.1 to 7.3.4, all lead-in pipes and underground pipes shall be provided in accordance with the requirements set out in chapter 11.
- 7.3.6 Manholes shall be provided in each relevant development as follows –
- a manhole shall be constructed at every location where there is effectively an approximately 90° or sharper bend in the direction of the underground pipes; and
 - a minimum of 1 manhole must be provided for every 150m segment of underground pipes laid.
- 7.3.7 The type of manhole to be provided under paragraph 7.3.6 shall be in accordance with Table 7.3.7 below based on the highest number of underground pipes entering any one side of the manhole.

Table 7.3.7 Type of manhole to be provided

Highest number of underground pipes entering any one side of the manhole	Type of manhole to be provided
≤ 2	JX2
3 - 6	MX1
7 - 9	MX2
10 - 12	MX3
13 - 16	MX4
17 - 24	MX5

- 7.3.8 Where the developer or owner is required to provide manholes in the development, the manhole covers shall be designed in accordance with requirements set out in 11.6.
- 7.3.9 In addition to the requirements set out in paragraphs 7.3.6 to 7.3.8, all manholes shall be provided in accordance with the requirements set out in chapter 11.

7.4 **Provision of lead-in pipes, underground pipes, manholes and cable trays where there is 1 or more basement level(s) in the development**

7.4.1 Continuous lead-in pipes and underground pipes shall be provided for the relevant development as follows –

- (a) the lead-in pipes shall extend from the boundary of the development to the abutting road, to a point 1m beyond the roadside drain located immediately outside the development; and
- (b) the underground pipes shall connect from the lead-in pipes at the boundary of the development and run to the retaining wall of the development.

7.4.2 The number of lead-in pipes and underground pipes to be provided under paragraph 7.4.1 shall be in accordance with the quantities specified in Table 7.4.2 below.

Table 7.4.2 Number of lead-in pipes and underground pipes to be provided for the relevant development with 1 or more basement level(s)

Total number of residential units in the development	Minimum number of lead-in & underground pipes to be provided
≤ 60	6
61 - 200	8
201 - 400	10
401 - 600	12
601 - 800	14
801 - 1000	16
1001 - 1500	18

7.4.3 For the purposes of paragraph 7.4.1, all lead-in pipes and underground pipes shall be made of unplasticised polyvinyl chloride (uPVC) material with a nominal diameter of 110mm and be compliant with the Singapore Standard SS:272.

7.4.4 A cable sealing module system shall be installed at the retaining wall of the relevant development to prevent any ingress of water flowing from the underground pipes into the basement.

7.4.5 In addition to the requirements set out in paragraphs 7.4.1 to 7.4.4, all lead-in pipes and underground pipes shall be provided in accordance with the requirements set out in chapter 11.

7.4.6 Manholes shall be provided in each relevant development as follows –

- (a) a manhole shall be constructed at every location where there is effectively an approximately 90° or sharper bend in the direction of the underground pipes; and
- (b) at the minimum, 1 manhole must be provided for every 150m segment of underground pipes laid.

7.4.7 The type of manhole to be provided under paragraph 7.4.6 shall be in accordance with Table 7.4.7 below based on the highest number of underground pipes entering any one side of the manhole.

Table 7.4.7 Type of manhole to be provided

Highest number of underground pipes entering any one side of the manhole	Type of manhole to be provided
≤ 2	JX2
3 - 6	MX1
7 - 9	MX2
10 - 12	MX3
13 -16	MX4
17 - 24	MX5

- 7.4.8 Where the developer or owner is required to provide manholes in the development, the manhole covers shall be designed in accordance with the requirements set out in 11.6.
- 7.4.9 In addition to the requirements set out in paragraphs 7.4.6 to 7.4.9, all manholes shall be provided in accordance with the requirements set out in chapter 11.
- 7.4.10 A minimum of 2 cable trays (for telecommunication) shall be provided from the retaining wall of the relevant development to the main distribution frame room.
- 7.4.11 The total width of these 2 cable trays shall cover the total cross-sectional width of the underground pipes terminating at the retaining wall.

7.5 Provision of telecommunication equipment rooms

- 7.5.1 In addition to the main distribution frame room specified in paragraph 7.2, a telecommunication equipment room shall be provided in every multi-storey residential building within a relevant development that has a total of more than 10 residential units, except where such building already houses a main distribution frame room.
- 7.5.2 Where –
- (a) there is no basement level or a single basement level in the multi-storey residential building, the telecommunication equipment room shall be located on the first or second storey of the multi-storey residential building; or
 - (b) there are multiple basement levels, the telecommunication equipment room shall be located:
 - (i) on the first or second storey; or
 - (ii) on the uppermost basement level provided that:
 - (A) in the event of flooding in the telecommunication equipment room leading to an outage in the provision of telecommunication services supplied to the relevant multi-storey residential building(s), the developer or owner shall bear all costs incurred by the relevant licensee in restoring the telecommunication services except that where the relevant licensee is restoring such services to the development and external properties, the developer or owner shall

only be obliged to bear a reasonable proportion of such costs to the extent that such restoration affects services provided to the development;

- (B) in the event of flooding in the telecommunication equipment room leading to damage caused to any installation, plant or system of any licensee by the flooding, the developer or owner shall bear all costs incurred by the relevant licensee in replacing such damaged installation, plant or system of the licensee except that where such damaged installation, plant or system is also deployed by the licensee to serve external properties, the developer or owner shall only be obliged to bear a reasonable proportion of such costs attributable to the provision of telecommunication services to serve the development; and
- (C) in the event of flooding in the telecommunication equipment room leading to an outage in the provision of telecommunication services supplied to the relevant multi-storey residential building(s) and/or damage caused to any licensee's installation, plant or system, the developer or owner shall:
 - (I) promptly notify the residents of the development that telecommunication services may be affected as a result of such event; and
 - (II) relocate the telecommunication equipment room to another location in the first or second storey of the relevant multi-storey residential building(s) and bear all costs in connection therewith except that where the installation, plant or system is deployed by the licensee at the telecommunication equipment room to serve external properties, the developer or owner shall only be obliged to bear a reasonable proportion of such costs attributable to the provision of telecommunication services to the development.

7.5.3 The size of the telecommunication equipment room to be provided under paragraph 7.5.1 shall be based on the total number of residential units in the multi-storey residential building, as specified in Table 7.5.3.

Table 7.5.3 Size of the telecommunication equipment room to be provided in each multi-storey residential building

Total number of residential units in the multi-storey residential building	Minimum floor area of the telecommunication equipment room (m ²)	Minimum height of the telecommunication equipment room (m)
11 - 30	4	3.5
31 - 60	5	
61 - 120	6	
121 - 300	8	
301 - 600	10	

7.5.4 Where the floor area to be provided for the telecommunication equipment room is 6m² and below, the minimum width of the telecommunication equipment room shall be 2m.

The ratio of the length and width to be provided for a telecommunication equipment room with a floor area of more than 8m² shall be between 1:1 and 2:1.

7.5.5 Where –

- (a) there is no basement level in the multi-storey residential building, the developer or owner shall provide underground pipes for each telecommunication equipment room in accordance with paragraphs 7.5.6, 7.5.7 and 7.5.9; or
- (b) there is 1 or more basement level(s) in the multi-storey residential building, the developer or owner shall provide –
 - (i) underground pipes for each telecommunication equipment room in accordance with paragraphs 7.5.6, 7.5.7 and 7.5.9; or
 - (ii) a minimum of 2 cable trays for each telecommunication equipment room in accordance with paragraph 7.5.10.

7.5.6 The underground pipes referred to in paragraph 7.5.5 shall be in accordance with the quantities specified in Table 7.5.6 below.

Table 7.5.6 Number of underground pipes to be provided for the telecommunication equipment room

Total number of residential units in the multi-storey building	Minimum number of underground pipes to be provided
11 - 60	6
61 - 200	8
201 - 400	10
401 - 600	12

7.5.7 When entering the telecommunication equipment room, the underground pipes referred to in paragraph 7.5.6 shall be configured in accordance with the formation specified in Table 7.5.7.

Table 7.5.7 Pipe formation in the telecommunication equipment room

Total number of residential units in the in the multi-storey residential building	Pipe formation in the telecommunication equipment room
11 - 60	2 x 3
61 - 200	2 x 4
201 - 400	2 x 5
401 - 600	2 x 6

7.5.8 The developer or owner may consult IMDA on the number of underground pipes to be provided between the main distribution frame room and the telecommunication equipment room (save for underground pipes to be provided for each telecommunication equipment room which shall be provided in accordance with paragraph 7.5.5), and shall comply with such requirements as may be imposed by IMDA.

- 7.5.9 For the purposes of paragraph 7.5, all underground pipes shall be made of unplasticised polyvinyl chloride (uPVC) material with a nominal diameter of 110mm and be compliant with the Singapore Standard SS:272.
- 7.5.10 The developer or owner may consult IMDA on the size of the 2 cable trays (for telecommunication) to be provided between the main distribution frame room and the telecommunication equipment room, and shall comply with such requirements as may be imposed by IMDA.
- 7.5.11 The developer or owner shall provide for ventilation of the telecommunication equipment room by way of louvres and, where necessary, exhaust fans in accordance with the requirements set out in chapter 12.
- 7.5.12 2 sets of electrical distribution panels operating on 230V, single phase, 50Hz power supply connecting to the switch socket outlets shall be provided in the telecommunication equipment room in accordance with paragraphs 7.5.13 and 7.5.14.
- 7.5.13 Every electrical distribution panel shall contain –
- (a) a 30mA residual current circuit breaker of appropriate electrical current rating and miniature circuit breakers for final circuit connections, to facilitate the installation of electrical meters;
 - (b) 2 spare 20A miniature circuit breakers; and
 - (c) a single-line diagram in each panel.
- 7.5.14 Two (2) 2-gang 13A switch socket outlets and two (2) 20A isolators shall be provided in the telecommunication equipment room which are to be distributed evenly between the 2 sets of electrical distribution panels.
- 7.5.15 Where a standby power generator is provided in the relevant development, the power supply to the telecommunication equipment room shall be connected to such standby power generator.
- 7.5.16 Natural and/or electrical lighting shall be provided in the telecommunication equipment room.
- 7.5.17 A clean earth of 1Ω or less (without the use of salt) shall be provided for the exclusive use of licensees' installation, plant or system in the telecommunication equipment room. The clean earth shall be connected directly to –
- (a) an independent earth electrode system; and
 - (b) the development's electrical safety earth system.
- 7.5.18 The clean earth that is provided pursuant to paragraph 7.5.17 shall be in the form of a copper earth bar of at least 300mm in length, 8mm in width and 5mm in thickness, with screw holes that are 6mm in diameter.
- 7.5.19 In addition to the requirements set out in paragraphs 7.5.1 to 7.5.18, the telecommunication equipment room shall be provided in accordance with the requirements set out in chapter 12.

7.6 Provision of the telecommunication risers

- 7.6.1 Telecommunication risers shall be provided in every residential multi-storey building in the relevant development.
- 7.6.2 The serving radius of each telecommunication riser shall not exceed 40m. Each telecommunication riser shall be labelled as “Telecom Riser” and numbered for easy reference and identification.
- 7.6.3 All telecommunication riser shafts must be constructed in a direct vertical line throughout the building.
- 7.6.4 The dimensions of each telecommunication riser to be provided under paragraph 7.6.1 shall be based on the total number of residential units to be served by the telecommunication riser, as specified in Table 7.6.4.

Table 7.6.4 Dimensions of the telecommunication riser

Total number of residential units served by a telecommunication riser	Minimum dimensions of each telecommunication riser
≤ 30	600 mm (width) x 450 mm (depth)
> 30	800 mm (width) x 600 mm (depth)

- 7.6.5 Every telecommunication riser shall have a door which can be fully opened outwards throughout its entire width for easy access at each floor level. The height of the door shall be at least 2.1m. The width of the door shall be in accordance with the dimensions specified in Table 7.6.5 below.

Table 7.6.5 Minimum width of door of the telecommunication riser

Minimum dimensions of each telecommunication riser	Minimum width of each door of the telecommunication riser
600 mm (width) x 450 mm (depth)	500 mm
800 mm (width) x 600 mm (depth)	600 mm

- 7.6.6 All doors of the telecommunication risers shall be locked.
- 7.6.7 A minimum of 2 cable trays (for telecommunication) shall be provided in each telecommunication riser from the first storey or basement to the topmost level of every multi-storey residential building.
- 7.6.8 The 2 cable trays (for telecommunication) shall be installed opposite each other on the side walls of the telecommunication riser.
- 7.6.9 For the purposes of paragraph 7.6.7, the 2 cable trays (for telecommunication) shall be provided in accordance with the requirements specified in Table 7.6.9.

Table 7.6.9 Width of cable trays in each telecommunication riser

	Minimum width of each cable tray where the telecommunication riser has a side wall depth of 450 mm	Minimum width of each cable tray where the telecommunication riser has a side wall depth of 600 mm
Cable tray for buildings up to and including 25 storeys	200 mm	300 mm
Cable tray for buildings more than 25 storeys and up to and including 50 storeys	300 mm	400 mm
Cable tray for buildings more than 50 storeys	To consult IMDA	To consult IMDA

7.6.10 The telecommunication riser openings on every storey in each multi-storey residential building shall be sealed in accordance with the Code of Practice for Fire Precautions in Buildings issued by Singapore Civil Defence Force.

7.6.11 In addition to the requirements set out in paragraphs 7.6.1 to 7.6.10, all telecommunication risers shall be provided in accordance with the requirements set out in chapter 13.

7.7 Provision of cable trays from the main distribution frame room or telecommunication equipment room to each telecommunication riser

7.7.1 A minimum of 2 cable trays (for telecommunication) shall be provided from the main distribution frame room or telecommunication equipment room of each building to each telecommunication riser in accordance with the requirements specified in Table 7.7.1.

Table 7.7.1 Width of cable trays to be provided from the main distribution frame room or telecommunication equipment room to each telecommunication riser

	Minimum width of each cable tray where the telecommunication riser serves \leq 30 residential units	Minimum width of each cable tray where the telecommunication riser serves $>$ 30 residential units
Cable tray (for telecommunication)	300 mm	400 mm

7.8 Provision of conduits from the telecommunication risers to each residential unit

7.8.1 Every residential unit in the relevant development shall be provided, at the minimum, with 2 conduits of a minimum size of 20mm in diameter (for telecommunication) which shall run from the telecommunication riser into the residential unit, and terminating

into the utility room or closet (referred to as the “First Conduit” and “Second Conduit” respectively).

7.9 Provision of cables in the conduits

7.9.1 With regard to the conduits referred to in paragraph 7.8.1 –

- (a) a minimum of 1 4-core optical fibre cable complying with ITU-T G.652.D specifications shall be provided in the First Conduit, which shall terminate into a fibre termination point with 4 sets of SC/APC connectors at one end (which may be located in the utility room or closet) and into a fibre termination point with 4 sets of SC/APC connectors located in the telecommunication riser at the other end. The 4-core optical fibre cable, SC/APC connectors and fibre termination points shall be provided in accordance with the requirements set out in chapter 15; and
- (b) 1 draw rope shall be provided in the Second Conduit.

7.10 Provision of internal telecommunication wiring

7.10.1 Every residential unit shall be provided, at the minimum, with –

- (a) RG6 coaxial cable(s) of a number equal to the total number of living room(s) and bedroom(s), which shall terminate into the output of a multi-way splitter (which may be located in the utility room or closet) at one end and into an F-type TV outlet in each of the living room(s) and bedroom(s) at the other end. The RG6 coaxial cable(s) shall be provided in accordance with the requirements set out in chapter 14;
- (b) 1 RG6 coaxial cable, which shall terminate into the input of the splitter (which may be located in the utility room or closet) at one end, and into an IEC 61169-2 coaxial connector in the living room. This RG6 coaxial cable and IEC 61169-2 coaxial connector shall be located at the opposite wall of the TV outlet described in paragraph 7.10.1 (a), and shall be near a window, to enable the installation of an indoor antenna. The RG6 coaxial cable shall be provided in accordance with the requirements set out in chapter 14; and
- (c) unshielded twisted pair cable(s) (Category 6 or better) complying with TIA 568-C specifications of a number equal to the total number of specified location(s) within the residential unit, as set out in Table 7.10.1 below, which shall terminate into an RJ45 patch panel (which may be located in the utility room or closet) at one end, and into an RJ45 outlet in each of the specified location(s) at the other end within the residential unit. The length of each unshielded twisted pair cable shall not exceed 90m.

Table 7.10.1 Number of unshielded twisted pair cable(s) to be provided

Location within residential unit	Number of unshielded twisted pair cable(s) (Category 6 or better) per location
Living room	2
Master bedroom	2
Kitchen	1
Bedroom(s)	1
Above the main entrance	1
Ceiling or high along the wall of the living room	1

7.10.2 The developer or owner shall ensure that the installation of all cables required to be provided under this Code is only performed by licensed telecommunication internal wiring contractors.

7.11 Provision of electrical switch socket outlet

7.11.1 Every residential unit shall be provided with a minimum of two (2) 13A electrical switch socket outlets which shall be placed adjacent to the fibre termination point (which may be located in the utility room or closet) referred to in paragraph 7.9.1(a).

7.11.2 Every outlet referred to in paragraph 7.10.1 shall be placed adjacent to a 13A electrical switch socket outlet.

7.12 Provision of mobile deployment space

7.12.1 The developer or owner shall provide mobile deployment space in accordance with all the requirements specified in this paragraph 7.12 at its own cost and expense, unless otherwise stated.

7.12.2 As a general principle, the mobile deployment space provided by a developer or owner shall be prioritised to serve the mobile coverage needs of the relevant development. Nevertheless, to enable mobile telecommunication licensees to optimise the use of mobile deployment space to provide mobile coverage to multiple buildings using the same set of installation, plant and systems, mobile telecommunication licensees may, in addition to serving the relevant development, use the mobile deployment space to provide mobile coverage to any land or building located outside of the relevant development. For the avoidance of doubt, no developer or owner shall refuse to provide mobile deployment space on the ground that it will be used by a mobile telecommunication licensee to provide mobile coverage to any external properties in addition to the relevant development.

7.12.3 If the relevant development consists of 80 or more residential units, the developer or owner shall, where required and notified by any mobile telecommunication licensee, provide within a reasonable time, mobile deployment space in accordance with the dimensions specified in Table 7.12.3 based on the total number of residential units in the development. If the relevant development consists of more than 1500 residential units, the developer or owner shall consult IMDA on the mobile deployment space to be provided and comply with such requirements as may be imposed by IMDA.

Table 7.12.3 Mobile deployment space to be provided in each relevant development

Total number of residential units in the development	Mobile deployment space (m ²)	Minimum height of mobile deployment space (m)
	80 - 200	3
201 - 600	36	
601 - 1500	54	
> 1500	To consult IMDA	

- 7.12.4 The amount of mobile deployment space provided by a developer or owner shall be computed based on the footprint (i.e. floor space) occupied by the installation, plant or systems (e.g. antennas, base stations, remote radio units, combiners and power distribution boxes) deployed by a mobile telecommunication licensee at the mobile deployment space.
- 7.12.5 For the avoidance of doubt, the space occupied by facilities required to be installed to serve the installation, plant and systems deployed by a mobile telecommunication licensee at the mobile deployment space (e.g. cable distribution systems and power distribution systems) shall not be counted towards the computation of the mobile deployment space.
- 7.12.6 Where a mobile telecommunication licensee requires any additional space, the mobile telecommunication licensee shall consult with and obtain the approval of the developer or owner for the provision of such additional space, on such prices, terms and conditions as may be agreed between the parties.
- 7.12.7 The developer or owner shall, where required and notified by any mobile telecommunication licensee, within a reasonable time, grant the mobile telecommunication licensee access to all common areas within the relevant development which may reasonably serve as mobile deployment space (including but not limited to building rooftops) to enable the mobile telecommunication licensee to carry out feasibility studies and site surveys to identify suitable mobile deployment spaces.
- 7.12.8 The location of the mobile deployment space to be provided under paragraph 7.12.3 shall be determined by the mobile telecommunication licensee in consultation with the developer or owner, subject to the following –
- (a) where feasible, the mobile deployment space shall be located on the rooftops of buildings to optimise the coverage of the installation, plant or systems to be deployed by the mobile telecommunication licensee;
 - (b) there shall be adequate access and work space provided around equipment sited in the mobile deployment space to reasonably enable the mobile telecommunication licensee to carry out any requisite works in relation to the installation, plant or systems deployed therein;
 - (c) the mobile telecommunication licensee shall, where practicable, take suitable measures to address any reasonable concerns that the developer or owner may have in relation to the aesthetics of the mobile deployment space;

- (d) the mobile deployment space may be split into one (1) or more locations within the relevant development so as to facilitate the provision of public cellular mobile telecommunication services to the whole development, provided that the total amount of mobile deployment space at all locations combined shall not exceed the maximum amounts specified in paragraph 7.12.3;
- (e) the mobile deployment space shall be located at any unused space in the development;
- (f) the mobile deployment space shall not be located in the main distribution frame room or the telecommunication equipment room, unless there is sufficient space available after having fulfilled the space requirements of the main distribution frame room or telecommunication equipment room and there is a clear demarcation of the space designated as mobile deployment space; and
- (g) the mobile deployment space shall not be located in any area that –
 - (i) is susceptible to the risk of flooding;
 - (ii) is directly subject to the discharge of water, steam, fumes, gases or dust;
 - (iii) is within or near a bin centre; and
 - (iv) is not able to withstand a loading of 1.5kN/m² or more; and
 - (v) will subject the installation, plant or systems deployed therein to vibration of more than 0.05 G, where G is the acceleration due to gravity (G=9.81 m/s²).

7.12.9 Where a developer or owner objects to the location of any mobile deployment space selected by the mobile telecommunication licensee, both parties shall co-operate in good faith to resolve the matter in a timely manner, having regard to parameters stated in paragraph 7.12.8. In the event that parties are unable to reach agreement, they may refer the matter to IMDA for a decision which shall be binding on the parties.

7.12.10 Where –

- (a) the developer or owner is responsible for complying with any statutory or regulatory requirements or obtaining any requisite approvals for its provision of the mobile deployment space, the developer or owner shall do so in a timely manner; and
- (b) the mobile telecommunication licensee is responsible for complying with any statutory or regulatory requirements or obtaining any requisite approvals for its use of the mobile deployment space, the developer or owner shall render all necessary assistance as the mobile telecommunication licensee may reasonably require in a timely manner to enable the mobile telecommunication licensee to do so (e.g. providing the developer's or owner's endorsement, where required, on applications submitted by the mobile telecommunication licensee to relevant authorities in connection with the mobile deployment space), save that the mobile telecommunication licensee shall bear the cost and expense for carrying out any actions within its responsibility. Where the mobile telecommunication licensee is responsible for complying with any statutory or

regulatory requirements or obtaining any requisite approvals for its use of the mobile deployment space, the licensee shall do so at its own cost and expense.

7.12.11 Where the mobile telecommunication licensee requires lighting and ventilation to be provided at a mobile deployment space to enable the mobile telecommunication licensee to deploy and operate its installation, plant or system at that location, the developer or owner shall render all necessary access and assistance in a timely manner to facilitate the provision of such lighting and ventilation, save that the mobile telecommunication licensee shall bear the cost and expense for the provision of the necessary lighting and ventilation.

7.12.12 Where the mobile telecommunication licensee requires –

- (a) facilities (e.g. cable distribution system and power distribution system) to be installed to serve its installation, plant or system deployed at the mobile deployment space; or
- (b) works to be carried out in connection with the installation of such facilities and use of the mobile deployment space (e.g. drilling and coring works, and the opening and reinstatement of false ceilings and access panels),

the developer or owner shall provide all necessary access and assistance in a timely manner to facilitate such installation or works by the mobile telecommunication licensee, save that the mobile telecommunication licensee shall bear the cost and expense for the installation of the necessary facilities and the carrying out of the necessary works.

7.12.13 Without prejudice to paragraph 7.12.12, the developer or owner shall ensure that the electrical consumer switch room has sufficient power capacity (up to 32A, 3 phase 50Hz power supply per mobile telecommunication licensee) to supply electricity for the operation of the installation, plant or system deployed by the mobile telecommunication licensee at the mobile deployment space.

7.12.14 Where the developer or owner reasonably desires to use the mobile deployment space for other purposes such that it is necessary for the mobile telecommunication licensee to relocate its installation, plant or system deployed at the mobile deployment space to another location within the relevant development, the developer or owner shall –

- (a) ensure that the alternative location within the relevant development is reasonably fit for the purposes of serving as a mobile deployment space; and
- (b) bear all costs and expenses reasonably incurred by the mobile telecommunication licensee in connection with the relocation of its installation, plant or system,

save that where the developer or owner requires the mobile telecommunication licensee to remove its installation, plant or system due to the need to demolish the building, the mobile telecommunication licensee shall bear its own costs and expenses for such removal.

7.13 Relevant space and facilities to be ready 6 months prior to the date of issuance of Temporary Occupation Permit

- 7.13.1 Where the developer or owner wishes to have telecommunications services (including public cellular mobile telecommunication services) provided to the development starting from the TOP Date, the developer or owner shall ensure that the relevant space and facilities (e.g. mobile deployment space, main distribution frame room, telecommunications risers and lead-in pipes) are ready for use by the licensees at least 6 months before the TOP Date.

7.14 Obligation to provide, maintain and grant the use of, and access to the relevant space and facilities

- 7.14.1 The developer or owner shall comply with the requirements specified in paragraphs 2.3 to 2.6 of chapter 2, which shall apply mutatis mutandis to the space and facilities required to be provided under this chapter.

CHAPTER 8 DEVELOPMENT CONSISTING OF 1 OR MORE NON-RESIDENTIAL BUILDINGS OF A TOTAL USABLE FLOOR AREA OF MORE THAN 2,000m²

8.1 Application of this chapter

- 8.1.1 This chapter specifies the space and facilities to be provided for a development, consisting of 1 or more non-residential buildings, with a total usable floor area of more than 2,000m². IMDA reserves the right to require any developer or owner to provide additional space and facilities, to meet the demand for telecommunication services where necessary.
- 8.1.2 If a relevant development consists of a total usable floor area of more than 200,000m², the developer or owner shall consult IMDA on the space and facilities to be provided and comply with such requirements as may be imposed by IMDA.
- 8.1.3 Where a development consists of any buildings (or any parts thereof) used for the provision of vital services, the developer or owner shall provide the additional space and facilities required for resiliency and diversity purposes as set out in paragraph 1.4.4 of chapter 1.

8.2 Provision of the main distribution frame room

- 8.2.1 A minimum of 1 main distribution frame room shall be provided in every relevant development.
- 8.2.2 Where –
- (a) there is no basement level or a single basement level, the main distribution frame room shall be located on the first or second storey of the relevant development; and
 - (b) there are multiple basement levels, the main distribution frame room shall be located –
 - (i) on the first or second storey; or
 - (ii) on the uppermost basement level provided that –
 - (A) in the event of flooding in the main distribution frame room leading to an outage in the provision of telecommunication services supplied to the development, the developer or owner shall bear all costs incurred by the relevant licensee in restoring the telecommunication services in the development except that where the relevant licensee is restoring such services to the development and external properties, the developer or owner shall only be obliged to bear a reasonable proportion of such costs attributable to the provision of telecommunication services to the development;
 - (B) in the event of flooding in the main distribution frame leading to damage caused to any installation, plant or system of any licensee by the flooding, the developer or owner shall bear all costs incurred by the relevant licensee in replacing such damaged installation,

plant or system of the licensee except that where such damaged installation, plant or system is also deployed by the licensee to serve external properties, the developer or owner shall only be obliged to bear a reasonable proportion of such costs attributable to the provision of telecommunication services to the development; and

- (C) in the event of flooding in the main distribution frame room leading to an outage in the provision of telecommunication services supplied to the development and/or damage caused to any licensee's installation, plant or system, the developer or owner shall –
- (I) promptly notify the tenants of the development that telecommunication services may be affected as a result of such event; and
- (II) relocate the main distribution frame room to another location in the first or second storey of the development and bear all costs in connection therewith except that where the installation, plant or system is also deployed by the licensee at the main distribution frame room to serve external properties, the developer or owner shall only be obliged to bear a reasonable proportion of such costs attributable to the provision of telecommunication services to the development.

8.2.3 The size of the main distribution frame room to be provided under paragraph 8.2.1 shall be based on the total usable floor area of the non-residential building in the relevant development, as specified in Table 8.2.3.

Table 8.2.3 Total size of main distribution frame room to be provided in each relevant development

Total usable floor area in the development ('000 m ²)	Minimum total floor area of the main distribution frame room (m ²)	Minimum height of the main distribution frame room (m)
> 2 - 5	12	3.5
> 5 - 12	20	
> 12 - 25	30	
> 25 - 50	40	
> 50 - 75	60	
> 75 - 100	80	
> 100 - 125	100	
> 125 - 150	120	
> 150 - 175	140	
> 175 - 200	160	

8.2.4 Where the usable floor area of the relevant development exceeds 50,000m², 2 or more main distribution frame rooms shall be provided to facilitate cable distribution by licensees. The total combined size of the main distribution frame rooms shall be no less than the minimum size specified in Table 8.2.3 based on the relevant usable floor area, and each main distribution frame room shall be at least 12m².

8.2.5 The developer or owner shall, in accordance with the requirements set out in chapter 12, provide for ventilation of the main distribution frame room by way of –

- (a) air-conditioning from the central system (where central air-conditioning system is provided in the relevant development); or
 - (b) louvres and, where necessary, exhaust fans.
- 8.2.6 3 sets of electrical distribution panels operating on 230V, single phase, 50Hz power supply connecting to switch socket outlets and isolators shall be provided in the main distribution frame room in accordance with paragraphs 8.2.7 and 8.2.8.
- 8.2.7 Every electrical distribution panel shall contain –
- (a) a 30mA residual current circuit breaker of appropriate electrical current rating and miniature circuit breakers for final circuit connections, to facilitate the installation of electrical meters;
 - (b) 2 spare 20A miniature circuit breakers; and
 - (c) a single-line diagram in each panel.
- 8.2.8 Switch socket outlets and isolators shall be provided in every main distribution frame room in accordance with the quantities specified in Table 8.2.8 which are to be distributed evenly between the 3 sets of electrical distribution panels.

Table 8.2.8 Number of switch socket outlets and isolators for every main distribution frame room of each relevant development

Size of main distribution frame room (m ²)	Minimum number of switch socket outlets to be provided in the main distribution frame room	Minimum number of isolators to be provided in the main distribution frame room
≤ 30	3 x 2-gang 13A	6 x 30A
> 30	3 x 2-gang 13A	9 x 30A

- 8.2.9 Where a standby power generator is provided in the relevant development, the power supply to the main distribution frame room shall be connected to such standby power generator.
- 8.2.10 Where a standby power generator is not provided in the relevant development, the 30A isolators in the main distribution frame room shall be connected to power sockets for connection to portable power generators and equipped with a manually activated switch to effect the changeover.
- 8.2.11 Natural and/or electrical lighting shall be provided in the main distribution frame room.
- 8.2.12 A clean earth of 1Ω or less (without the use of salt) shall be provided for the exclusive use of licensees' installation or plant in the main distribution frame room. The clean earth shall be connected directly to –
- (a) an independent earth electrode system; and
 - (b) the development's electrical safety earth system.
- 8.2.13 Where the usable floor area of the development served by a main distribution frame room is 25,000m² and below, the clean earth that is provided pursuant to paragraph

8.2.12 shall be in the form of a copper earth bar of at least 300mm in length, 8mm in width and 5mm in thickness, with screw holes that are 6mm in diameter.

8.2.14 Where the usable floor area of the development served by a main distribution frame room is more than 25,000m², the clean earth that is provided pursuant to paragraph 8.2.12 shall be in the form of a copper earth bar of at least 600mm in length, 8mm in width and 5mm in thickness, with screw holes that are 6mm in diameter.

8.2.15 In addition to the requirements set out in paragraphs 8.2.1 to 8.2.14, the main distribution frame room shall be provided in accordance with the requirements set out in chapter 12.

8.3 Provision of lead-in pipes, underground pipes and manholes where there is no basement in the development

8.3.1 Continuous lead-in pipes and underground pipes shall be provided for the relevant development as follows –

(a) the lead-in pipes shall extend from the boundary of the development to the abutting road, to a point 1m beyond the roadside drain located immediately outside the development; and

(b) the underground pipes shall connect from the lead-in pipes at the boundary of the development and run to the main distribution frame room.

8.3.2 The number of lead-in pipes and underground pipes to be provided under paragraph 8.3.1 shall be in accordance with the quantities specified in Table 8.3.2.

Table 8.3.2 Number of lead-in pipes and underground pipes to be provided for relevant development with no basement

Size of the main distribution frame room (m²)	Minimum number of lead-in & underground pipes to be provided
< 30	8
30 - < 40	10
40 - < 60	14
60 - < 80	20
80 - < 100	24
100 - < 120	28
120 - < 140	32
140 - <160	40
≥ 160	48

8.3.3 The underground pipes shall enter the main distribution frame room in accordance with the formation specified in Table 8.3.3.

Table 8.3.3 Pipe formation in the main distribution frame room

Size of the main distribution frame room (m ²)	Pipe formation in the main distribution frame room
< 30	2 x 4
30 - < 40	2 x 5
40 - < 60	2 x 7
60 - < 80	2 sets of 2 x 5
80 - < 100	2 sets of 2 x 6
100 - < 120	2 sets of 2 x 7
120 - < 140	2 sets of 2 x 8
140 - <160	2 sets of 2 x 10
≥ 160	2 sets of 2 x 12

- 8.3.4 Where the size of the main distribution frame room is 60m² or more, the 2 sets of underground pipes to be provided in accordance with paragraph 8.3.3 shall enter the main distribution frame room in different directions.
- 8.3.5 For the purposes of paragraph 8.3.1, all lead-in pipes and underground pipes shall be made of unplasticised polyvinyl chloride (uPVC) material with a nominal diameter of 110mm and be compliant with the Singapore Standard SS:272.
- 8.3.6 In addition to the requirements set out in paragraphs 8.3.1 to 8.3.5, all lead-in pipes and underground pipes shall be provided in accordance with the requirements set out in chapter 11.
- 8.3.7 Manholes shall be provided in each relevant development as follows –
- (a) a manhole shall be constructed at every location where there is effectively an approximately 90° or sharper bend in the direction of the underground pipes; and
 - (b) a minimum of 1 manhole must be provided for every 150m segment of underground pipes laid.
- 8.3.8 The type of manhole to be provided under paragraph 8.3.7 shall be in accordance with Table 8.3.8 based on the highest number of underground pipes entering any one side of the manhole.

Table 8.3.8 Type of manhole to be provided

Highest number of underground pipes entering any one side of the manhole	Type of manhole to be provided
≤ 2	JX2
3 - 6	MX1
7 - 9	MX2
10 - 12	MX3
13 - 16	MX4
17 - 24	MX5

- 8.3.9 Where the developer or owner is required to provide manholes in the development, the manhole covers shall be designed in accordance with the requirements set out in 11.6.
- 8.3.10 In addition to the requirements set out in paragraphs 8.3.7 to 8.3.9, all manholes shall be provided in accordance with the requirements set out in chapter 11.

8.4 Provision of lead-in pipes, underground pipes, manholes and cable trays where there is 1 or more basement level(s) in the development

- 8.4.1 Continuous lead-in pipes and underground pipes shall be provided for the relevant development as follows –
- (a) the lead-in pipes shall extend from the boundary of the development to the abutting road, to a point 1m beyond the roadside drain located immediately outside the development; and
 - (b) the underground pipes shall connect from the lead-in pipes at the boundary of the development and run to the retaining wall of the development.
- 8.4.2 The number of lead-in pipes and underground pipes to be provided under paragraph 8.4.1 shall be in accordance with the quantities specified in Table 8.4.2.

Table 8.4.2 Number of lead-in pipes and underground pipes to be provided for the relevant development with 1 or more basement level(s)

Size of the main distribution frame room (m²)	Minimum number of lead-in & underground pipes to be provided
< 30	8
30 - < 40	10
40 - < 60	14
60 - < 80	20
80 - < 100	24
100 - < 120	28
120 - < 140	32
140 - <160	40
≥ 160	48

- 8.4.3 Where the size of the main distribution frame room is 60m² or more, half of the underground pipes that run to the retaining wall of the development shall enter the basement from a different direction.
- 8.4.4 For the purposes of paragraph 8.4.1, all lead-in pipes and underground pipes shall be made of unplasticised polyvinyl chloride (uPVC) material with a nominal diameter of 110mm and be compliant with the Singapore Standard SS:272.
- 8.4.5 A cable sealing module system shall be installed at the retaining wall of the development to prevent any ingress of water flowing from the underground pipes into the basement.

- 8.4.6 In addition to the requirements set out in paragraphs 8.4.1 to 8.4.5, all lead-in pipes and underground pipes shall be provided in accordance with the requirements set out in chapter 11.
- 8.4.7 Manholes shall be provided in each relevant development as follows –
- (a) a manhole shall be constructed at every location where there is effectively an approximately 90° or sharper bend in the direction of the underground pipes; and
 - (b) a minimum of 1 manhole must be provided for every 150m segment of underground pipes laid.
- 8.4.8 The type of manholes to be provided under paragraph 8.4.7 shall be in accordance with Table 8.4.8 based on the highest number of underground pipes entering any one side of the manhole.

Table 8.4.8 Types of manhole to be provided

Highest number of underground pipes entering any one side of the manhole	Type of manhole to be provided
≤ 2	JX2
3 - 6	MX1
7 - 9	MX2
10 - 12	MX3
13 - 16	MX4
17 - 24	MX5

- 8.4.9 Where the developer or owner is required to provide manholes in the development, the manhole covers shall be designed in accordance with the requirements set out in 11.6.
- 8.4.10 In addition to the requirements set out in paragraphs 8.4.7 to 8.4.9, all manholes shall be provided in accordance with the requirements set out in chapter 11.
- 8.4.11 A minimum of 2 cable trays (for telecommunication) shall be provided from the retaining wall of the development to each main distribution frame room.
- 8.4.12 The total width of these 2 cable trays shall cover the total cross-sectional width of the underground pipes terminating at the retaining wall.
- 8.4.13 Where additional main distribution frame rooms are provided, the developer or owner shall consult IMDA on the quantity and size of cable trays to be provided between each main distribution frame room, and comply with such requirements as may be imposed by IMDA.

8.5 Provision of telecommunication risers

- 8.5.1 Telecommunication risers shall be provided in every non-residential building in the relevant development.

- 8.5.2 The serving radius of each telecommunication riser shall not exceed 40m. Each telecommunication riser shall be labelled as “Telecom Riser” and numbered for easy reference and identification.
- 8.5.3 All telecommunication riser shafts must be constructed in a direct vertical line throughout the building.
- 8.5.4 The dimensions of each telecommunication riser to be provided under paragraph 8.5.1 shall be based on the usable floor area of the non-residential building, as specified in Table 8.5.4.

Table 8.5.4 Dimensions of the telecommunication riser

Total usable floor area of the building (per '000 m ²)	Minimum dimensions of the telecommunication riser
≤ 75	1100 mm (width) x 800 mm (depth)
> 75	1600 mm (width) x 800 mm (depth)

- 8.5.5 Every telecommunication riser shall have a door which can be fully opened outwards throughout its entire width for easy access at each floor level. The height of the door shall be at least 2.1m. The width of the door shall be in accordance with the dimensions specified in Table 8.5.5 below.

Table 8.5.5 Minimum width of door of the telecommunication riser

Minimum dimensions of the telecommunication riser	Minimum width of door of the telecommunication riser
1100mm (width) x 800mm (depth)	900mm
1600mm (width) x 800mm (depth)	Double leaf door of total minimum width of 1400mm

- 8.5.6 All doors of the telecommunication risers shall be locked.
- 8.5.7 A minimum of 2 cable trays (for telecommunication) shall be provided in each telecommunication riser from the first storey or basement to the topmost level of every non-residential building.
- 8.5.8 The 2 cable trays (for telecommunication) shall be installed opposite each other on the side walls of the telecommunication riser.
- 8.5.9 For the purposes of paragraph 8.5.7, cable trays shall be provided in accordance with the requirements specified in Table 8.5.9.

Table 8.5.9 Width of cable trays in each telecommunication riser

	Minimum width of each cable tray where the building has up to and including 25 storeys	Minimum width of cable trays where the building has more than 25 storeys
Cable trays (for telecommunication)	450 mm	600 mm

8.5.10 The telecommunication riser openings on every storey in each non-residential building shall be sealed in accordance with the Code of Practice for Fire Precautions in Buildings issued by Singapore Civil Defence Force.

8.5.11 In addition to the requirements set out in paragraphs 8.5.1 to 8.5.10, all telecommunication risers shall be provided in accordance with the requirements set out in chapter 13.

8.6 Provision of cable trays from the main distribution frame room to each telecommunication riser

8.6.1 A minimum of 2 cable trays (for telecommunication) with a width of 600mm each shall be provided from the main distribution frame room to each telecommunication riser.

8.6.2 Slots of a minimum height of 300mm shall be provided in the wall of each telecommunication riser for cable trays to pass through.

8.7 Provision of a cable distribution system and 2-way air-blown fibre microducts from the telecommunication riser to each non-residential unit

8.7.1 A cable distribution system shall be provided to facilitate the laying of telecommunication cables from the telecommunication riser to each non-residential unit. The developer or owner may select an appropriate cable distribution system as described in the Guidelines for Info-communication Facilities in Buildings for the development.

8.7.2 The developer or owner of a development shall –

- (a) provide 2-way air-blown fibre microducts (5/3.5)mm from the telecommunication riser to each non-residential unit in the building;
- (b) provide 2-way air-blown fibre microducts (5/3.5)mm from the telecommunication riser to other locations which require fibre services, e.g. Fire Command Centre, Reception/Information Counter;
- (c) the 2-way air-blown fibre microducts (5/3.5)mm shall be terminated in the telecommunication riser and terminated into a tube patch panel with bulkhead connectors. The tube patch panel shall be located at a height of 1.5m (from floor finish) and placed on the width of the telecommunication riser. The tube patch panel shall come with a supporting bracket to allow a turning radius of 100mm or 20 times the diameter of the 2-way air-blown fibre microducts. The number of ports of the tube patch panel shall be determined by the number of non-residential units on that level served by the telecommunication riser or a minimum of 8 ports of tube patch panel whichever is more.
- (d) the 2-way air-blown fibre microducts (5/3.5)mm terminated in the non-residential unit, shall be located next to the electrical distribution panel, and with a 1m coil. Where there is no electrical distribution panel in the non-residential unit, the 2-way air-blown fibre microducts (5/3.5)mm shall be located at a height of 2m (from floor finish) with a 1m coil upon entering the non-residential unit;
- (e) end caps shall be provided at the ends of the 2-way air-blown fibre microducts located in the non-residential unit; and

- (f) the 2-way air-blown fibre microducts (5/3.5)mm, tube patch panel and end caps shall be provided in accordance with the requirements set out in chapter 15.

8.8 Provision of mobile deployment space

- 8.8.1 The developer or owner shall provide mobile deployment space in accordance with all the requirements specified in this paragraph 8.8 at its own cost and expense, unless otherwise stated.
- 8.8.2 As a general principle, the mobile deployment space provided by a developer or owner of shall be prioritised to serve the mobile coverage needs of the relevant development. Nevertheless, to enable mobile telecommunication licensees to optimise the use of mobile deployment space to provide mobile coverage to multiple buildings using the same set of installation, plant and systems, mobile telecommunication licensees may, in addition to serving the relevant development, use the mobile deployment space to provide mobile coverage to any land or building located outside of the relevant development. For the avoidance of doubt, no developer or owner shall refuse to provide mobile deployment space on the ground that it will be used by a mobile telecommunication licensee to provide mobile coverage to any external properties in addition to the relevant development.
- 8.8.3 If the relevant development consists of 1 or more non-residential buildings with a total mobile coverage area of more than 2,000m², the developer or owner shall, where required and notified by any mobile telecommunication licensee, provide within a reasonable time, mobile deployment space in accordance with the dimensions as specified in Table 8.8.3 based on the mobile coverage area in the development. If the relevant development consists of a total mobile coverage area of more than 200,000m², the developer or owner shall consult IMDA on the mobile deployment space to be provided and comply with such requirements as may be imposed by IMDA.

Table 8.8.3 Mobile deployment space to be provided in each relevant development

Total mobile coverage area ('000 m ²)	Mobile deployment space (m ²)	Minimum height of mobile deployment space (m)
> 2 - ≤ 6	24	3
> 6 - ≤ 20	36	
> 20 - ≤ 100	54	
> 100 - ≤ 200	72	
> 200	To consult IMDA	

- 8.8.4 The amount of mobile deployment space provided by a developer or owner shall be computed based on the footprint (i.e. floor space) occupied by the installation, plant or systems (e.g. antennas, base stations, remote radio units, combiners and power distribution boxes) deployed by a mobile telecommunication licensee at the mobile deployment space.
- 8.8.5 For the avoidance of doubt, the space occupied by facilities required to be installed to serve the installation, plant and systems deployed by a mobile telecommunication licensee at the mobile deployment space (e.g. cable distribution systems and power

distribution systems) shall not be counted towards the computation of the mobile deployment space.

- 8.8.6 Where a mobile telecommunication licensee requires any additional space, the mobile telecommunication licensee shall consult with and obtain the approval of the developer or owner for the provision of such additional space, on such prices, terms and conditions as may be agreed between the parties.
- 8.8.7 The developer or owner shall, where required and notified by any mobile telecommunication licensee, within a reasonable time, grant the mobile telecommunication licensee access to all common areas within the relevant development which may reasonably serve as mobile deployment space (including but not limited to building rooftops) to enable the mobile telecommunication licensee to carry out feasibility studies and site surveys to identify suitable mobile deployment spaces.
- 8.8.8 The location of the mobile deployment space to be provided under paragraph 8.8.3 shall be determined by the mobile telecommunication licensee in consultation with the developer or owner, subject to the following –
- (a) where feasible, the mobile deployment space shall be located on the rooftops of buildings to optimise the coverage of the installation, plant or systems to be deployed by the mobile telecommunication licensee;
 - (b) there shall be adequate access and work space provided around equipment sited in the mobile deployment space to reasonably enable the mobile telecommunication licensee to carry out any requisite works in relation to the installation, plant or systems deployed therein;
 - (c) the mobile telecommunication licensee shall, where practicable, take suitable measures to address any reasonable concerns that the developer or owner may have in relation to the aesthetics of the mobile deployment space;
 - (d) the mobile deployment space may be split into one (1) or more locations within the relevant development so as to facilitate the provision of public cellular mobile telecommunication services to the whole development, provided that the total amount of mobile deployment space at all locations combined shall not exceed the maximum amounts specified in paragraph 8.8.3;
 - (e) the mobile deployment space shall be located at any unused space in the development;
 - (f) the mobile deployment space shall not be located in the main distribution frame room or the telecommunication equipment room, unless there is sufficient space available after having fulfilled the space requirements of the main distribution frame room or telecommunication equipment room and there is a clear demarcation of the space designated as mobile deployment space; and
 - (g) the mobile deployment space shall not be located in any area that –
 - (i) is susceptible to the risk of flooding;
 - (ii) is directly subject to the discharge of water, steam, fumes, gases or dust;
 - (iii) is within or near a bin centre; and

- (iv) is not able to withstand a loading of 1.5kN/m² or more; and
- (v) will subject the installation, plant or systems deployed therein to vibration of more than 0.05 G, where G is the acceleration due to gravity (G=9.81 m/s²).

8.8.9 Where a developer or owner objects to the location of any mobile deployment space selected by the mobile telecommunication licensee, both parties shall co-operate in good faith to resolve the matter in a timely manner, having regard to parameters stated in paragraph 8.8.8. In the event that parties are unable to reach agreement, they may refer the matter to IMDA for a decision which shall be binding on the parties.

8.8.10 Where –

- (a) the developer or owner is responsible for complying with any statutory or regulatory requirements or obtaining any requisite approvals for its provision of the mobile deployment space, the developer or owner shall do so in a timely manner; and
- (b) the mobile telecommunication licensee is responsible for complying with any statutory or regulatory requirements or obtaining any requisite approvals for its use of the mobile deployment space, the developer or owner shall render all necessary assistance as the mobile telecommunication licensee may reasonably require in a timely manner to enable the mobile telecommunication licensee to do so (e.g. providing the developer's or owner's endorsement, where required, on applications submitted by the mobile telecommunication licensee to relevant authorities in connection with the mobile deployment space), save that the mobile telecommunication licensee shall bear the cost and expense for carrying out any actions within its responsibility. Where the mobile telecommunication licensee is responsible for complying with any statutory or regulatory requirements or obtaining any requisite approvals for its use of the mobile deployment space, the licensee shall do so at its own cost and expense.

8.8.11 Where the mobile telecommunication licensee requires lighting and ventilation to be provided at a mobile deployment space to enable the mobile telecommunication licensee to deploy and operate its installation, plant or system at that location, the developer or owner shall render all necessary access and assistance in a timely manner to facilitate the provision of such lighting and ventilation, save that the mobile telecommunication licensee shall bear the cost and expense for the provision of the necessary lighting and ventilation.

8.8.12 Where the mobile telecommunication licensee requires –

- (a) facilities (e.g. cable distribution system and power distribution system) to be installed to serve its installation, plant or system deployed at the mobile deployment space; or
- (b) works to be carried out in connection with the installation of such facilities and use of the mobile deployment space (e.g. drilling and coring works, and the opening and reinstatement of false ceilings and access panels),

the developer or owner shall provide all necessary access and assistance in a timely manner to facilitate such installation or works by the mobile telecommunication licensee, save that the mobile telecommunication licensee shall bear the cost and

expense for the installation of the necessary facilities and the carrying out of the necessary works.

8.8.13 Without prejudice to paragraph 8.8.12, the developer or owner shall ensure that the electrical consumer switch room has sufficient power capacity (up to 32A, 3 phase 50Hz power supply per mobile telecommunication licensee) to supply electricity for the operation of the installation, plant or system deployed by the mobile telecommunication licensee at the mobile deployment space.

8.8.14 Where the developer or owner reasonably desires to use the mobile deployment space for other purposes such that it is necessary for the mobile telecommunication licensee to relocate its installation, plant or system deployed at the mobile deployment space to another location within the relevant development, the developer or owner shall –

- (a) ensure that the alternative location within the relevant development is reasonably fit for the purposes of serving as a mobile deployment space; and
- (b) bear all costs and expenses reasonably incurred by the mobile telecommunication licensee in connection with the relocation of its installation, plant or system,

save that where the developer or owner requires the mobile telecommunication licensee to remove its installation, plant or system due to the need to demolish the building, the mobile telecommunication licensee shall bear its own costs and expenses for such removal.

8.9 Relevant space and facilities to be ready 6 months prior to the date of issuance of Temporary Occupation Permit

8.9.1 Where the developer or owner wishes to have telecommunications services (including public cellular mobile telecommunication services) provided to the development starting from the TOP Date, the developer or owner shall ensure that the relevant space and facilities (e.g. mobile deployment space, main distribution frame room, telecommunications risers and lead-in pipes) are ready for use by the licensees at least 6 months before the TOP Date.

8.10 Obligation to seal underground pipes

8.10.1 Where a developer or owner has provided for ventilation of the main distribution frame room by way of air-conditioning, the developer or owner shall ensure that it seals all unused underground pipes at its point of entry into the main distribution frame room with the Appropriate Sealing Material (as defined in paragraph 8.10.2) prior to the TOP Date.

8.10.2 “Appropriate Sealing Material” means a material that is able to prevent foreign gaseous matter (which may be toxic or flammable) from passing through the underground pipes into the main distribution frame room and which shall be durable, easily removable to facilitate installation of cables, and not cause damage to the underground pipes or any telecommunication cables that may be installed therein.

8.11 Obligation to provide, maintain and grant the use of, and access to the relevant space and facilities

- 8.11.1 The developer or owner shall comply with the requirements specified in paragraphs 2.3 to 2.6 of chapter 2, which shall apply mutatis mutandis to the space and facilities required to be provided under this chapter.

CHAPTER 9 DEVELOPMENT CONSISTING OF 1 OR MORE NON-RESIDENTIAL BUILDINGS OF A TOTAL USABLE FLOOR AREA OF UP TO AND INCLUDING 2,000m²

9.1 Application of this chapter

9.1.1 This chapter specifies the space and facilities to be provided for a development, consisting of 1 or more non-residential buildings, of a total usable floor area of up to and including 2,000m². IMDA reserves the right to require any developer or owner to provide additional space and facilities, to meet the demand for telecommunication services where necessary.

9.1.2 Where a development consists of any buildings (or any parts thereof) used for the provision of vital services, the developer or owner shall provide the additional space and facilities required for resiliency and diversity purposes as set out in paragraph 1.4.4 of chapter 1.

9.2 Provision of the main distribution frame room

9.2.1 A main distribution frame room shall be provided in every relevant development.

9.2.2 Where –

(a) there is no basement level or a single basement level, the main distribution frame room shall be located on the first or second storey of the relevant development; and

(b) there are multiple basement levels, the main distribution frame room shall be located –

(i) on the first or second storey; or

(ii) on the uppermost basement level provided that –

(A) in the event of flooding in the main distribution frame room leading to an outage in the provision of telecommunication services supplied to the development, the developer or owner shall bear all costs incurred by the relevant licensee in restoring the telecommunication services in the development except that where the relevant licensee is restoring such services to the development and external properties, the developer or owner shall only be obliged to bear a reasonable proportion of such costs attributable to the provision of telecommunication services to the development;

(B) in the event of flooding in the main distribution frame leading to damage caused to any installation, plant or system of any licensee by the flooding, the developer or owner shall bear all costs incurred by the relevant licensee in replacing such damaged installation, plant or system of the licensee except that where such damaged installation, plant or system is also deployed by the licensee to serve external properties, the developer or owner shall only be obliged to

bear a reasonable proportion of such costs attributable to the provision of telecommunication services to the development; and

- (C) in the event of flooding in the main distribution frame room leading to an outage in the provision of telecommunication services supplied to the development and/or damage caused to any licensee's installation, plant or system, the developer or owner shall –
 - (I) promptly notify the tenants of the development that telecommunication services may be affected as a result of such event; and
 - (II) relocate the main distribution frame room to another location in the first or second storey of the development and bear all costs in connection therewith except that where the installation, plant or system is also deployed by the licensee at the main distribution frame room to serve external properties, the developer or owner shall only be obliged to bear a reasonable proportion of such costs attributable to the provision of telecommunication services to the development.

9.2.3 The minimum dimensions of the main distribution frame room shall be 3m (length) by 2m (breadth) by 3.5m (height).

9.2.4 The developer or owner shall, in accordance with the requirements set out in chapter 12, provide for ventilation of the main distribution frame room by way of:

- (a) air-conditioning from the central system (where central air-conditioning system is provided in the relevant development); or
- (b) louvres and, where necessary, exhaust fans.

9.2.5 3 sets of electrical distribution panels operating on 230V, single phase, 50Hz power supply connecting to three (3) 2-gang 13A switch socket outlets and two (2) 20A isolators shall be provided in the main distribution frame room.

9.2.6 Every electrical distribution panel shall contain –

- (a) a 30mA residual current circuit breaker of appropriate electrical current rating and miniature circuit breakers for final circuit connections, to facilitate the installation of electrical meters;
- (b) 2 spare 20A miniature circuit breakers; and
- (c) a single-line diagram in each panel.

9.2.7 Where a standby power generator is provided in the relevant development, the power supply to the main distribution frame room shall be connected to such standby power generator.

9.2.8 Natural and/or electrical lighting shall be provided in the main distribution frame room.

9.2.9 Switch socket outlets and isolators shall be provided in the main distribution frame room which are to be distributed evenly among the 3 sets of electrical distribution panels.

- 9.2.10 A clean earth of 1Ω or less (without the use of salt) shall be provided for the exclusive use of telecommunication installation or plant in the main distribution frame room. The clean earth shall be connected directly to –
- (a) an independent earth electrode system; and
 - (b) the development's electrical safety earth system.
- 9.2.11 The clean earth that is provided pursuant to paragraph 9.2.10 shall be in the form of a copper earth bar of at least 300mm in length, 8mm in width and 5mm in thickness, with screw holes that are 6mm in diameter.
- 9.2.12 In addition to the requirements set out in paragraphs 9.2.1 to 9.2.11, the main distribution frame room shall be provided in accordance with the requirements set out in chapter 12.

9.3 Provision of lead-in pipes, underground pipes and manholes

- 9.3.1 A minimum of 6 continuous lead-in pipes and underground pipes shall be provided for the relevant development as follows –
- (a) the lead-in pipes shall extend from the boundary of the development to the abutting road, to a point 1m beyond the roadside drain located immediately outside the development; and
 - (b) the underground pipes shall connect from the lead-in pipes at the boundary of the development and run to the main distribution frame room.
- 9.3.2 For the purpose of paragraph 9.3.1 all lead-in pipes and underground pipes shall be made of unplasticised polyvinyl chloride (uPVC) material with a nominal diameter of 110mm and be compliant with the Singapore Standard SS:272.
- 9.3.3 In addition to the requirements set out in paragraphs 9.3.1 to 9.3.2, all lead-in pipes and underground pipes shall be provided in accordance with the requirements set out in chapter 11.
- 9.3.4 Manholes shall be provided in each relevant development as follows –
- (a) a manhole shall be constructed at every location where there is effectively an approximately 90° or sharper bend in the direction of the underground pipes; and
 - (b) a minimum of 1 manhole must be provided for every 150m segment of underground pipes laid.
- 9.3.5 The manholes to be provided under paragraph 9.3.4 shall be of type MX1.
- 9.3.6 Where the developer or owner is required to provide manholes in the development, the manhole covers shall be designed in accordance with the requirements set out in 11.6.

- 9.3.7 In addition to the requirements set out in paragraphs 9.3.4 to 9.3.6, all manholes shall be provided in accordance with the requirements set out in chapter 11.

9.4 Provision of telecommunication risers

- 9.4.1 Telecommunication risers shall be provided in every non-residential multi-storey building in the relevant development.
- 9.4.2 The serving radius of each telecommunication riser shall not exceed 40m. Each telecommunication riser shall be labelled as “Telecom Riser” and numbered for easy reference and identification.
- 9.4.3 All telecommunication riser shafts shall be constructed in a direct vertical line throughout the building.
- 9.4.4 The internal dimensions of a telecommunication riser shall be at least 600mm (width) x 450mm (depth).
- 9.4.5 Every telecommunication riser shall have a door which can be fully opened outwards throughout its entire width for easy access at each floor level. The height of the door shall be at least 2.1m and the width of the door shall be at least 500mm.
- 9.4.6 All doors of the telecommunication risers shall be locked.
- 9.4.7 A minimum of 2 cable trays (for telecommunication), with a minimum width of 300mm each, shall be provided in each telecommunication riser from the first storey or basement to the topmost level of every non-residential building.
- 9.4.8 The 2 cable trays (for telecommunication) shall be installed opposite each other on the side walls of the telecommunication riser.
- 9.4.9 The telecommunication riser openings on every storey in each non-residential building shall be sealed in accordance with the Code of Practice for Fire Precautions in Buildings issued by Singapore Civil Defence Force.
- 9.4.10 In addition to the requirements set out in paragraphs 9.4.1 to 9.4.9, all telecommunication risers shall be provided in accordance with the requirements set out in chapter 13.

9.5 Provision of horizontal cable trays from the main distribution frame room to each telecommunication riser

- 9.5.1 A minimum of 2 cable trays (for telecommunication), with a minimum width of 300mm each, shall be provided from the main distribution frame room to each telecommunication riser.
- 9.5.2 Slots of a minimum height of 300mm shall be provided in the wall of each telecommunication riser for cable trays to pass through.

9.6 Provision of a cable distribution system and 2-way air-blown fibre microducts from the telecommunication riser to each non-residential unit

9.6.1 A cable distribution system shall be provided to facilitate the laying of telecommunication cables from the telecommunication riser to each non-residential unit. The developer or owner may select an appropriate cable distribution system as described in the Guidelines For Info-communication Facilities in Buildings.

9.6.2 The developer or owner of a development shall, in relation to the space and facilities provided pursuant to this Code, at its own expense –

- (a) provide 2-way air-blown fibre microducts (5/3.5)mm from the telecommunication riser to each non-residential unit in the building;
- (b) provide 2-way air-blown fibre microducts (5/3.5)mm from the telecommunication riser to other locations which require fibre services, e.g. Fire Command Centre, Reception/Information Counter;
- (c) the 2-way air-blown fibre microducts (5/3.5)mm shall be terminated in the telecommunication riser and terminated into a tube patch panel with bulkhead connectors. The tube patch panel shall be located at a height of 1.5m (from floor finish) and placed on the width of the telecommunication riser. The tube patch panel shall come with a supporting bracket to allow a turning radius of 100mm or 20 times the diameter of the 2-way air-blown fibre microducts. The number of ports of the tube patch panel shall be determined by the number of non-residential units on that level served by the telecommunication riser or a minimum of 8 ports of tube patch panel whichever is more;
- (d) the 2-way air-blown fibre microducts (5/3.5)mm terminated in the non-residential unit, shall be located next to the electrical distribution panel, and with a 1m coil. Where there is no electrical distribution panel in the non-residential unit, the 2-way air-blown fibre microducts (5/3.5)mm shall be located at a height of 2m (from floor finish) with a 1m coil upon entering the non-residential unit;
- (e) end caps shall be provided at the ends of the 2-way air-blown fibre microducts located in the non-residential unit; and
- (f) the 2-way air-blown fibre microducts (5/3.5)mm, tube patch panel and end caps shall be provided in accordance with the requirements set out in chapter 15.

9.7 Provision of mobile deployment space

9.7.1 The developer or owner shall provide mobile deployment space in accordance with all the requirements specified in this paragraph 9.7 at its own cost and expense, unless otherwise stated.

9.7.2 As a general principle, the mobile deployment space provided by a developer or owner of shall be prioritised to serve the mobile coverage needs of the relevant development. Nevertheless, to enable mobile telecommunication licensees to optimise the use of mobile deployment space to provide mobile coverage to multiple buildings using the same set of installation, plant and systems, mobile telecommunication licensees may, in addition to serving the relevant development, use the mobile deployment space to provide mobile coverage to any land or building located outside of the relevant development. For the avoidance of doubt, no developer

or owner shall refuse to provide mobile deployment space on the ground that it will be used by a mobile telecommunication licensee to provide mobile coverage to any external properties in addition to the relevant development.

- 9.7.3 If the relevant development consists of 1 or more non-residential buildings with a total mobile coverage area of more than 2,000m², the developer or owner shall, where required and notified by any mobile telecommunication licensee, provide within a reasonable time, mobile deployment space in accordance with the dimensions as specified in Table 9.7.3 based on the mobile coverage area in the development. If the relevant development consists of a total mobile coverage area of more than 200,000m², the developer or owner shall consult IMDA on the mobile deployment space to be provided and comply with such requirements as may be imposed by IMDA.

Table 9.7.3 Mobile deployment space to be provided in each relevant development

Total mobile coverage area ('000 m ²)	Mobile deployment space (m ²)	Minimum height of mobile deployment space (m)
> 2 - ≤ 6	24	3
> 6 - ≤ 20	36	
> 20 - ≤ 100	54	
> 100 - ≤ 200	72	
> 200	To consult IMDA	

- 9.7.4 The amount of mobile deployment space provided by a developer or owner shall be computed based on the footprint (i.e. floor space) occupied by the installation, plant or systems (e.g. antennas, base stations, remote radio units, combiners and power distribution boxes) deployed by a mobile telecommunication licensee at the mobile deployment space.
- 9.7.5 For the avoidance of doubt, the space occupied by facilities required to be installed to serve the installation, plant and systems deployed by a mobile telecommunication licensee at the mobile deployment space (e.g. cable distribution systems and power distribution systems) shall not be counted towards the computation of the mobile deployment space.
- 9.7.6 Where a mobile telecommunication licensee requires any additional space, the mobile telecommunication licensee shall consult with and obtain the approval of the developer or owner for the provision of such additional space, on such prices, terms and conditions as may be agreed between the parties.
- 9.7.7 The developer or owner shall, where required and notified by any mobile telecommunication licensee, within a reasonable time, grant the mobile telecommunication licensee access to all common areas within the relevant development which may reasonably serve as mobile deployment space (including but not limited to building rooftops) to enable the mobile telecommunication licensee to carry out feasibility studies and site surveys to identify suitable mobile deployment spaces.
- 9.7.8 The location of the mobile deployment space to be provided under paragraph 9.7.3 shall be determined by the mobile telecommunication licensee in consultation with the developer or owner, subject to the following –

- (a) where feasible, the mobile deployment space shall be located on the rooftops of buildings to optimise the coverage of the installation, plant or systems to be deployed by the mobile telecommunication licensee;
- (b) there shall be adequate access and work space provided around equipment sited in the mobile deployment space to reasonably enable the mobile telecommunication licensee to carry out any requisite works in relation to the installation, plant or systems deployed therein;
- (c) the mobile telecommunication licensee shall, where practicable, take suitable measures to address any reasonable concerns that the developer or owner may have in relation to the aesthetics of the mobile deployment space;
- (d) the mobile deployment space may be split into one (1) or more locations within the relevant development so as to facilitate the provision of public cellular mobile telecommunication services to the whole development, provided that the total amount of mobile deployment space at all locations combined shall not exceed the maximum amounts specified in paragraph 9.7.3;
- (e) the mobile deployment space shall be located at any unused space in the development;
- (f) the mobile deployment space shall not be located in the main distribution frame room or the telecommunication equipment room, unless there is sufficient space available after having fulfilled the space requirements of the main distribution frame room or telecommunication equipment room and there is a clear demarcation of the space designated as mobile deployment space; and
- (g) the mobile deployment space shall not be located in any area that –
 - (i) is susceptible to the risk of flooding;
 - (ii) is directly subject to the discharge of water, steam, fumes, gases or dust;
 - (iii) is within or near a bin centre; and
 - (iv) is not able to withstand a loading of 1.5kN/m² or more; and
 - (v) will subject the installation, plant or systems deployed therein to vibration of more than 0.05 G, where G is the acceleration due to gravity (G=9.81 m/s²).

9.7.9 Where a developer or owner objects to the location of any mobile deployment space selected by the mobile telecommunication licensee, both parties shall co-operate in good faith to resolve the matter in a timely manner, having regard to parameters stated in paragraph 9.7.8. In the event that parties are unable to reach agreement, they may refer the matter to IMDA for a decision which shall be binding on the parties.

9.7.10 Where –

- (a) the developer or owner is responsible for complying with any statutory or regulatory requirements or obtaining any requisite approvals for its provision of the mobile deployment space, the developer or owner shall do so in a timely manner; and

- (b) the mobile telecommunication licensee is responsible for complying with any statutory or regulatory requirements or obtaining any requisite approvals for its use of the mobile deployment space, the developer or owner shall render all necessary assistance as the mobile telecommunication licensee may reasonably require in a timely manner to enable the mobile telecommunication licensee to do so (e.g. providing the developer's or owner's endorsement, where required, on applications submitted by the mobile telecommunication licensee to relevant authorities in connection with the mobile deployment space), save that the mobile telecommunication licensee shall bear the cost and expense for carrying out any actions within its responsibility. Where the mobile telecommunication licensee is responsible for complying with any statutory or regulatory requirements or obtaining any requisite approvals for its use of the mobile deployment space, the licensee shall do so at its own cost and expense.

9.7.11 Where the mobile telecommunication licensee requires lighting and ventilation to be provided at a mobile deployment space to enable the mobile telecommunication licensee to deploy and operate its installation, plant or system at that location, the developer or owner shall render all necessary access and assistance in a timely manner to facilitate the provision of such lighting and ventilation, save that the mobile telecommunication licensee shall bear the cost and expense for the provision of the necessary lighting and ventilation.

9.7.12 Where the mobile telecommunication licensee requires –

- (a) facilities (e.g. cable distribution system and power distribution system) to be installed to serve its installation, plant or system deployed at the mobile deployment space; or
- (b) works to be carried out in connection with the installation of such facilities and use of the mobile deployment space (e.g. drilling and coring works, and the opening and reinstatement of false ceilings and access panels),

the developer or owner shall provide all necessary access and assistance in a timely manner to facilitate such installation or works by the mobile telecommunication licensee, save that the mobile telecommunication licensee shall bear the cost and expense for the installation of the necessary facilities and the carrying out of the necessary works.

9.7.13 Without prejudice to paragraph 9.7.12, the developer or owner shall ensure that the electrical consumer switch room has sufficient power capacity (up to 32A, 3 phase 50Hz power supply per mobile telecommunication licensee) to supply electricity for the operation of the installation, plant or system deployed by the mobile telecommunication licensee at the mobile deployment space.

9.7.14 Where the developer or owner reasonably desires to use the mobile deployment space for other purposes such that it is necessary for the mobile telecommunication licensee to relocate its installation, plant or system deployed at the mobile deployment space to another location within the relevant development, the developer or owner shall –

- (a) ensure that the alternative location within the relevant development is reasonably fit for the purposes of serving as a mobile deployment space; and

- (b) bear all costs and expenses reasonably incurred by the mobile telecommunication licensee in connection with the relocation of its installation, plant or system,

save that where the developer or owner requires the mobile telecommunication licensee to remove its installation, plant or system due to the need to demolish the building, the mobile telecommunication licensee shall bear its own costs and expenses for such removal.

9.8 Relevant space and facilities to be ready 6 months prior to the date of issuance of Temporary Occupation Permit

- 9.8.1 Where the developer or owner wishes to have telecommunication services (including public cellular mobile telecommunication services) provided to the development commencing from the TOP Date, the developer or owner shall ensure that the relevant space and facilities (e.g. mobile deployment space, main distribution frame room, telecommunication risers and lead-in pipes) are ready for use by the licensees at least 6 months before the TOP Date.

9.9 Obligation to seal underground pipes

- 9.9.1 Where a developer or owner has provided for ventilation of the main distribution frame room by way of air-conditioning, the developer or owner shall ensure that it seals all unused underground pipes at its point of entry into the main distribution frame room with the Appropriate Sealing Material (as defined in paragraph 9.9.2) prior to the TOP Date.
- 9.9.2 "Appropriate Sealing Material" means a material that is able to prevent foreign gaseous matter (which may be toxic or flammable) from passing through the underground pipes into the main distribution frame room and which shall be durable, easily removable to facilitate installation of cables, and not cause damage to the underground pipes or any telecommunication cables that may be installed therein.

9.10 Obligation to provide, maintain and grant the use of, and access to the relevant space and facilities

- 9.10.1 The developer or owner shall comply with the requirements specified in paragraphs 2.3 to 2.6 of chapter 2, which shall apply mutatis mutandis to the space and facilities required to be provided under this chapter.

CHAPTER 10 DEVELOPMENT CONSISTING OF 1 OR MORE TUNNELS

10.1 Application of this chapter

- 10.1.1 This chapter specifies the space and facilities to be provided for a development which consists of 1 or more road or train tunnels. IMDA reserves the right to require any developer or owner to provide additional space and facilities, to meet the demand for telecommunication services where necessary.
- 10.1.2 Where a development consists of 1 or more non-residential buildings in addition to 1 or more road or train tunnels, the developer or owner shall also refer to chapter 8 or 9 (as the case may be) for the relevant space and facilities requirements for the non-residential building(s) within the development.

10.2 Provision of mobile deployment space for road tunnel coverage

- 10.2.1 Subject to paragraph 10.2.2, the developer or owner shall provide mobile deployment space in each relevant development which consists of 1 or more road tunnels as follows –
- (a) for every facility building (or its equivalent) that is associated with road tunnels, the developer or owner shall provide a mobile deployment space of 60m² in each such facility building (or its equivalent) or within the vicinity of such road tunnels; or
 - (b) where any road tunnel is not associated with any facility building, the developer or owner shall provide a mobile deployment space of 60m² within the vicinity of such road tunnels.
- 10.2.2 Where the relevant development consists of 1 or more road tunnels each of which is 1 km or shorter, the developer or owner shall consult IMDA on the mobile deployment space to be provided for each such tunnel and comply with such requirements as may be imposed by IMDA.
- 10.2.3 Where the mobile deployment space is located in a road tunnel ventilation building, the minimum floor loading requirement shall be 7.5Kn/m².

10.3 Provision of mobile deployment space for train tunnel coverage

- 10.3.1 For every train line, the developer or owner shall provide a mobile deployment space of 60m² in each underground train station associated with that train line. For the avoidance of doubt, where the underground train station is associated with more than 1 train line, the developer or owner shall provide a separate mobile deployment space of 60m² for each train line associated with it.
- 10.3.2 Where the mobile deployment space is located in an underground train station, the minimum floor loading requirement shall be 7.5Kn/m².

10.4 Additional provision for road tunnel

- 10.4.1 For every road tunnel, unless otherwise agreed with the mobile telecommunication licensee, the developer or owner shall provide, at every interval of 200 metres, a niche of 7m (length) x 1.5m (height) x 0.7m (depth).
- 10.4.2 For every road tunnel, the developer or owner shall provide a 20A isolator at every niche as specified in paragraph 10.4.1. For every mobile deployment space provided for road tunnel coverage as specified in paragraph 10.2, the developer or owner shall provide 4 x 32A power source, or meet such power requirements as may be agreed with the mobile telecommunication licensee.
- 10.4.3 For every road tunnel, the developer or owner shall provide adequate space for the deployment of the mobile telecommunication licensee's leaky coaxial cable. This space, accommodating at least 2, and up to 4, leaky coaxial cables, with spacing of 0.3m between them, shall be located along the centre of the ceiling of the road tunnels.

10.5 Additional provision for train tunnel

- 10.5.1 For every train line, unless otherwise agreed with the mobile telecommunication licensee, the developer or owner shall provide, at every interval of 200 metres, a wall space of 10m (length) x 0.5m (height) x 0.7m (depth). The mobile telecommunication licensee, in consultation with the developer or owner, will specify the interval of the additional wall space.
- 10.5.2 For every train line, the developer or owner shall provide a 20A isolator at every wall space, as specified in paragraph 10.5.1. For every mobile deployment space provided for train tunnel coverage as specified in paragraph 10.3, the developer or owner shall provide 5 x 32A power source, or meet such power requirements as may be agreed with the mobile telecommunication licensee.
- 10.5.3 For every train line, the developer or owner shall provide adequate space for the deployment of mobile telecommunication licensee's leaky coaxial cable. This space, accommodating at least 2, and up to 4, leaky coaxial cables, with spacing of 0.3m between them, shall be located at the window height of the trains.

10.6 Obligation to provide, maintain and grant the use of, and access to the relevant space and facilities

- 10.6.1 The developer or owner shall comply with the requirements specified in paragraphs 2.3 to 2.6 of chapter 2, which shall apply mutatis mutandis to the space and facilities required to be provided under this chapter.

CHAPTER 11 SPECIFIC REQUIREMENTS FOR LEAD-IN PIPES, UNDERGROUND PIPES AND MANHOLES

11.1 Overview

11.1.1 This chapter sets out the specific requirements to be complied with by every developer or owner who is required to provide –

- (a) lead-in pipes;
- (b) underground pipes; and/or
- (c) manholes (including manhole covers),

under this Code.

11.1.2 The quantities of lead-in pipes, underground pipes and manholes specified in this Code are the minimum quantities required to be provided. IMDA reserves the right to require any developer or owner to provide additional lead-in pipes, underground pipes and manholes to meet the demand for telecommunication services where necessary.

11.2 Qualified builders

11.2.1 Every developer or owner who is required to provide lead-in pipes, underground pipes and manholes shall ensure that they are constructed by builders who are registered with the Building and Construction Authority under the CR07 (Construction Related Workhead) category specialising in “Cable/Pipe Laying and Road Reinstatement”. The list of registered contractors may be obtained from the Building and Construction Authority website (<http://www.bca.gov.sg>).

11.3 General requirements for all pipes

11.3.1 Every developer or owner who is required to provide lead-in pipes or underground pipes or both shall for such purpose –

- (a) use only pipes and associated couplings that are made from unplasticised polyvinyl chloride (uPVC) material which are compliant with the Singapore Standard SS:141 Class C, Singapore Standard SS:272 or its equivalent;
- (b) use only pipes and associated couplings that are no darker than the grey colour;
- (c) provide all pipes in lengths of 6.0m as specified in the Singapore Standard SS:141 Class C, Singapore Standard SS:272 or its equivalent;
- (d) provide all pipes complete with 1 coupling per pipe;
- (e) ensure that all pipes are clearly, indelibly and continuously marked at intervals of not more than 1.0m along the length of the pipe using a distinctive colour with the following description –

- (i) manufacturer's identification/110mm uPVC pipe/Day/Month/Year/SS141;
or
 - (ii) manufacturer's identification/110mm uPVC pipe/Day/Month/Year/SS272

(as the case may be).
- (f) ensure that all associated couplings are manufactured by injection moulding method. Details for coupling are shown in Figure 11.1. The coupling shall comply to all tests as specified in the Singapore Standard SS:272 or its equivalent;
- (g) ensure that all associated couplings are of the dimensions and tolerances specified in Table 11.3.1(g) below;

Table 11.3.1(g) Dimension and tolerance of couplings

Coupling Length	180.0mm ± 2.0mm	
Internal Diameter	At the edges:	111.5mm + 0.2mm – 0.0mm
	At the centre:	111.0mm + 0.0mm – 0.2mm
Wall Thickness	Average Value:	3.2mm + 0.4mm – 0.0mm
	Individual Value:	3.0mm (min)
Wall thickness for a length of 15mm from both ends of the coupling shall increase to:	Average Value:	4.7mm + 0.3mm
	Individual Value:	4.2mm (min)

- (h) lay all pipes throughout in a straight run as far as practicable;
- (i) join all pipes together using a coating of solvent cement to both couplings and pipes;
- (j) where a bend is required to any pipe, use a factory-made bend of nominal diameter of 110mm and 50mm as illustrated in Figure 11.2(a) & (b) for 90° upturns (i.e. changing from the horizontal to vertical plane) and, unless otherwise advised by the Telecommunication Facility Co-ordination Committee, ensure that the pipe is clipped and flushed against the wall and rises up to a height of 1m above ground as illustrated in Figure 11.2(c) & (d);
- (k) where a straight pipe reducer is required to reduce the nominal diameter of the pipe from 110mm to 50mm or from 50mm to 25mm, use a pipe reducer in accordance with the specifications shown in Figure 11.3(a) & (b);
- (l) construct all pipes located below carriageways at a minimum depth of 1m;
- (m) construct all pipes located below side-tables or footpaths at a minimum depth of 1.2m;
- (n) ensure that all pipes that are buried in the ground under vehicular access are encased in 50mm concrete surround of Grade 20;
- (o) provide a nylon/polyethylene rope of 4-core or multi-strand type with overall diameter of 6mm in every pipe to facilitate cable pulling;

- (p) cap the unconnected ends of all pipes with rubber caps to prevent entry of earth, debris or cement except those ends terminating in manholes and those ends required to be sealed in another manner in accordance with this Code;
- (q) separate all pipes from power cables by no less than –
 - (i) 50mm of concrete surround of Grade 20; or
 - (ii) 300mm in well tamped earth;
- (r) where the underground pipes enter a building in a horizontal position, install a cable duct sealing module system such as MCT, SVT, ROX or BST types as described in Appendix 2 of the Guidelines for Info-communication Facilities in Buildings to prevent the ingress of water and construct a drain below the module system to allow for the drainage of water;
- (s) where the main distribution frame room or telecommunication equipment room is located in the basement of the building, ensure that the underground pipes do not lead directly into the room but connect to cable trays installed outside the main distribution frame room or telecommunication equipment room for entry via such cable trays into the room;
- (t) ensure that all pipes terminating inside the telecommunication risers are flush against the wall and rise up to a minimum height of 1m;
- (u) ensure that all lead-in pipes and the underground pipeline system are constructed in accordance with the practice as illustrated in Figure 11.34; and
- (v) ensure that all pipes are free of obstructing materials and substances to facilitate the deployment of cables by licensees.

11.4 Specific requirements for lead-in pipes

11.4.1 Every developer or owner who is required to provide lead-in pipes shall –

- (a) construct all lead-in pipes at a depth of no less than 1m from the base of (i.e. to under-cross) the existing or proposed roadside drain in accordance with the requirements of the relevant authorities except that where it is not possible for the lead-in pipes to under-cross the roadside drain, the owner shall consult IMDA on the construction of such lead-in pipes and comply with such requirements as may be imposed by IMDA;
- (b) orientate all lead-in pipes to face public roads and ensure that they are not constructed into State Land (i.e. backlane) or oriented to face the direction of trees, lamp posts, traffic lights, road signs, over-ground boxes (OG boxes) or other permanent obstacles;
- (c) ensure that the number of lead-pipes provided is equivalent to and no less than the number of pipes in the underground pipeline system entering the main distribution frame room;
- (d) where a common services tunnel (“CST”) or an equivalent type of tunnel system is constructed for the laying of telecommunication cables to building

developments (for example, the CST constructed in the Marina South new downtown area) –

- (i) construct and connect the lead-in pipes to the pipe-sleeves of the designated CST junction box adjacent to the building or building development and obtain all necessary approvals from the relevant authorities for such connection works; and
 - (ii) ensure that the number of lead-in pipes provided is equivalent to and corresponds with the number of pipe-sleeves of the designated CST junction box, notwithstanding the quantities of lead-in pipes specified in the relevant chapters of this Code; and
- (e) indicate the position of the lead-in pipes by a marker on the final ground level and indicate by such marker that these pipes are for telecommunication use.

11.4.2 The developer or owner is advised to consult the Telecommunication Facility Co-ordination Committee for guidance on the most suitable location and orientation for its lead-in pipes.

11.4.3 Figure 11.4 shows a typical layout of lead-in pipes in a gate pillar of a landed dwelling house.

11.5 Specific requirements for the provision of underground pipes

11.5.1 Every developer or owner who is required to provide underground pipes shall –

- (a) where multi-way pipes are used, ensure that spacers are installed;
- (b) where the laying of the underground pipes is obstructed by other services or deep culverts which require the under-crossing or over-crossing of such obstacles, lay the pipes in a gradual gradient of not less than 1:6 for pipes of nominal diameter of 110mm and not less than 1:3 for pipes of nominal diameter of 50mm; and
- (c) ensure that the number of underground pipes connecting from the lead-in pipes to the main distribution frame room or telecommunication equipment room is equivalent to and corresponds with the number of lead-in pipes.

11.5.2 Developers or owners are advised to refer to the testing procedures specified in Appendix 3 of the Guidelines for Info-communication Facilities in Buildings for the testing of the underground pipes.

11.6 Manholes and manhole covers

11.6.1 Where manholes of type JX2, MX1, MX2, MX3, MX4 or MX5 are constructed, the developer or owner shall comply with the specifications set out in Figures 11.5 to 11.33 in relation to such manholes.

11.6.2 Where it is necessary for larger manholes (type MX6 and above) or non-standard manholes or irregular manholes to be constructed, the developer or owner shall obtain the specifications for such manholes from the Telecommunication Facility Co-ordination Committee.

11.6.3 Before any concrete is laid for the construction of any manhole, the developer or owner shall ensure that –

- (a) the bottom of the excavation is properly levelled and consolidated;
- (b) the bottom of the excavation is kept dry by providing a sump-hole to accommodate water pump, and where necessary provide a layer of 150mm thick hard-core materials;
- (c) pipes are cast on site and that manhole fittings are placed as the construction proceeds;
- (d) uPVC pipes with a flared mouth at one end and which comply with the Singapore Standard SS:272 are used for entry into the wall of the manhole;
- (e) the underground pipes enter each manhole in the manner shown in Figures 11.5 to 11.14, 11.19 to 11.22 & 11.27 to 11.33, and at such depths as to ensure a minimum clearance of 450mm above the floor level and 350mm below the roof unless otherwise specified;
- (f) the manhole is constructed at a depth which allows for a concrete (1:2:4) shaft wall of varying height to be constructed for the various manhole sizes shown in Figures 11.15 to 11.18 & 11.23 to 11.26;
- (g) the concrete used for filling the recess of the manhole frame and cover is of Grade 20 and that such filling is flush with the top of the cover, and where heavy duty frame and cover is used, ensure that the concrete is filled up to the ribs without covering the ribs;
- (h) manhole walls are fair faced and not rendered, and that all projections or cavities in the manhole walls are removed or filled with cement mortar respectively;
- (i) the manhole walls are not coated with cement or cement sand wash;
- (j) the floor of the manhole is given a 20mm rendering of cement mortar with fall towards the sump-hole from all directions;
- (k) 1 uPVC pipe of nominal diameter of 50mm with a 1-way trap is constructed at the neck of the manhole and connected to the nearest drain that is situated at a lower level than the manhole; and
- (l) only approved formwork is used in the construction of manholes;

11.6.4 The manhole covers for all manholes shall comply with the following requirements –

- (a) where the manhole is constructed under carriageways or vehicular access areas, a heavy duty manhole cover which complies with the Singapore Standard SS 30 Grade A1 shall be used for such manhole;
- (b) where the manhole is constructed under turfed areas or pedestrian footways, a medium duty manhole cover which complies with the Singapore Standard SS 30 Grade B shall be used for such manhole; and

- (c) in all cases, the manhole covers shall be designed to fulfil the following requirements –
 - (i) there should be at least 4 gas discharge valves to ensure that there are sufficient vents to allow gas to be discharged from the manhole;
 - (ii) the gas discharge valves should be able to release gas automatically once the manhole is accumulated with gas;
 - (iii) there should be a separate gas checking hole (in addition to the gas discharge valves) to allow gas companies to insert their probing devices to check if there is gas accumulated in the manholes;
 - (iv) the gas discharge valves and gas checking hole should have caps so as to minimise the risk of mosquitoes getting into and breeding inside the manholes. The caps should be secured to prevent them from being dislodged; and
 - (v) one side of the manhole cover should be hinged on the inside to keep it anchored to the ground to prevent the manhole cover from becoming a harmful projectile in the event of a major gas leak which cannot be sufficiently discharged by the gas discharge valves, resulting in gas accumulation and explosion
- 11.6.5 The developer or owner may choose to install pre-cast manholes as an alternative to constructing the manholes.
- 11.6.6 The developer or owner may purchase manhole frames, covers and channel brackets directly from suppliers or from licensees. Every developer or owner shall ensure that the manhole covers which he provides do not bear the name of any licensee.

FIGURE 11.1: INJECTION MOULDED UPVC COUPLING FOR 110MM NOMINAL SIZE UPVC PIPE

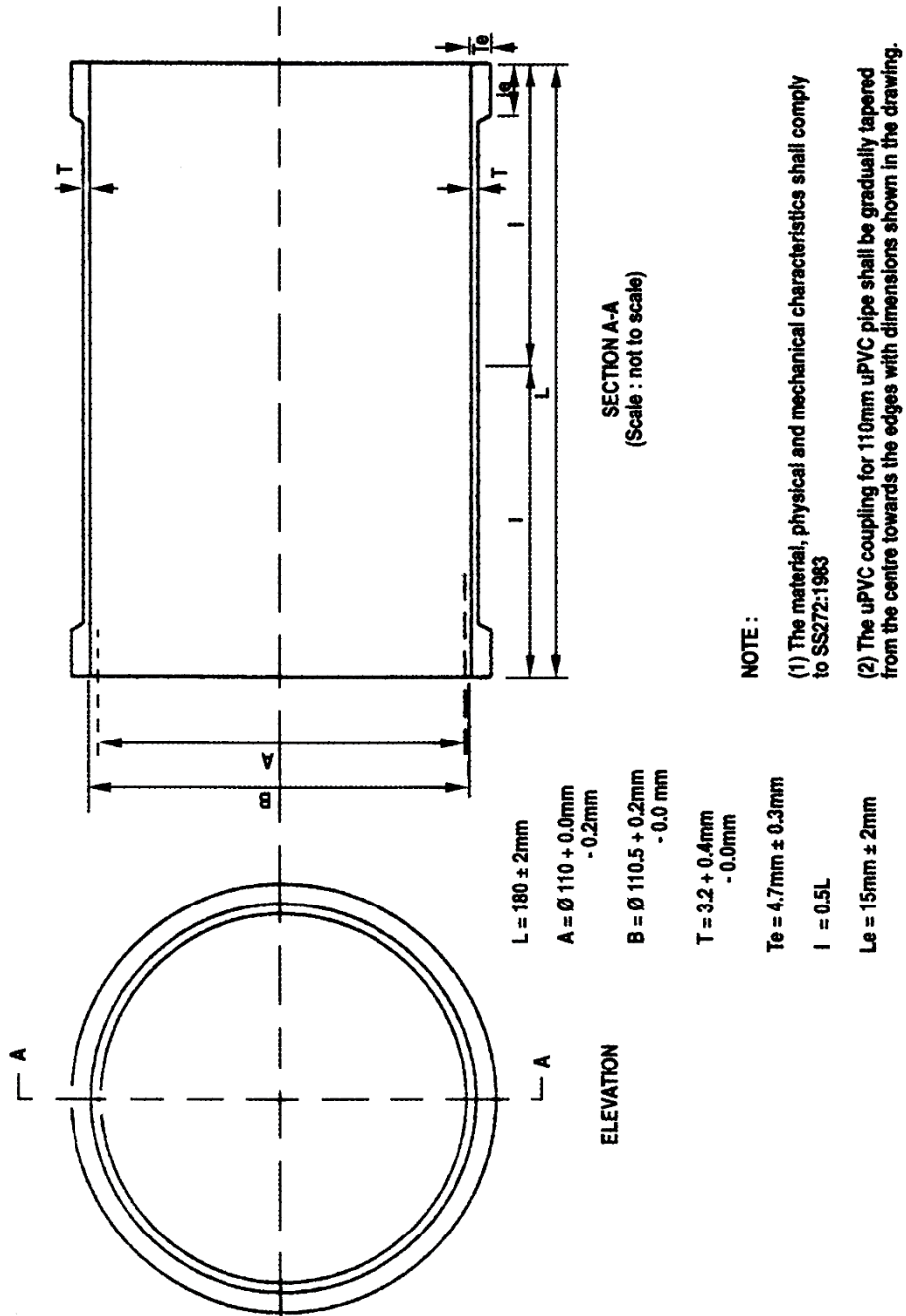

FIGURE 11.2(a): 110MM DIAMETER UPVC BEND PIPE

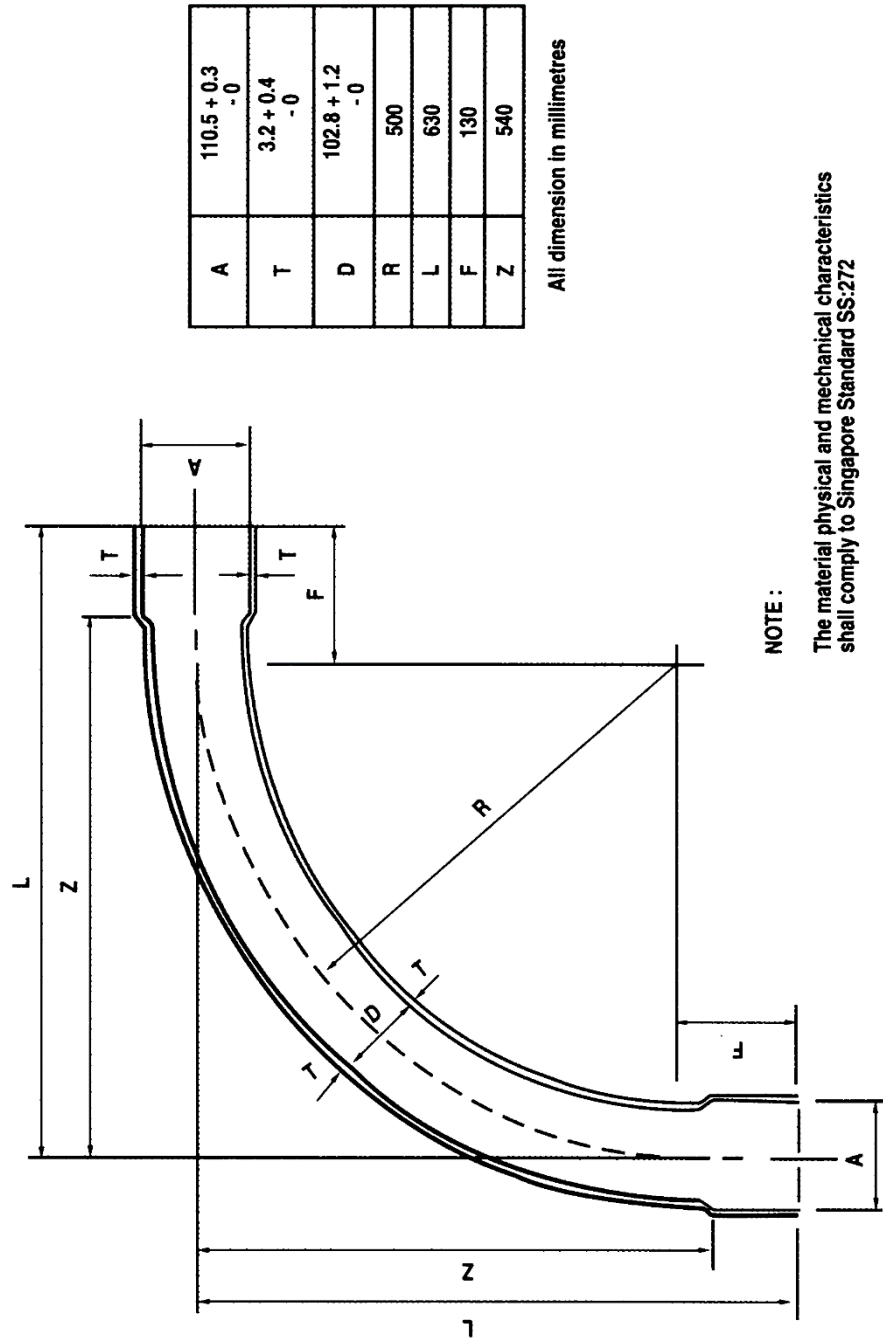

FIGURE 11.2(b): 50MM DIAMETER UPVC BEND PIPE

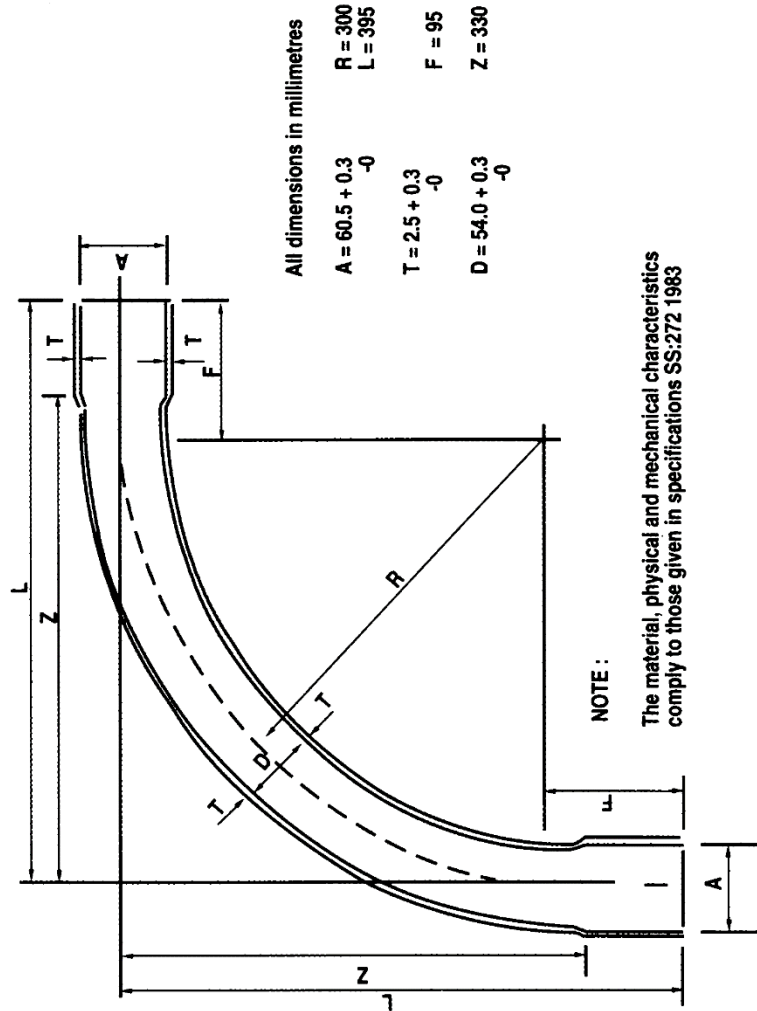

FIGURE 11.2(c): DETAILS OF LEAD-IN PIPES WITH BEND PIPES

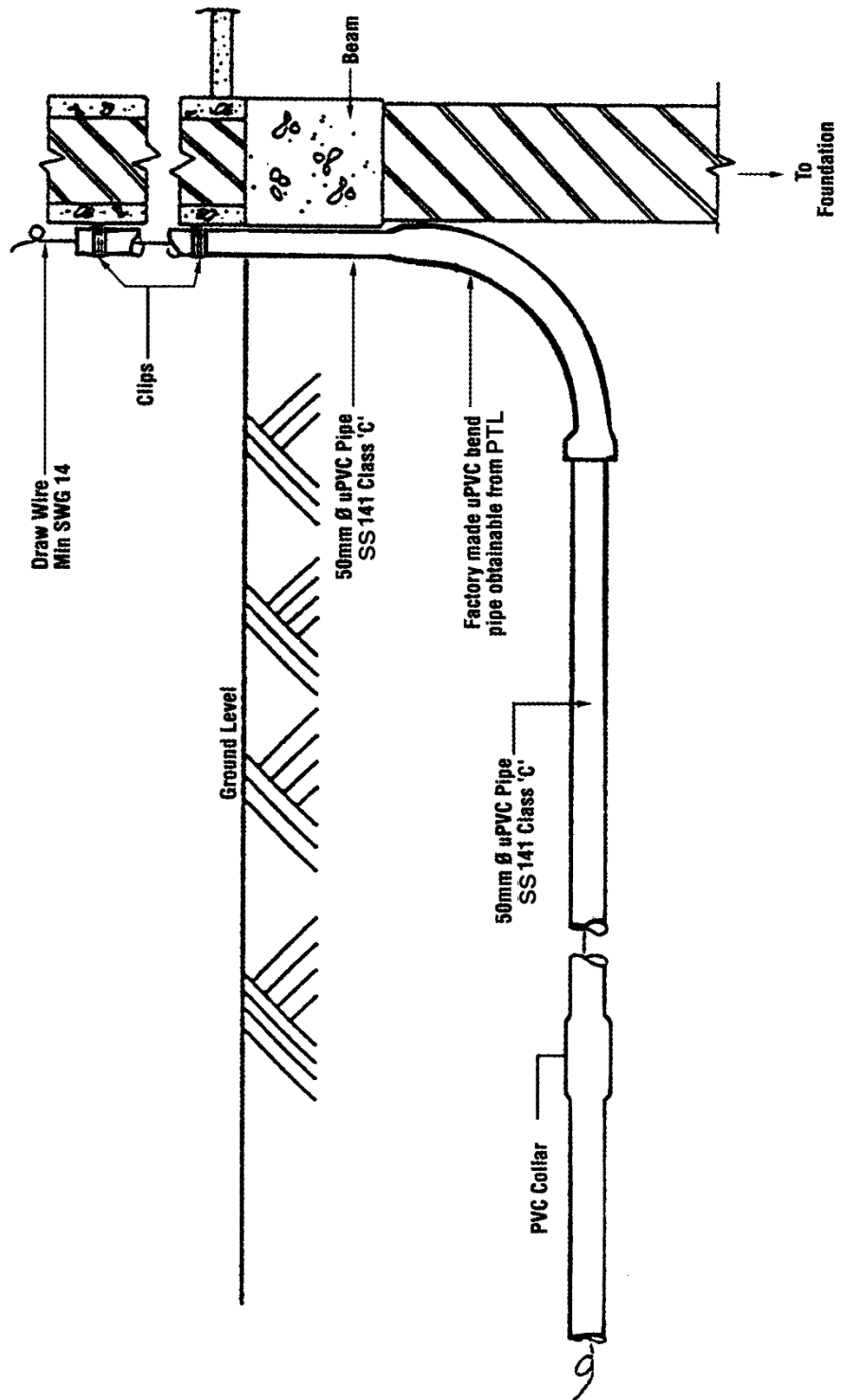

FIGURE 11.2(d): DETAILS OF LEAD-IN PIPES WITH BEND PIPES

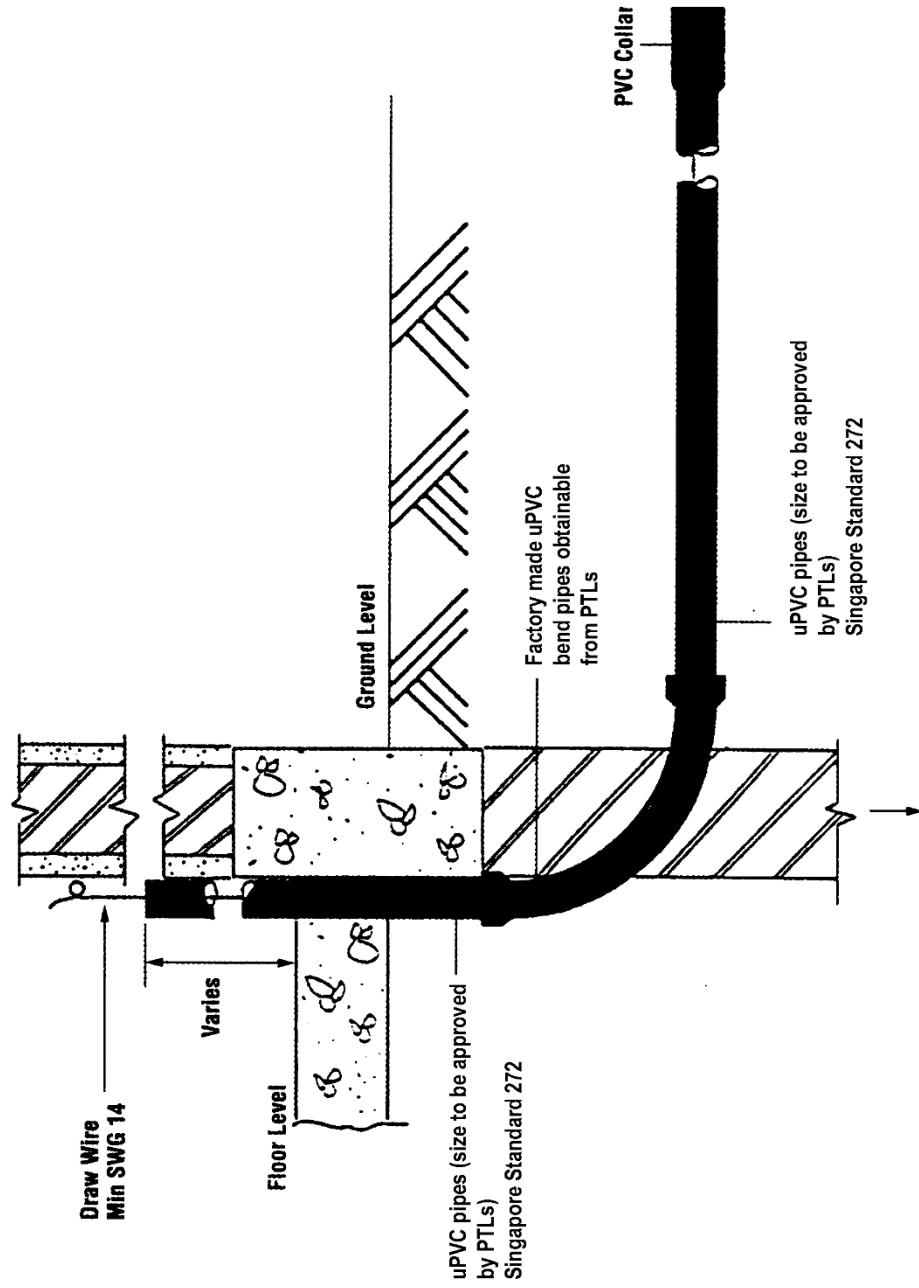
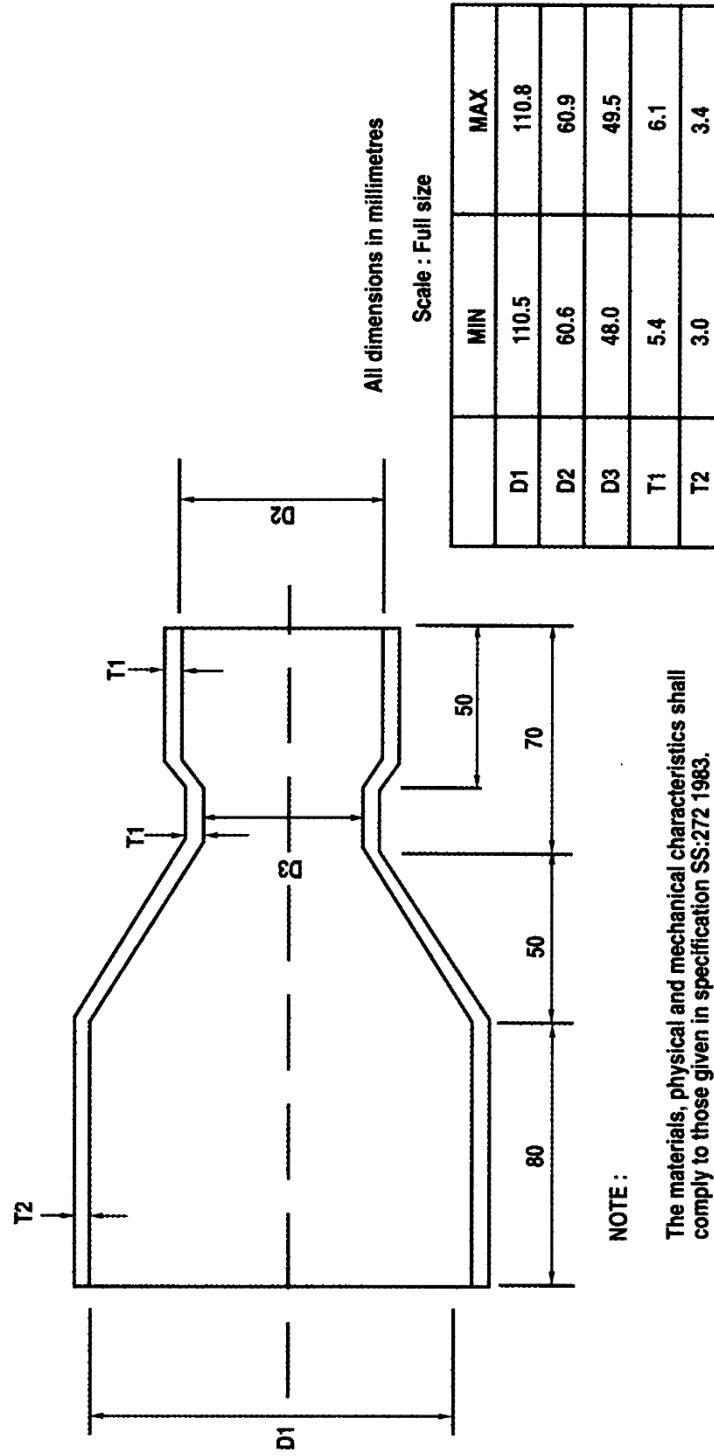

FIGURE 11.3(a): REDUCER FOR 110MM TO 50MM DIAMETER NOMINAL SIZE UPVC PIPE



All dimensions in millimetres

Scale : Full size

**FIGURE 11.3(b): REDUCER FOR 50MM TO 25MM NOMINAL SIZE
UPVC PIPE**

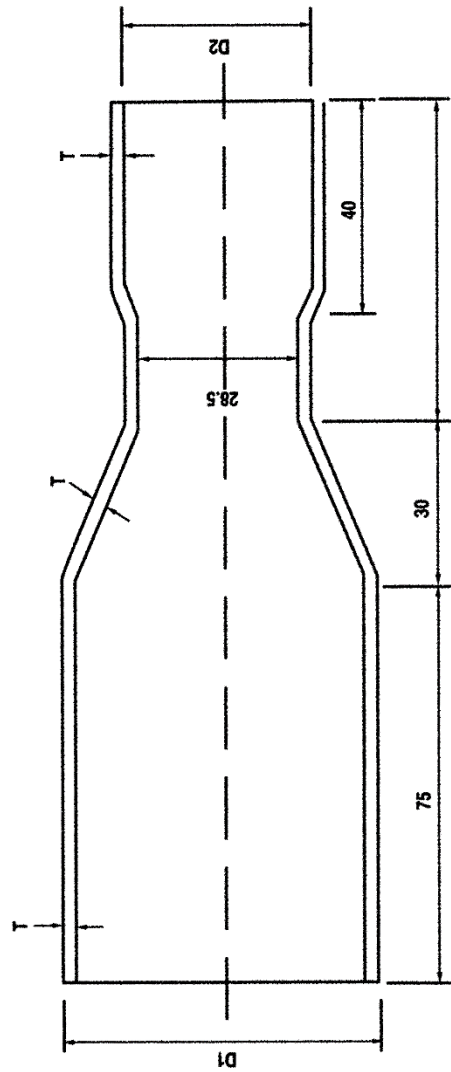

NOTE :

The materials, physical and mechanical characteristics shall comply to those given for 110mm Ø nominal size uPVC pipe in accordance to Singapore Standard SS:272 1983.

All dimensions in millimetres

	MIN	MAX
D1	60.2	60.5
D2	33.7	34.0
T	2.7	3.0

FIGURE 11.4: LOCATION OF LEAD-IN PIPES IN GATE PILLAR

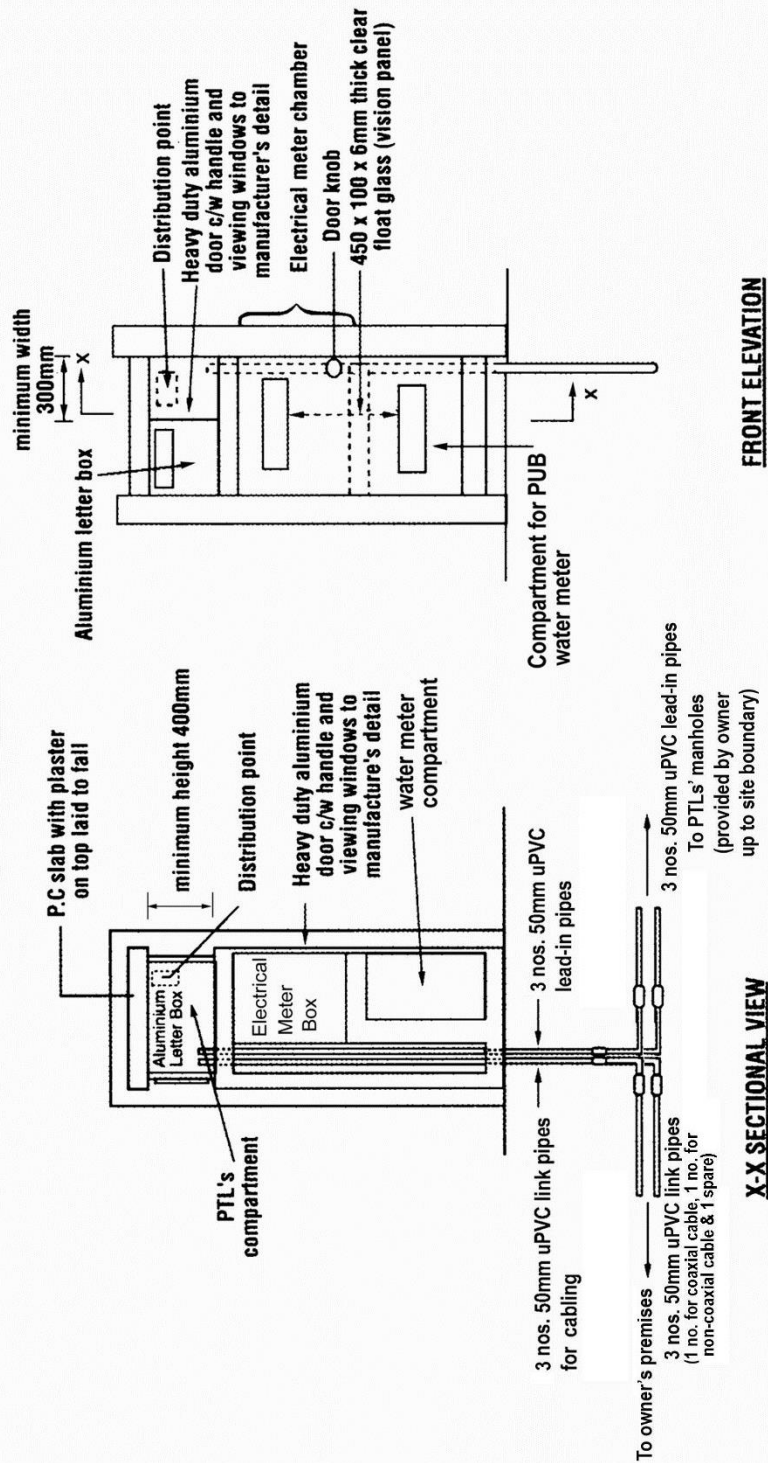

FIGURE 11.5: MANHOLE DRAWINGS - TYPE JX2

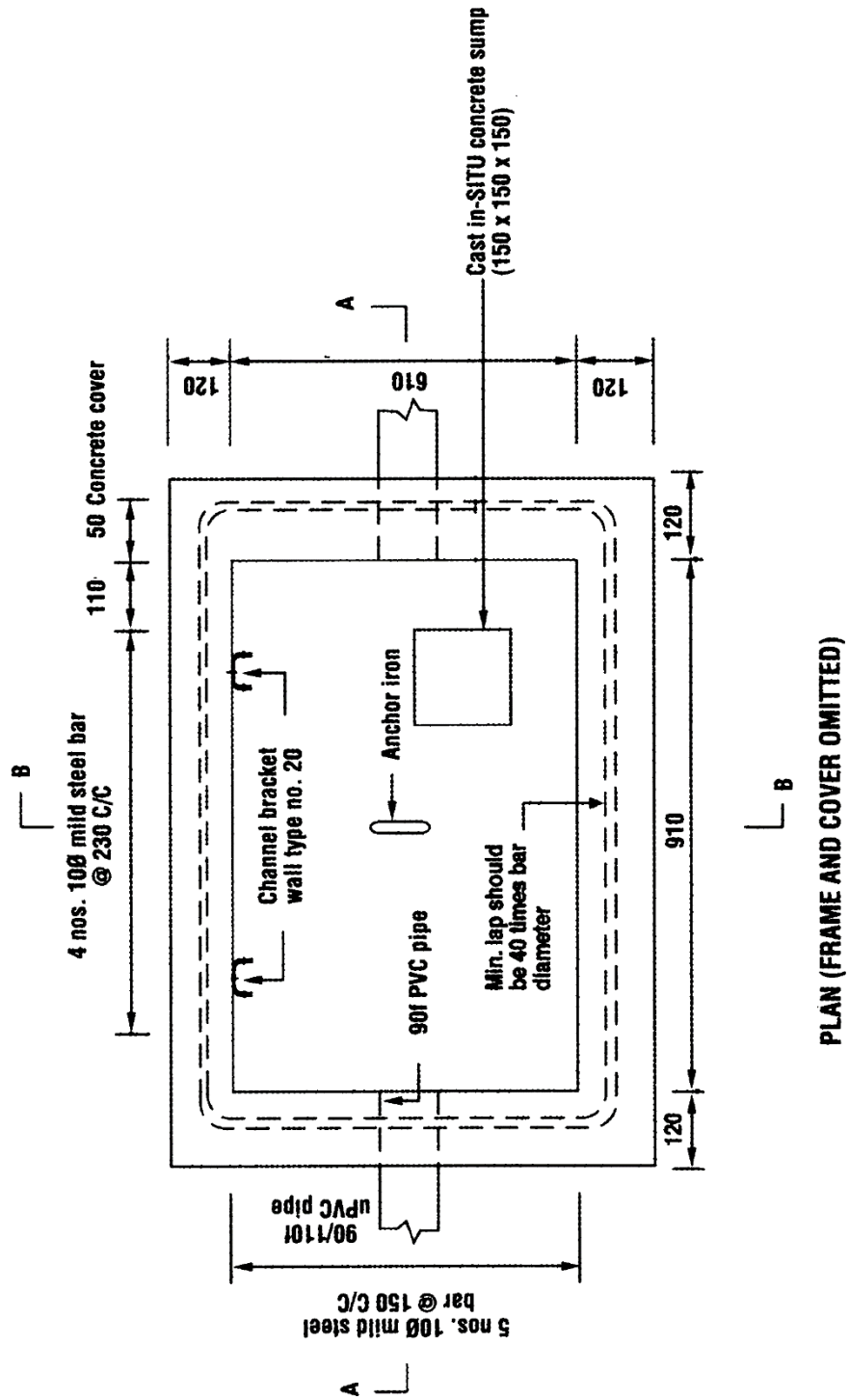

FIGURE 11.6: MANHOLE DRAWINGS - TYPE JX2

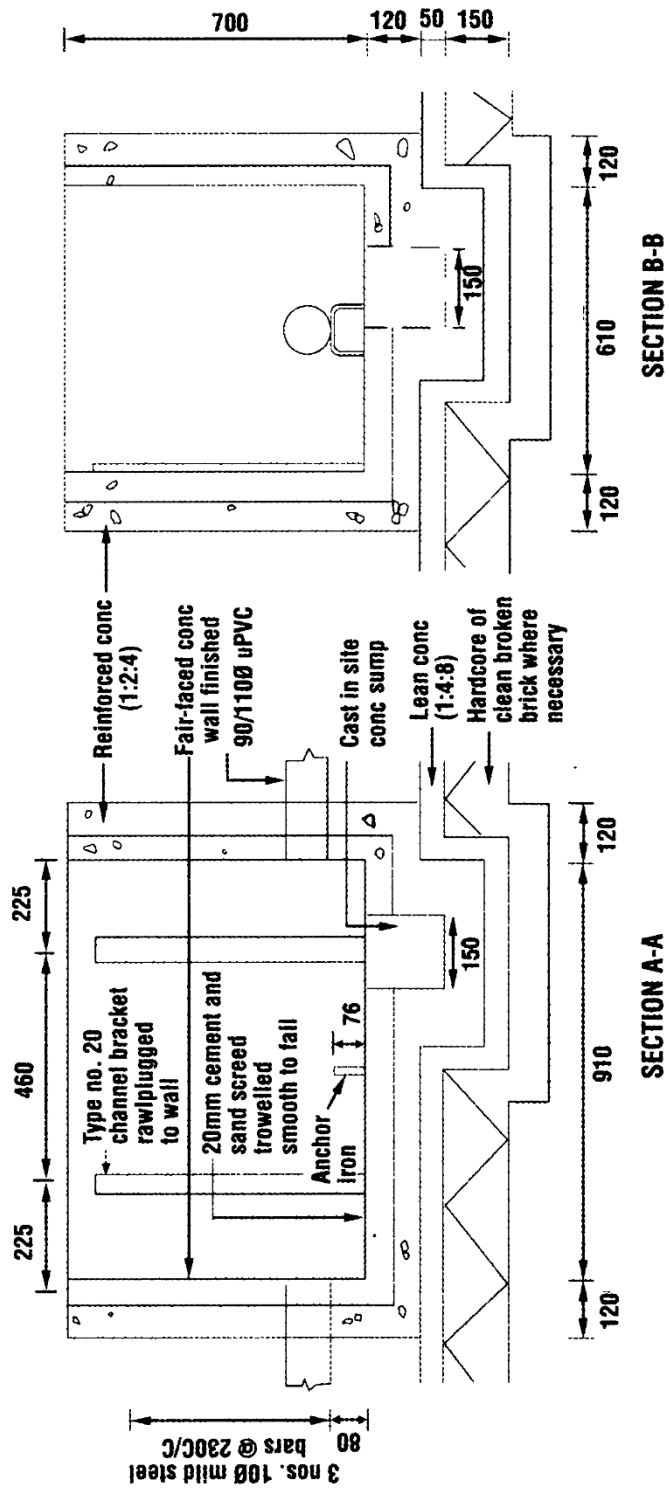

FIGURE 11.7: MANHOLE DRAWINGS - TYPE MX1

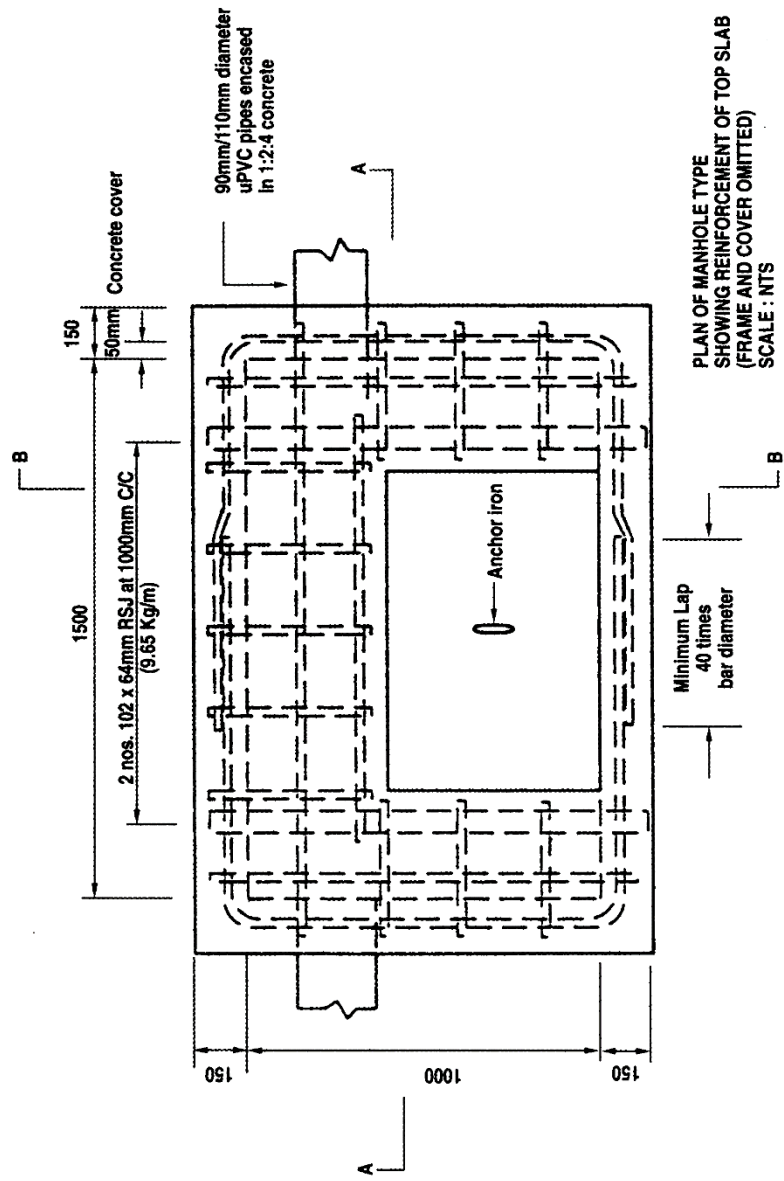

FIGURE 11.8: MANHOLE DRAWINGS - TYPE MX1

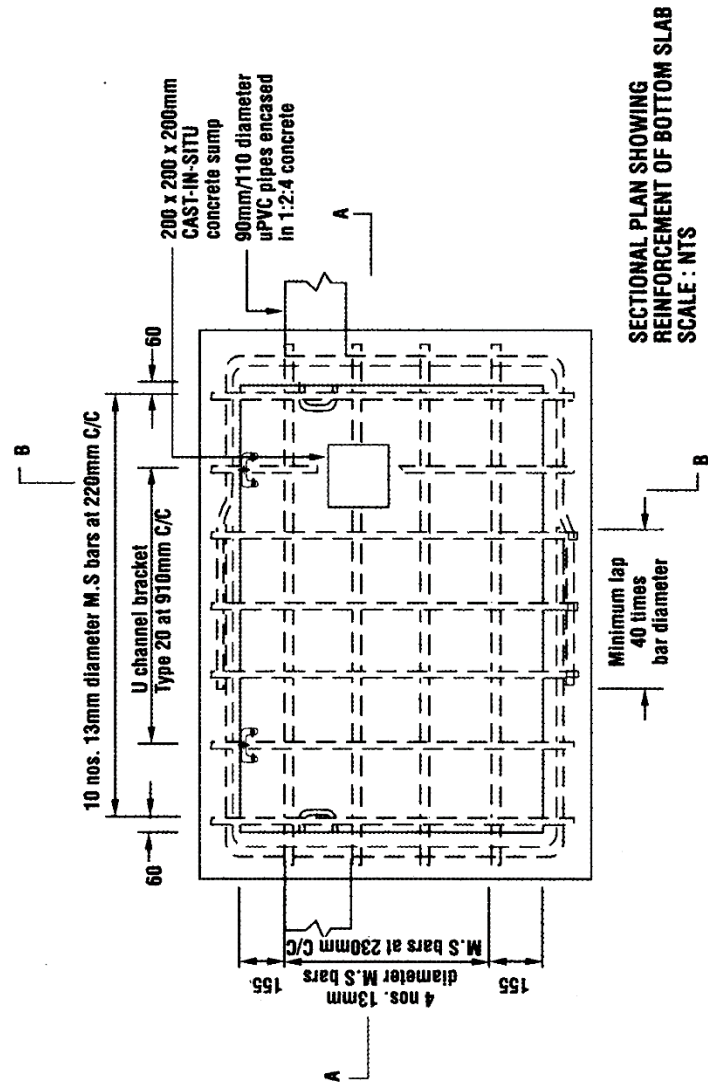

FIGURE 11.9: MANHOLE DRAWINGS - TYPE MX1

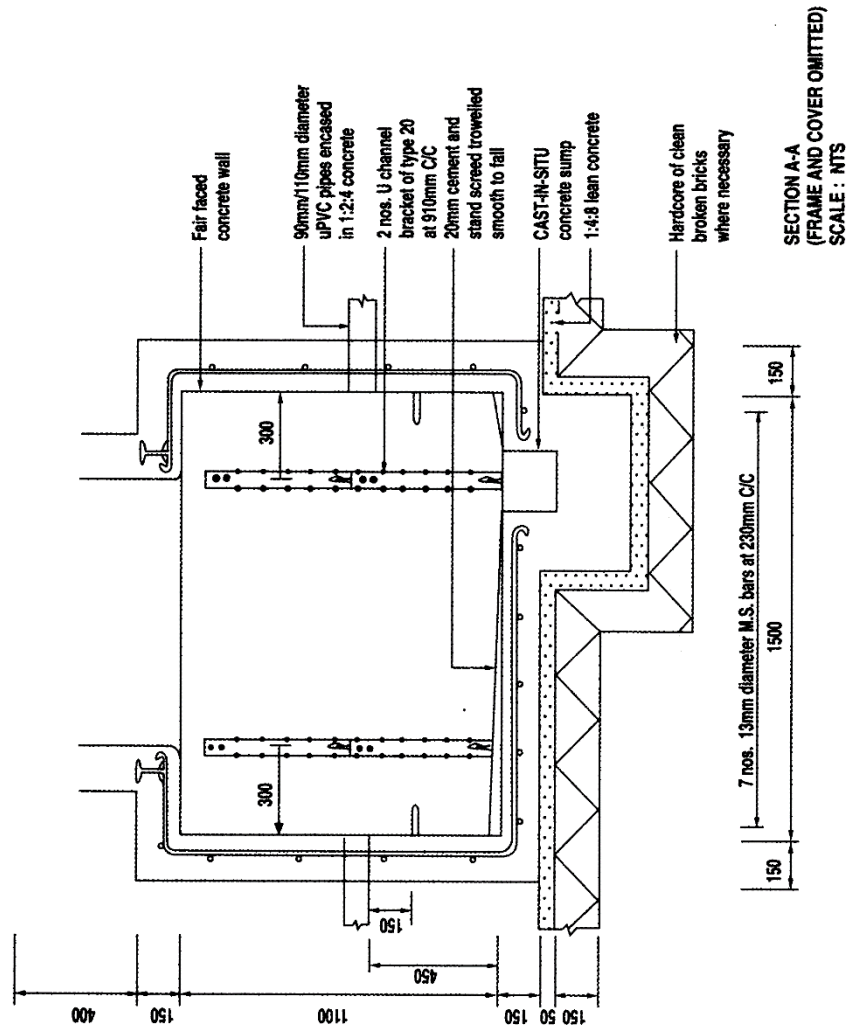
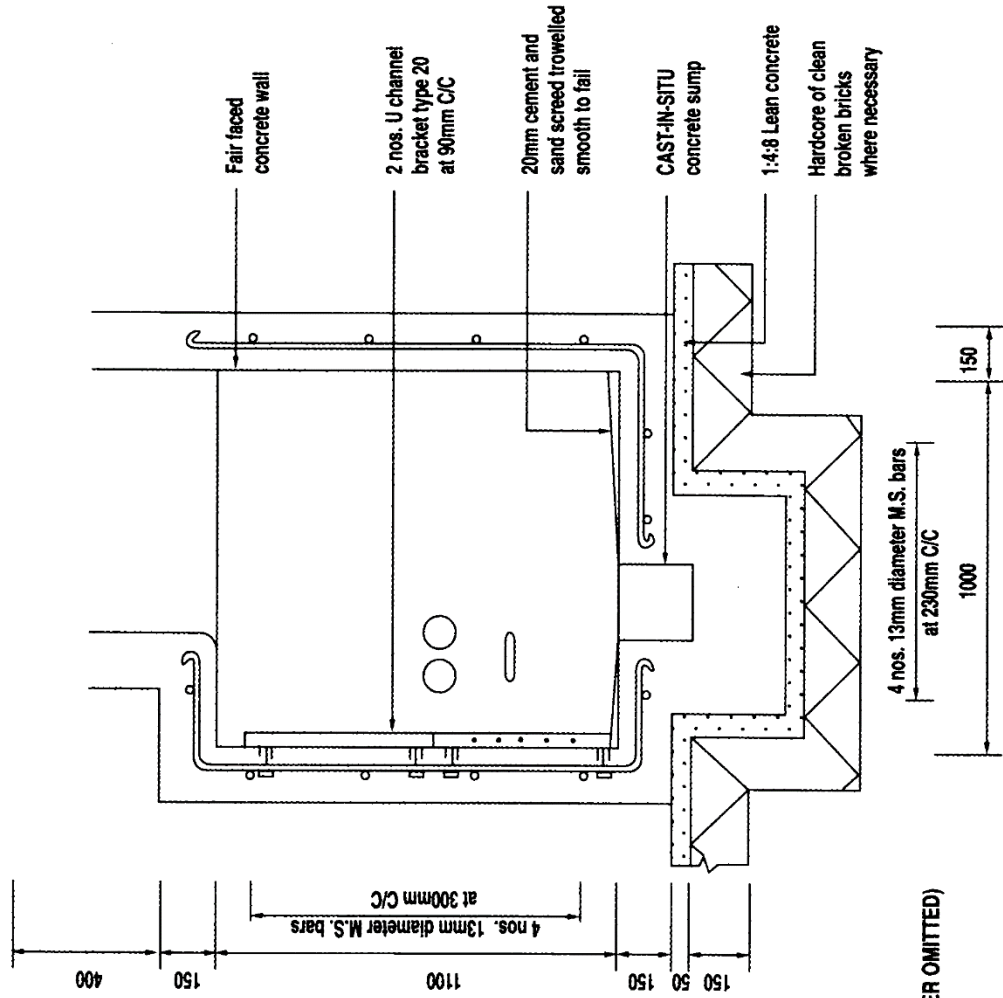

FIGURE 11.10: MANHOLE DRAWINGS - TYPE MX1



**SECTION B-B
(FRAME AND COVER OMITTED)
SCALE : NTS**

FIGURE 11.11: MANHOLE DRAWINGS - TYPE MX2

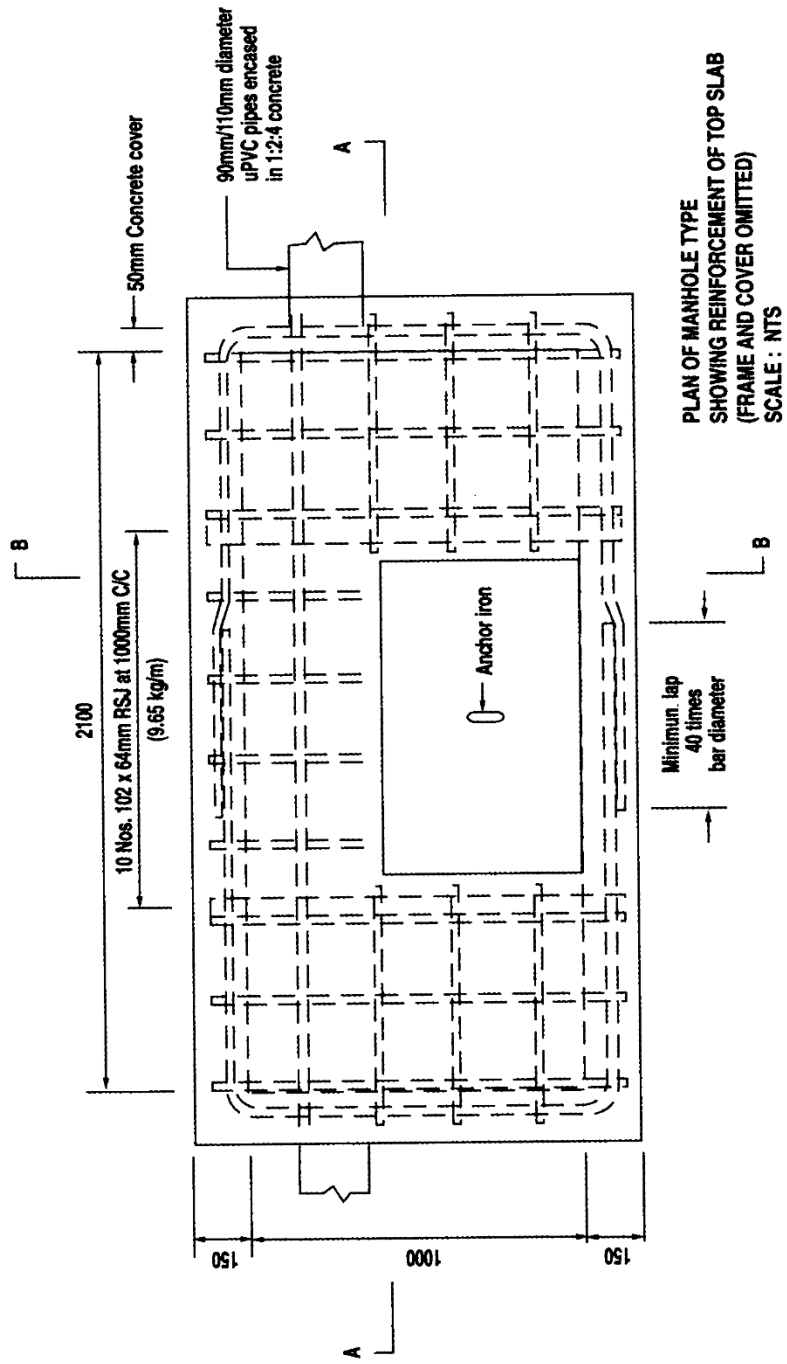

FIGURE 11.12: MANHOLE DRAWINGS - TYPE MX2

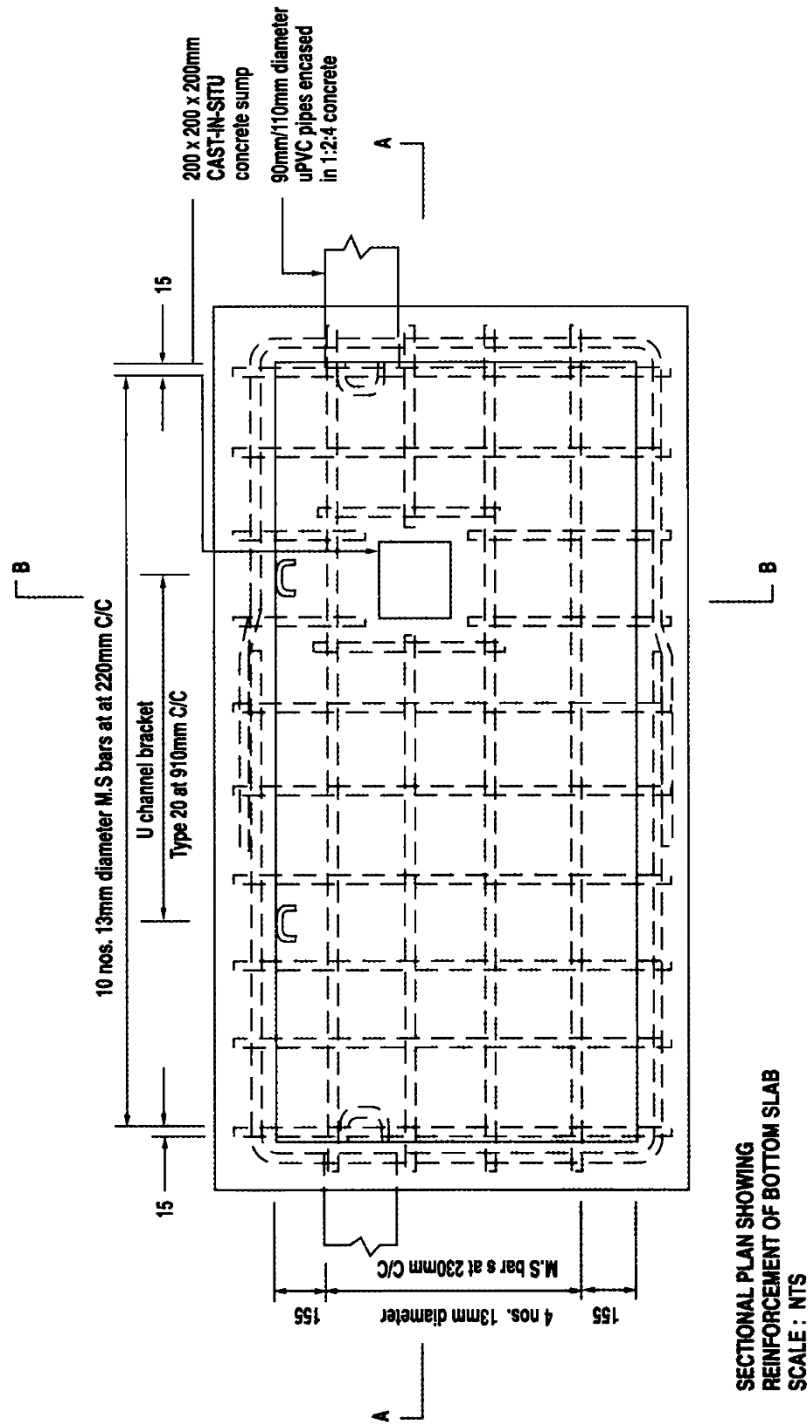
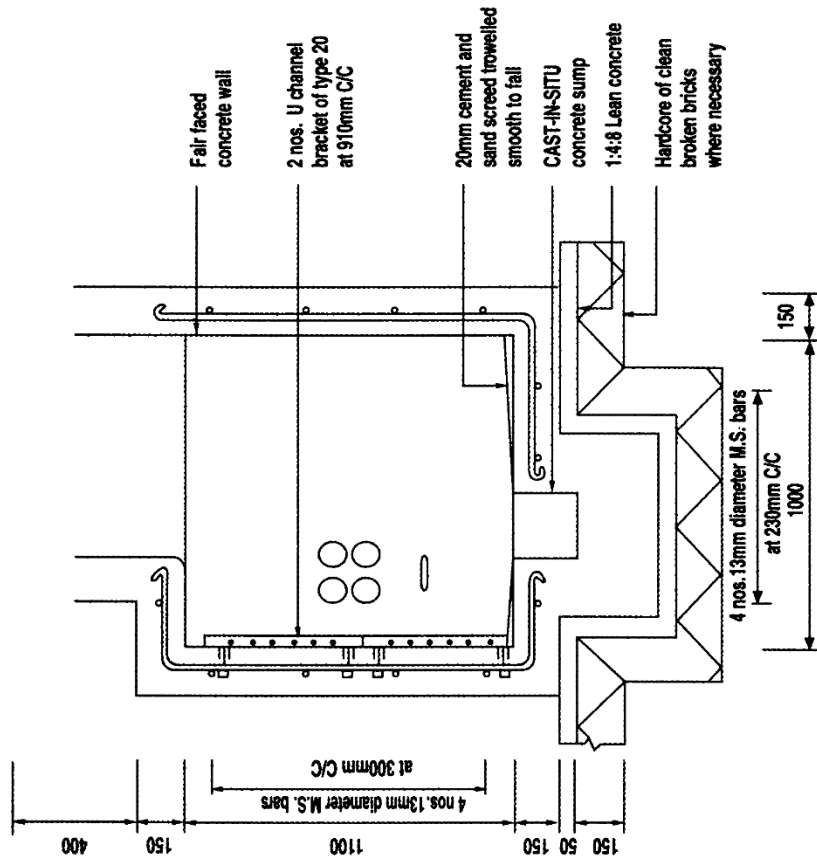
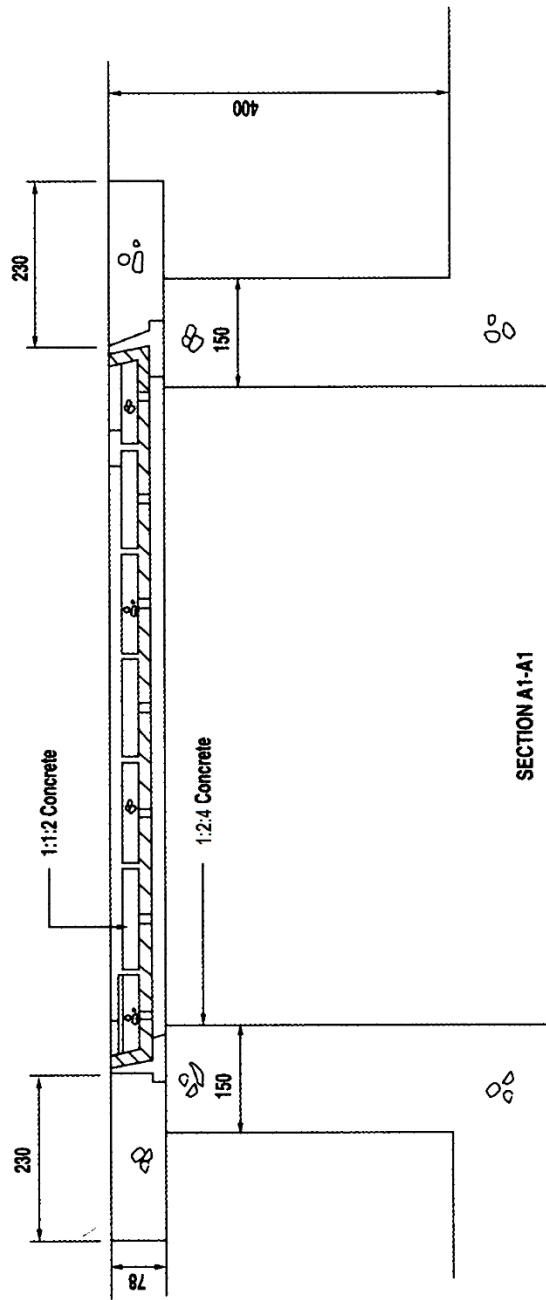

FIGURE 11.14: MANHOLE DRAWINGS - TYPE MX2



SECTION B-B
 (FRAME AND COVER OMITTED)
 SCALE : NTS

FIGURE 11.15: MANHOLE DRAWINGS - TYPE MX1 & MX2



SECTION A1-A1
DETAIL OF MANHOLE SHAFT
FOR TYPE MX 1 AND MX 2
WITH MEDIUM DUTY FRAME
AND COVER
SCALE : NTS

FIGURE 11.16: MANHOLE DRAWINGS - TYPE MX1 & MX2

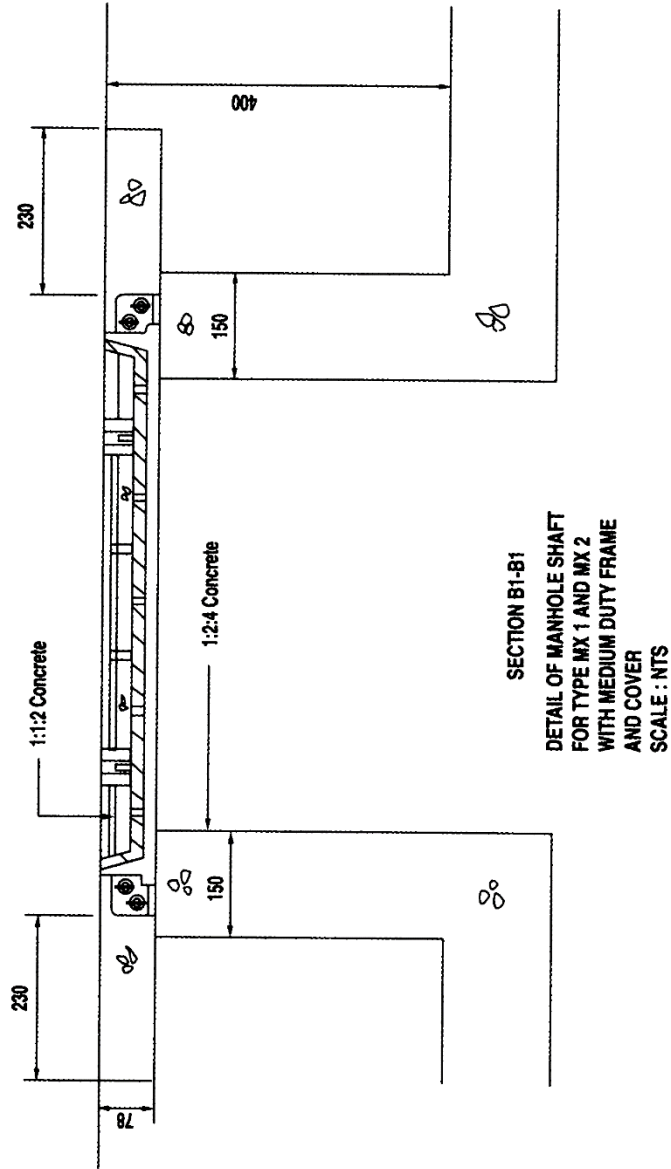

FIGURE 11.18: MANHOLE DRAWINGS - MX1 & MX2

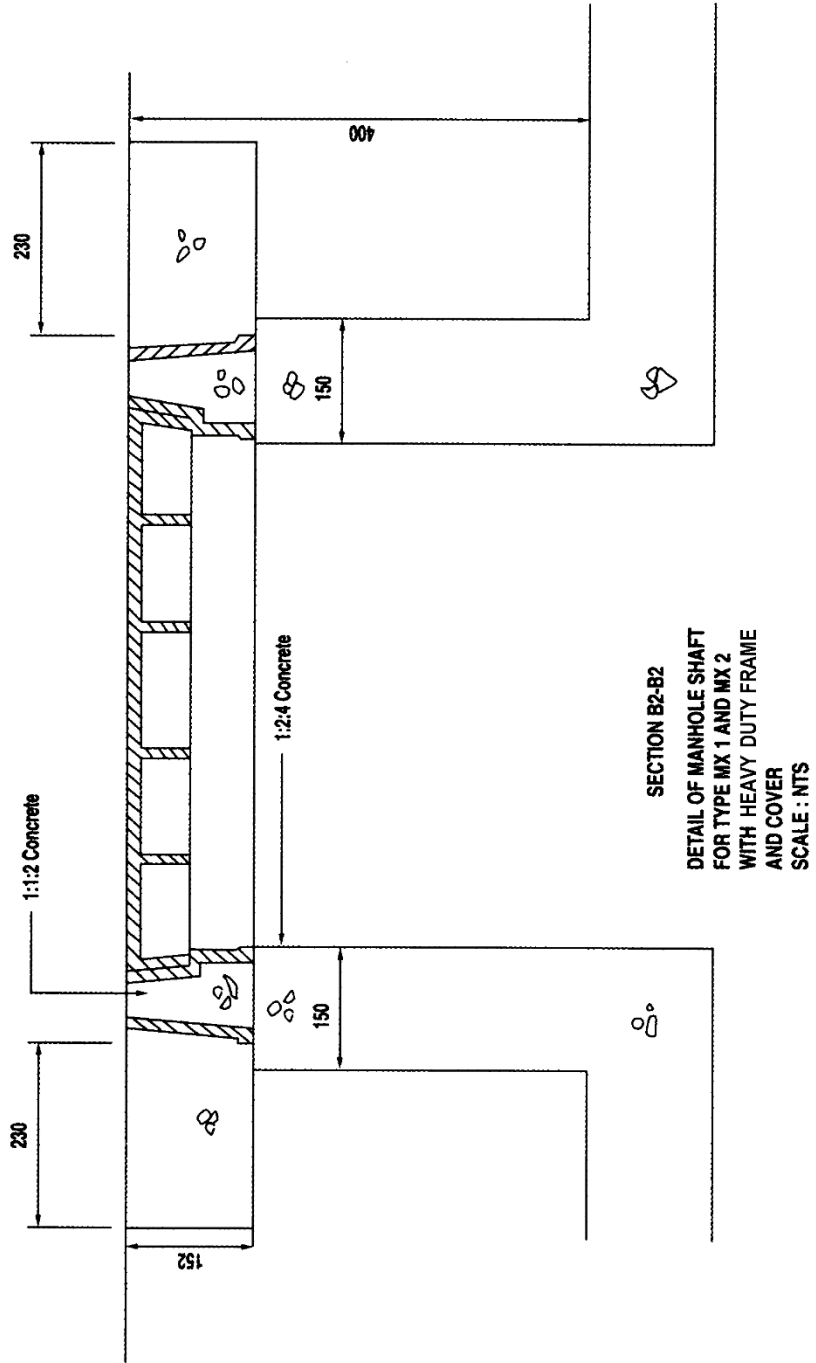

FIGURE 11.19: MANHOLE DRAWING - TYPE MX3

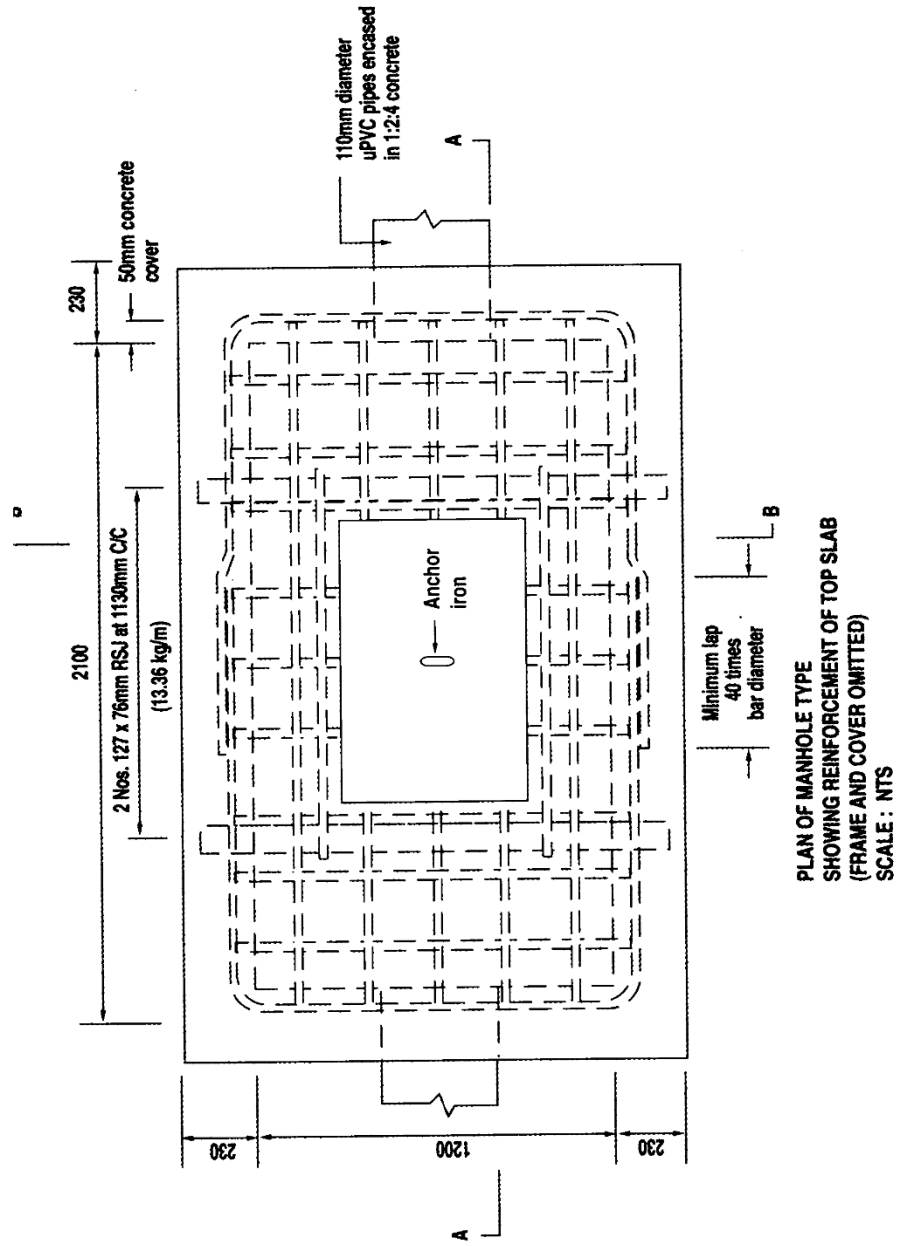

FIGURE 11.20: MANHOLE DRAWINGS - TYPE MX3

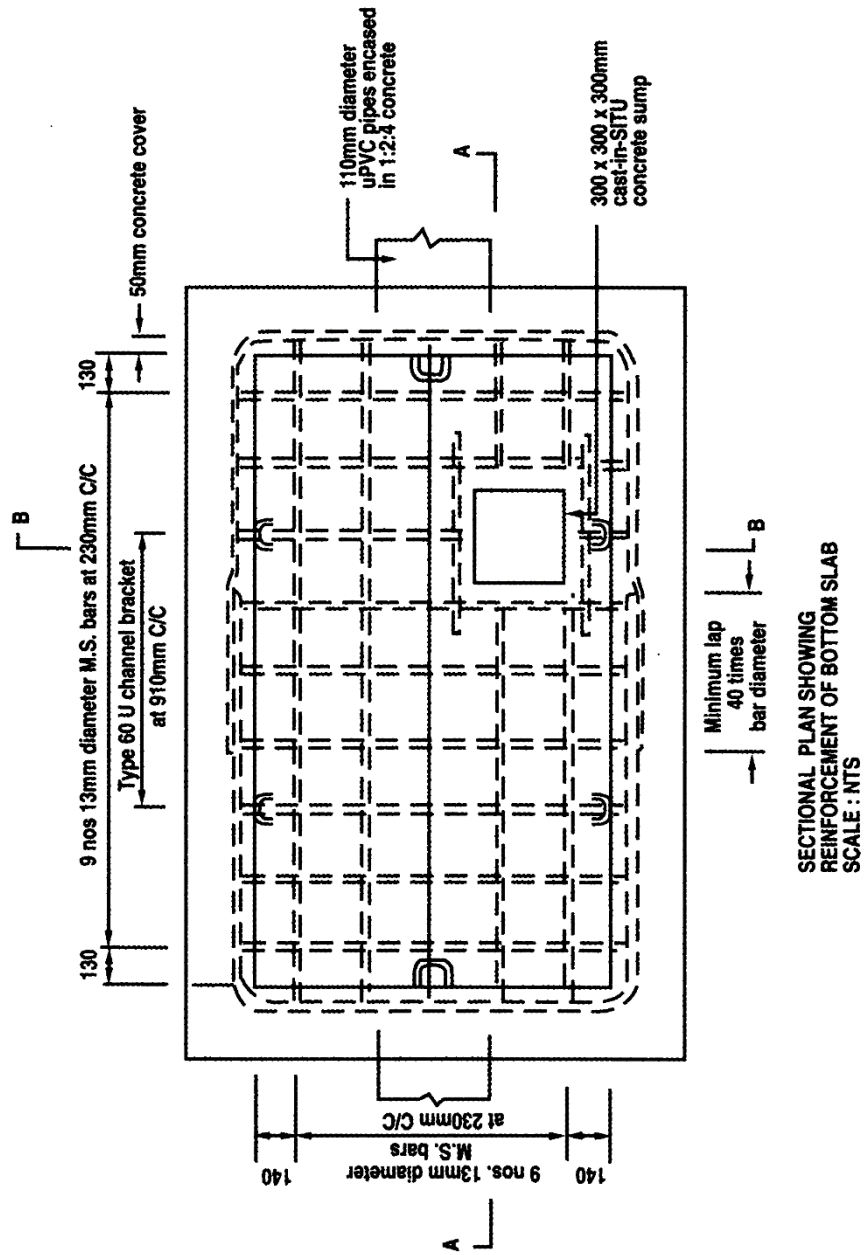

FIGURE 11.21: MANHOLE DRAWINGS - TYPE MX3

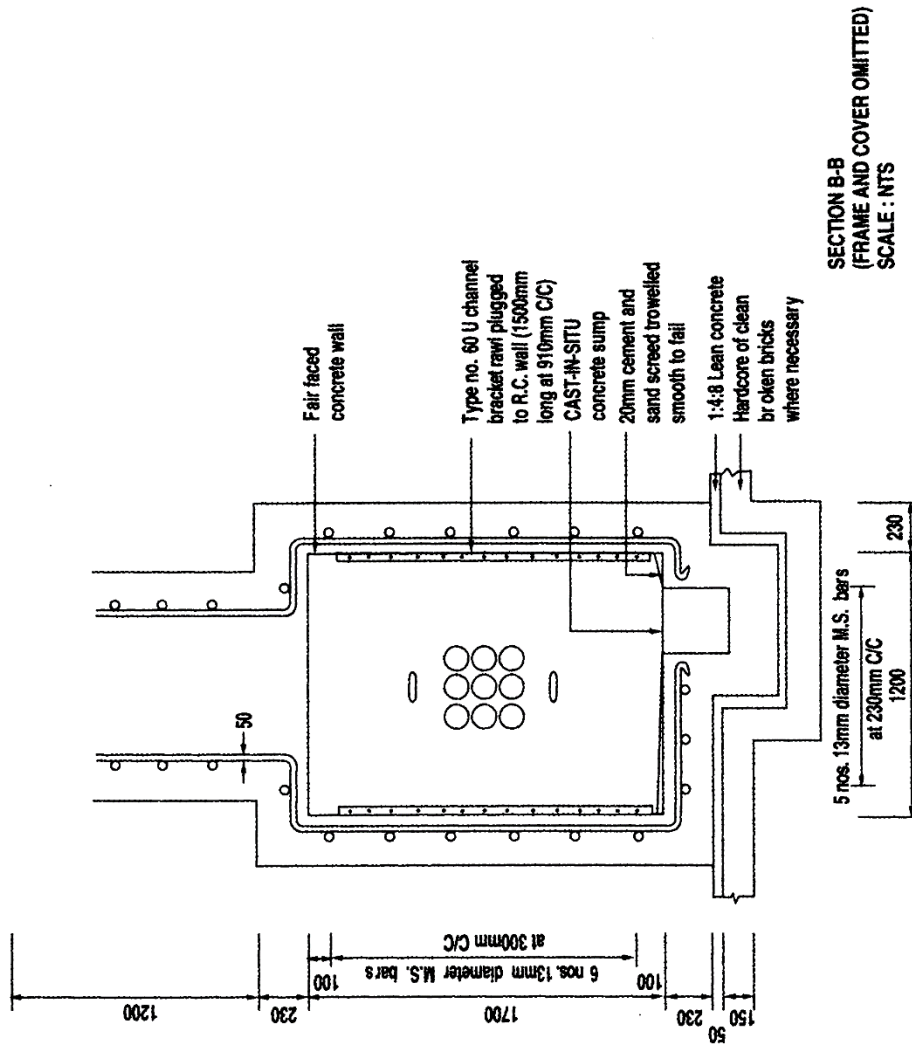
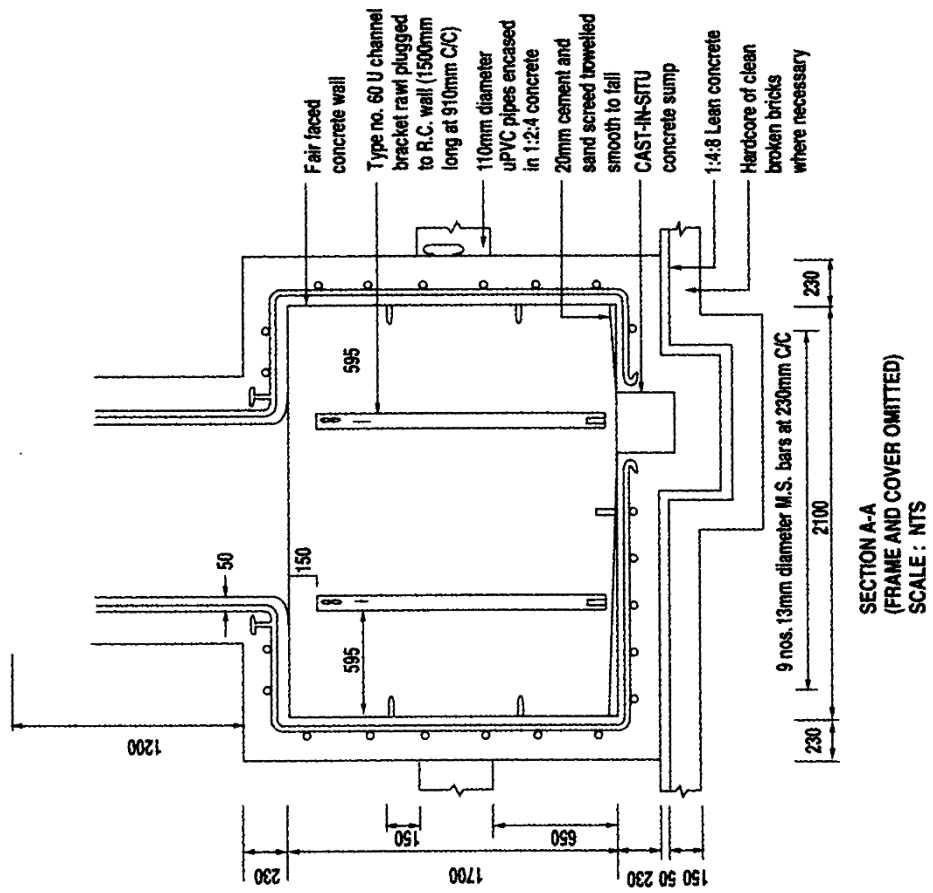

FIGURE 11.22: MANHOLE DRAWINGS - MX3



**SECTION A-A
(FRAME AND COVER OMITTED)
SCALE : NTS**

FIGURE 11.23: MANHOLE DRAWINGS - TYPE MX3 & ABOVE

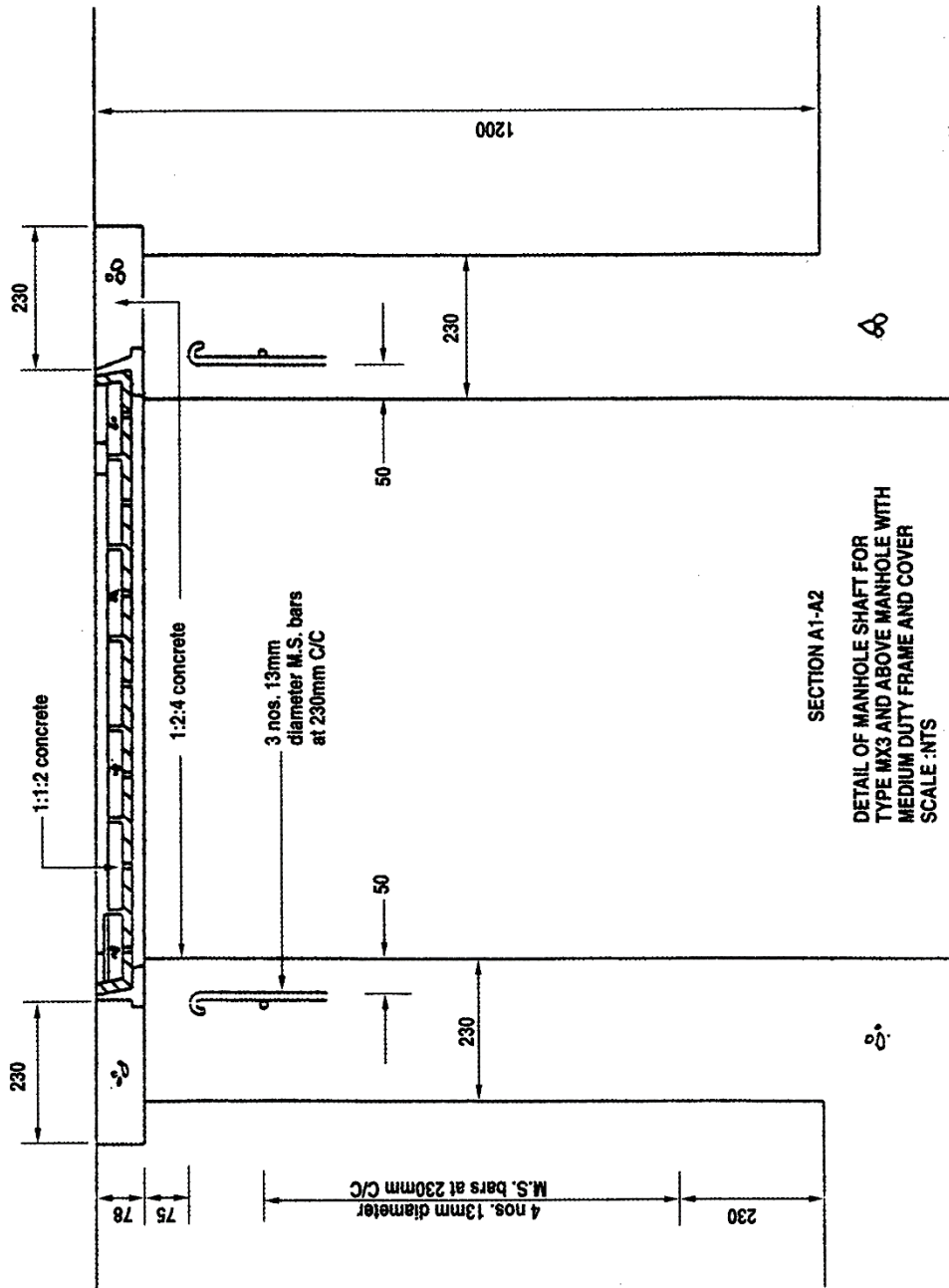
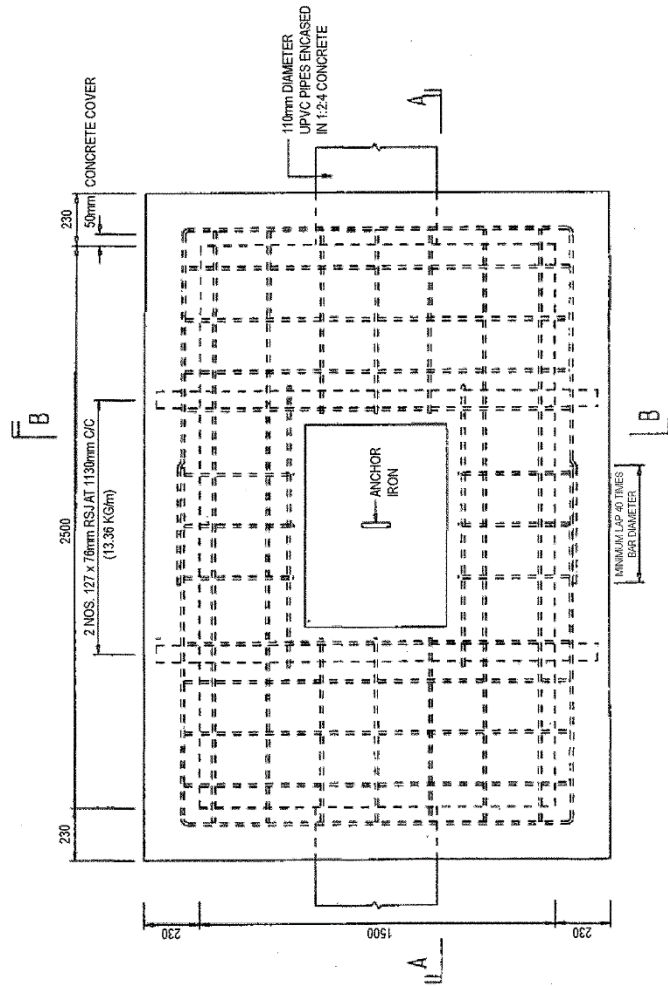
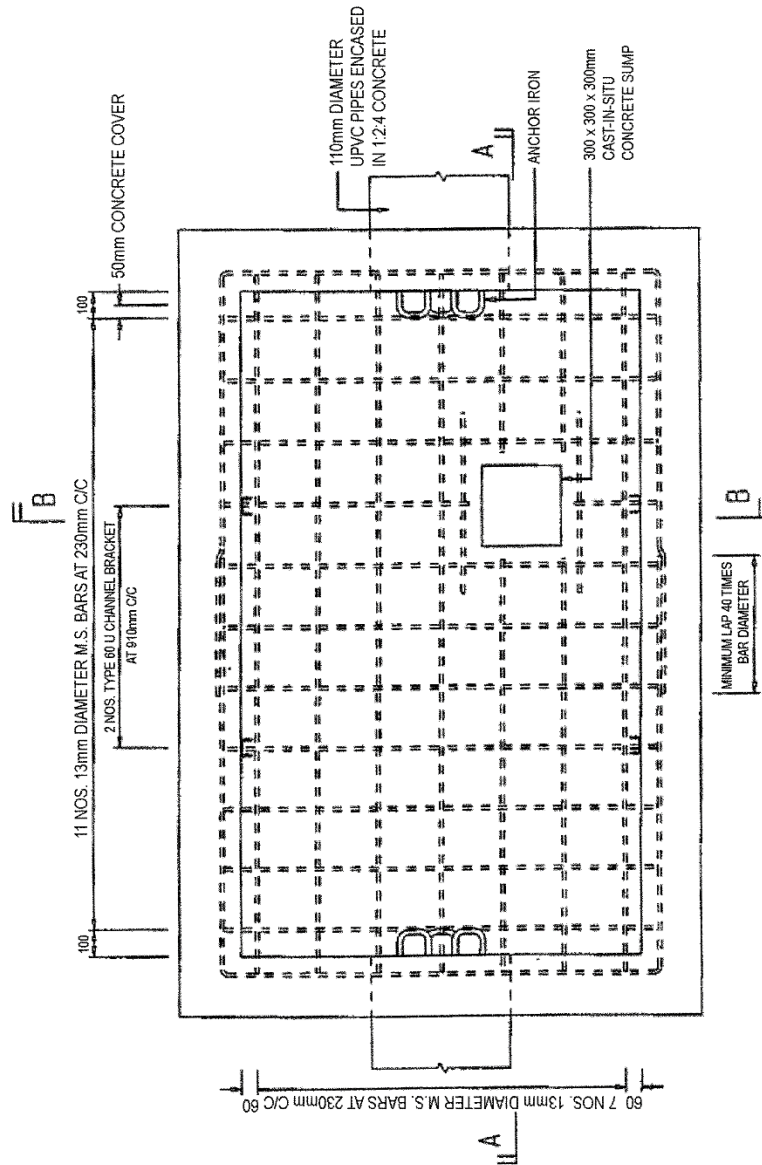

FIGURE 11.27: MANHOLE DRAWINGS - TYPE MX4



PLAN OF MANHOLE
SHOWING REINFORCEMENT OF TOP SLAB
(FRAME AND COVER OMITTED)
SCALE: NTS

FIGURE 11.28: MANHOLE DRAWINGS - TYPE MX4



**SECTIONAL PLAN OF MANHOLE
SHOWING REINFORCEMENT OF BOTTOM SLAB
SCALE: NTS**

FIGURE 11.29: MANHOLE DRAWINGS - TYPE MX4

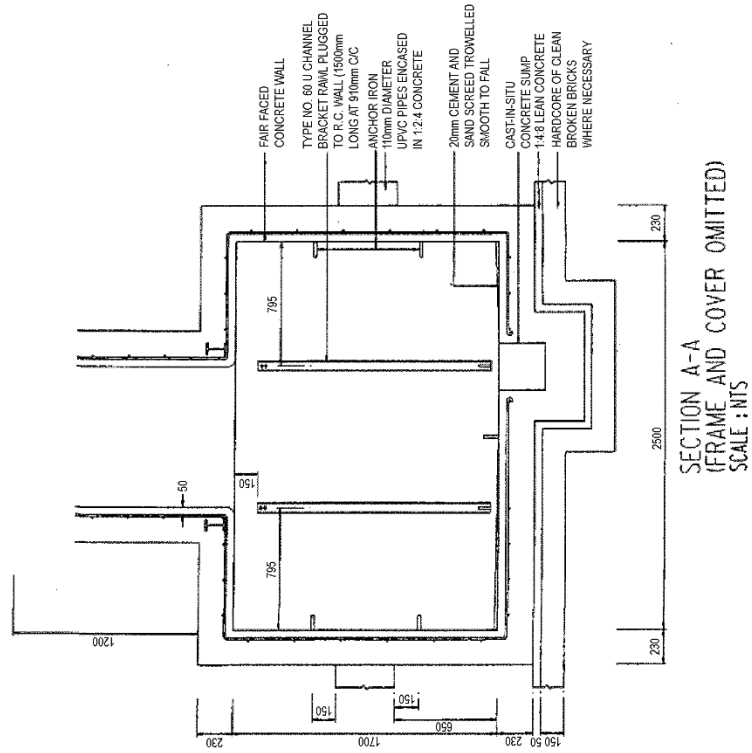
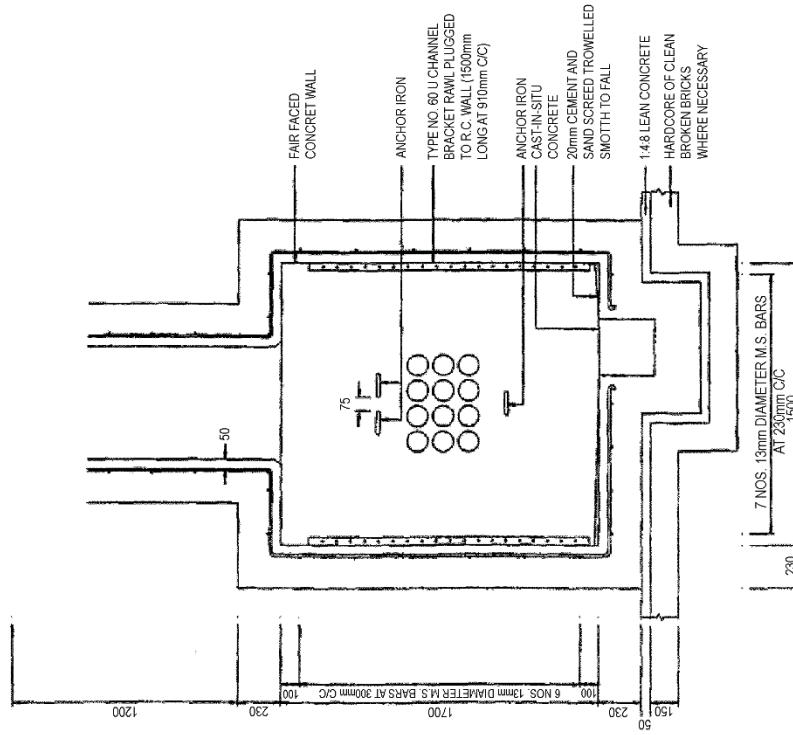
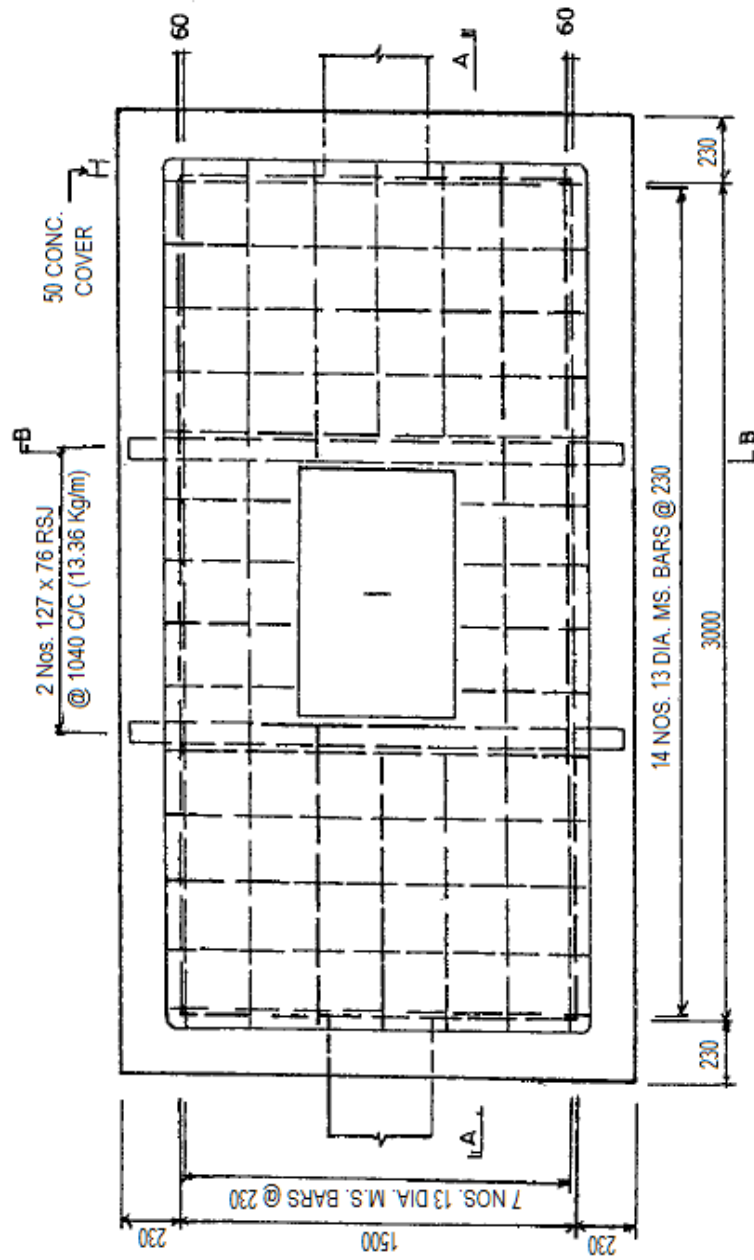

FIGURE 11.30: MANHOLE DRAWINGS - TYPE MX4



SECTION B-B
 (FRAME AND COVER OMITTED)
 SCALE : NTS

FIGURE 11.31: MANHOLE DRAWINGS - TYPE MX5 (DRAWING 1 OF 3)



PLAN SHOWING REINFORCEMENT OF TOP SLAB
(FRAME AND COVER OMITTED)
SCALE: NTS

FIGURE 11.32: MANHOLE DRAWINGS - TYPE MX5 (DRAWING 2 OF 3)

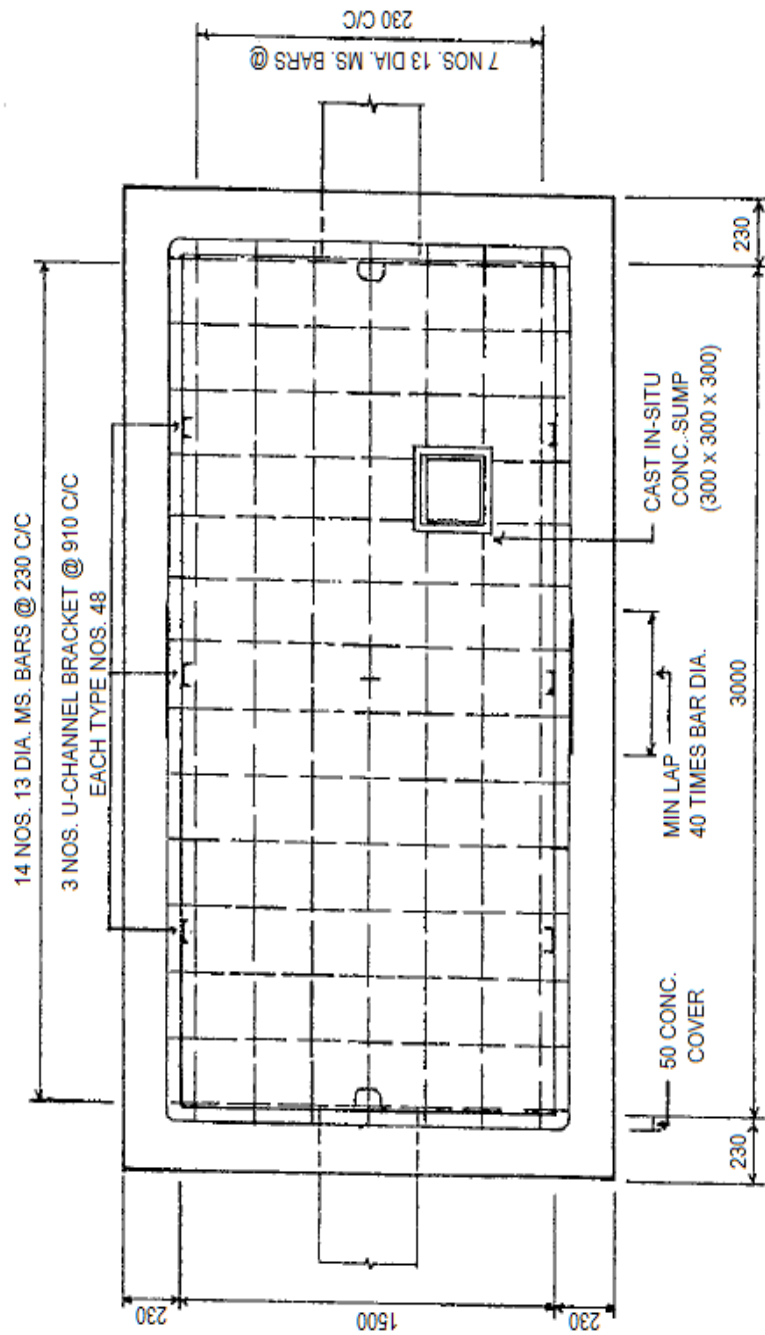

SECTIONAL PLAN SHOWING REINFORCEMENT OF BOTTOM SLAB

SCALE: NTS

FIGURE 11.34: DRAWINGS OF MULTI-WAY PIPELINES (CONT'D)

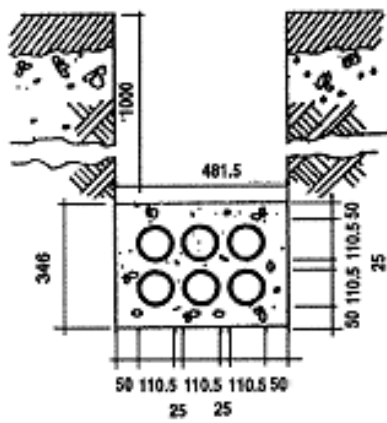

SECTION
6 way pipe formation
DRAWING NO 1d

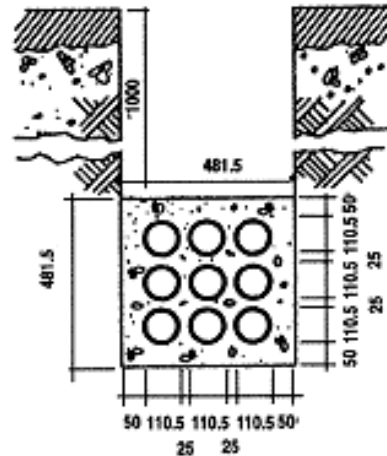

SECTION
9 way pipe formation
DRAWING NO 1e

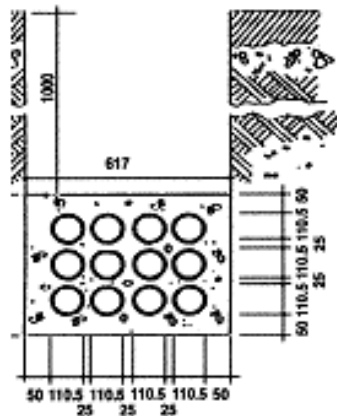

SECTION
12 Way pipe formation
DRAWING NO 1f

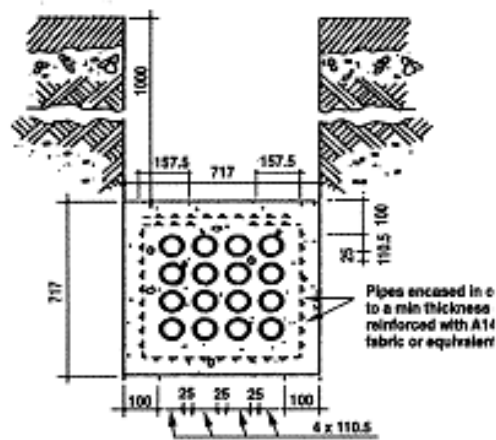

SECTION
16 Way pipe formation
DRAWING NO 1g

**FIGURE 11.34: DRAWINGS OF MULTI-WAY PIPELINES
(CONT'D)**

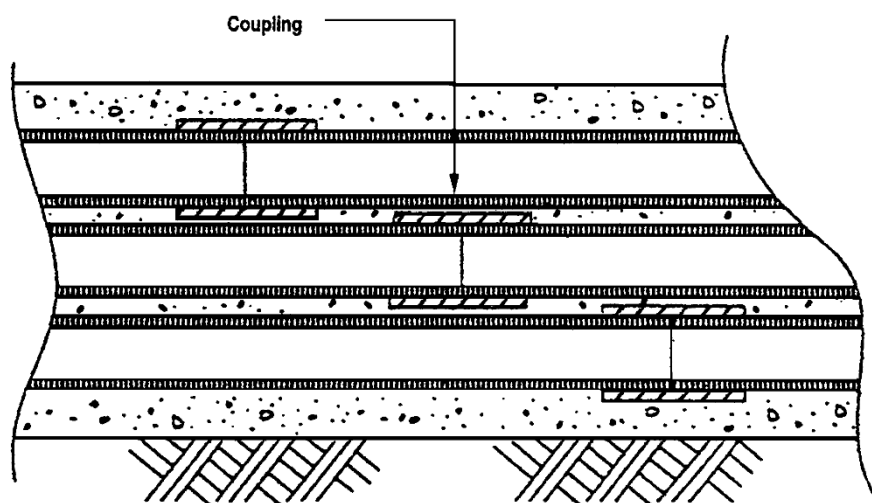

Detail showing staggered joints of
PVC applicable to all multiple ways

DRAWING NO 2

**FIGURE 11.34: DRAWINGS OF MULTI-WAY PIPELINES
(CONT'D)**

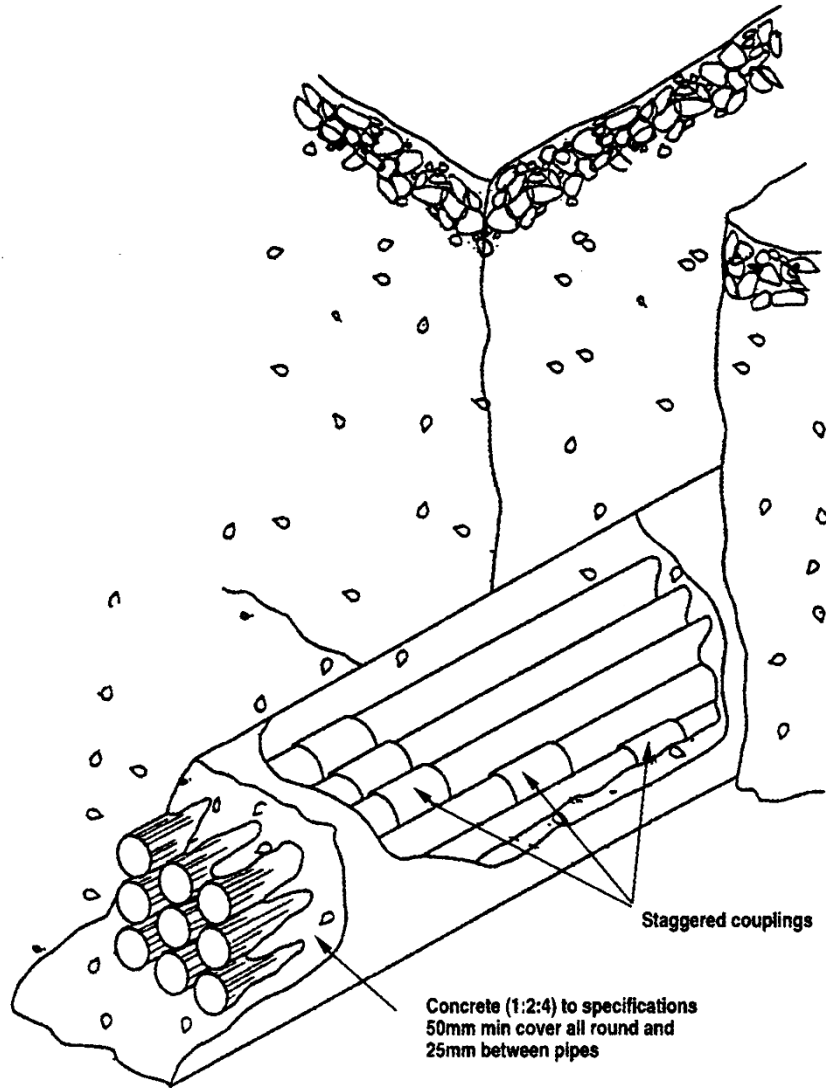

9 way pipe formation

DRAWING NO 3

**FIGURE 11.34: DRAWINGS OF MULTI-WAY PIPELINES
(CONT'D)**

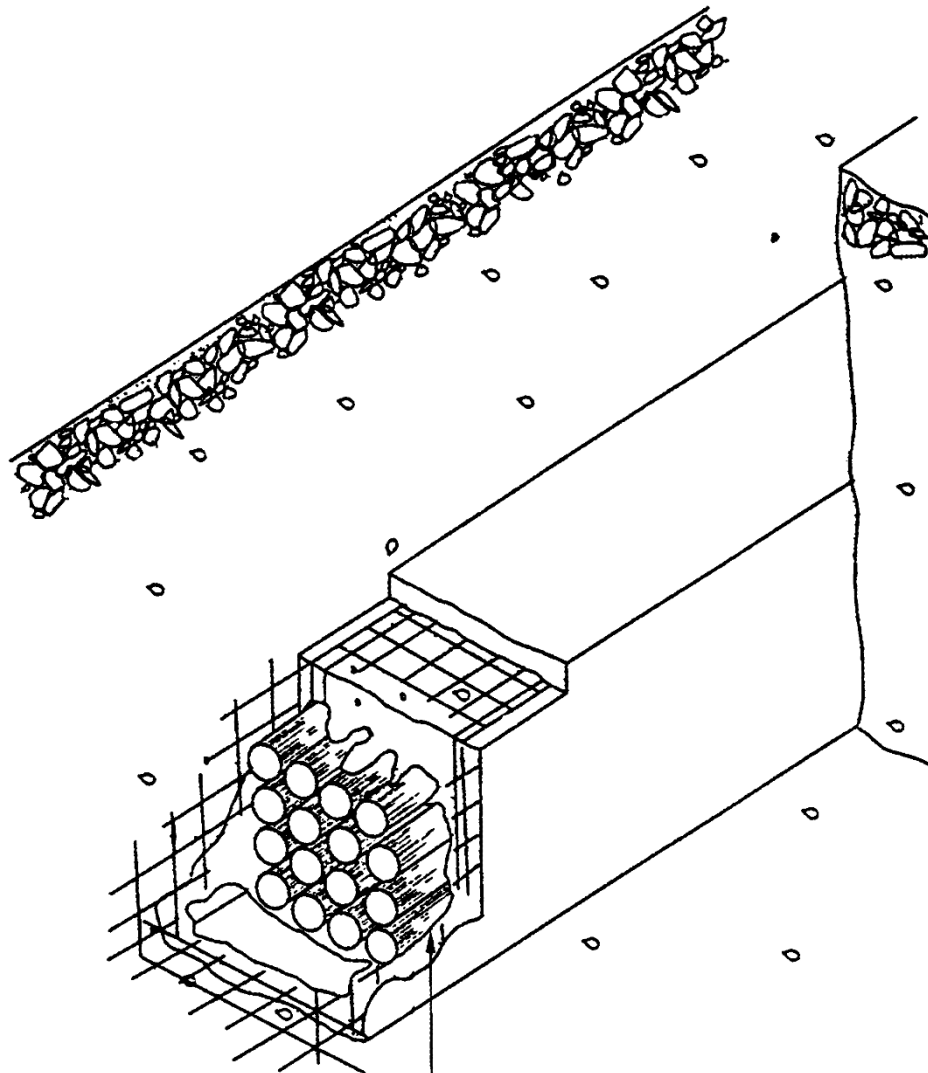

NOTES :

- 1) 16 Way pipe formation
- 2) All pipe formation exceeding 16 ways

Pipes encased in concrete (1:2:4) to a min thickness of 100mm reinforced with A142 steel fabric or equivalent

DRAWING NO 4

CHAPTER 12 SPECIFIC REQUIREMENTS FOR MAIN DISTRIBUTION FRAME ROOMS AND TELECOMMUNICATION EQUIPMENT ROOMS

12.1 Overview

- 12.1.1 This chapter sets out the specific requirements to be complied with by every developer or owner who is required to provide –
- (a) a main distribution frame room; and/or
 - (b) a telecommunication equipment room,
- under this Code.
- 12.1.2 IMDA reserves the right to require any developer or owner to provide main distribution frame rooms and/or telecommunication equipment rooms (notwithstanding that they are not required to be provided for the relevant development under this Code) or to require the quantities or sizes of such rooms to be increased beyond the requirements specified in this Code, to meet the demand for telecommunication services where necessary.

12.2 Location

- 12.2.1 Every developer or owner who is required to provide a main distribution frame room and/or telecommunication equipment room shall –
- (a) site the main distribution frame room and telecommunication equipment room as close as possible to the telecommunication risers;
 - (b) not site the main distribution frame room and telecommunication equipment room –
 - (i) in an area through which any system or network of water pipes, gas pipes or electrical trunking is running;
 - (ii) under any area that is susceptible to dampness or moisture such as a vehicle washing bay, swimming pool, washroom or toilet;
 - (iii) in any area which will subject the plant deployed therein to vibration of more than 0.05 G, where G is the acceleration due to gravity ($G=9.81 \text{ m/s}^2$); or
 - (iv) in any area where it will be directly subjected to the discharge of water, steam, fumes, gases or dust; and
 - (v) in any area within or near a bin centre.

12.3 Construction

- 12.3.1 Every developer or owner who is required to provide a main distribution frame room and/or telecommunication equipment room shall –

- (a) construct the room using reinforced concrete or brick wall;
- (b) finish the surface of the room with cement plaster and ensure that it is free of cracks, blisters or other defects;
- (c) paint the walls of the room with a light colour paint;
- (d) ensure that the room is of a minimum height of 3.5m (measured from the floor to the ceiling) throughout the entire room save that where it is not practicable to provide a minimum height of 3.5m, the developer or owner shall provide a cable ladder from the lead-in pipes which is to –
 - (i) run vertically to a height of at least 2.5m and subsequently run horizontally to all sides of the walls of the room with a height clearance of at least 300mm from any obstruction above it; and
 - (ii) have a width which is similar to the collective width of all the pipes entering the room;
- (e) finish the floor of the room with vinyl tiles or screed;
- (f) ensure that the concrete floor of the room is able to withstand a loading of 480kg/m²;
- (g) ensure that all doors of the room open outwards fully;
- (h) ensure that the door frames for the doors of the room have a 100mm high concrete skirting/kerb to prevent the ingress of water;
- (i) where the cable tray enters the room from the floor, ensure that the floor opening has a width that is not more than 1.25 times the width of the cable tray and a depth of not more than 200mm; and
- (j) where the cable tray enters the room from the floor, construct the floor opening with a kerb around the opening, extending vertically upwards and adjoining the opening, with a height of 100mm and a thickness of 50mm.

12.3.2 Where the developer or owner provides a main distribution frame room in the form of a standalone structure, such developer or owner shall, in addition to the requirements specified in paragraph 12.3.1, ensure that –

- (a) the floor of the main distribution frame room is at least 150mm above the immediate external final road or driveway level;
- (b) the floor of the main distribution frame room is waterproofed;
- (c) the walls of the main distribution frame room are waterproofed;
- (d) the emulsion painting system used for the outside wall of the main distribution frame room is suitable for external application;
- (e) the ceiling of the main distribution frame room is smoothly finished and emulsion painted;
- (f) the roof of the main distribution frame room is constructed of flat reinforced

concrete, suitably waterproofed and constructed to a fall of approximately 1:80 away from the direction of the door;

- (g) proper drainage is provided around the main distribution frame room such as hinged hot-dipped galvanised mild steel gratings;
- (h) where applicable, the gate and perimeter fencing is of a minimum height of 1.8m;
- (i) the driveway to the main distribution frame room is of a minimum width of 4m and designed to withstand a minimum vehicular load of a 3-tonne vehicle; and
- (j) all vacant space from the main distribution frame room to the perimeter fencing is paved using tarmac or weld-mesh reinforced concrete with fall designed for quick dispersion of water to the surrounding drains.

12.4 Ventilation and air-conditioning

12.4.1 Every developer or owner of a non-residential building who is required to provide a main distribution frame room shall provide for ventilation of the main distribution frame room by way of –

- (a) air-conditioning from the central system (where central air-conditioning system is provided in the relevant development), provided that the developer or owner shall –
 - (i) ensure that the temperature and relative humidity in the main distribution frame room is at ambient temperature; and
 - (ii) prior to the issuance of the Temporary Occupation Permit for the relevant building, seal all unused underground pipes at its point of entry into the main distribution frame room, with the Appropriate Sealing Material (as defined in paragraph 12.4.2); or
- (b) louvres on the wall above the door, along the whole of that side of the wall, of the main distribution frame room, and where it is necessary to further ventilate the room, the developer or owner shall install exhaust fans at the top corners of the main distribution frame room.

12.4.2 “Appropriate Sealing Material” means a material that is able to prevent foreign gaseous matter (which may be toxic or flammable) from passing through the underground pipes into the main distribution frame room and which shall be durable, easily removable to facilitate installation of cables, and not cause damage to the underground pipes or any telecommunication cables that may be installed therein.

12.4.3 Every developer or owner of a residential building who is required to provide a main distribution frame room and/or telecommunication equipment room shall –

- (a) provide louvres on the wall above the door, along the whole of that side of the wall, of the main distribution frame room and/or telecommunication equipment room; and

- (b) where it is necessary to further ventilate the room, install exhaust fans at the top corners of the main distribution frame room and/or telecommunication equipment room.

12.5 Electrical

12.5.1 Every developer or owner who is required to provide a main distribution frame room and/or telecommunication equipment room shall –

- (a) provide electrical mains to the main distribution frame room and/or telecommunication equipment room from the main electrical distribution panels which shall be successfully tested by qualified persons licensed or certified by the competent authority or electricity company; and
- (b) ensure that the mean lighting illuminance in the main distribution frame room and/or telecommunication equipment room is at least 450 lux at floor level.

12.6 Earthing

12.6.1 Every developer or owner who is required to provide a main distribution frame room and/or telecommunication equipment room shall –

- (a) ensure that the earthing point is connected to the earth electrode system via earth cable with a cross section area of not less than 50mm²;
- (b) ensure that the copper earth bar has screw holes that are spaced 50mm apart measured from centre to centre; and
- (c) place the certified test result of the earth system together with actual layout diagrams showing the earth system arrangement in the main distribution frame room and/or telecommunication equipment room.

CHAPTER 13 SPECIFIC REQUIREMENTS FOR TELECOMMUNICATION RISERS

13.1 Overview

13.1.1 This chapter sets out the specific requirements to be complied with by every developer or owner who is required to provide telecommunication risers under this Code.

13.2 General requirements

13.2.1 Every developer or owner who is required to provide telecommunication risers shall –

- (a) not site the telecommunication risers in any area within or near a bin centre;
- (b) provide a single-leaf door (the width of which shall be in accordance with the requirements set out in the relevant chapters in this Code) that can be opened fully outwards and is approximately 2.1m in height, on the width side of each telecommunication riser on every floor;
- (c) if the width of the riser exceeds 1.1m, provide a double-leaf door (the width of which shall be in accordance with the requirements set out in the relevant chapters in this Code) that can be opened fully outwards and is approximately 2.1m in height, on the width side of each telecommunication riser on every floor;
- (d) ensure that the fire-rating of the doors and compartment walls of the telecommunication risers complies with the requirements of the relevant authorities;
- (e) provide a 100mm high concrete skirting or kerb behind the doors of the telecommunication risers;
- (f) ensure that a label with the words “Telecoms Riser” with appropriate numbering for identification purpose is affixed to the door of the telecommunication riser on every floor;
- (g) provide adequate lighting to enable licensees to carry out their installation and maintenance work in the telecommunication risers;
- (h) ensure that the dimensions of the inter-floor openings in the telecommunication risers are as follows (and as shown in Figure 13.4) –
 - (i) the width of the inter-floor opening shall be equivalent to 1.25 times the width of the cable trays; and
 - (ii) the depth shall be between 180mm to 220mm;
- (i) ensure that the inter-floor openings for the telecommunication risers are sealed with fire resistant material (as shown in Figure 13.4), which can be easily removed, in compliance with the Code of Practice for Fire Precautions in Buildings issued by Singapore Civil Defence Force (the

“Sealing Obligation”) no earlier than 1 month prior to the expected date of issuance of the Temporary Occupation Permit (the “Due Date”), regardless of whether the licensees have completed the installation of their cables by the Due Date. For the avoidance of doubt, licensees who install their cables after the developer or owner has completed the sealing of inter-floor openings, will have to remove the seal and re-seal the inter-floor openings at their own cost;

- (j) ensure that the concrete floor in the telecommunication riser (as shown in Figure 13.4) is able to withstand the same loading as the floor outside the riser;
- (k) ensure that the walls of the telecommunication risers are smoothly plastered and painted with a light colour;
- (l) where telecommunication cables are laid from the individual units in the building to the telecommunication risers, ensure that such cables are terminated at the appropriate termination, distribution boxes, fibre interface points or tube patch panels located in the telecommunication risers; and
- (m) ensure that the internal wiring to all units is only performed by licensed telecommunication internal wiring contractors.

13.3 Internal wiring schedule

13.3.1 Every developer or owner who provides internal wiring shall –

- (a) prominently display an internal wiring schedule in the main distribution frame room indicating the unit numbers of the units to be served by the applicable telecommunication riser;
- (b) ensure that the internal wiring schedule is in the format shown in Table 13.3.1 below; and

Table 13.3.1 Internal wiring schedule

Telecom riser number	Address of unit served

- (c) extend a copy of the internal wiring schedule to licensees upon their request.

13.4 Placement of cables in telecommunication riser

Every developer or owner who is required to provide telecommunication risers shall ensure that the cables and associated cabling facilities for telecommunication are placed on opposite side walls of the telecommunication riser as shown in Figure 13.4 below.

FIGURE 13.4: TYPICAL LAYOUT IN TELECOMMUNICATION RISER

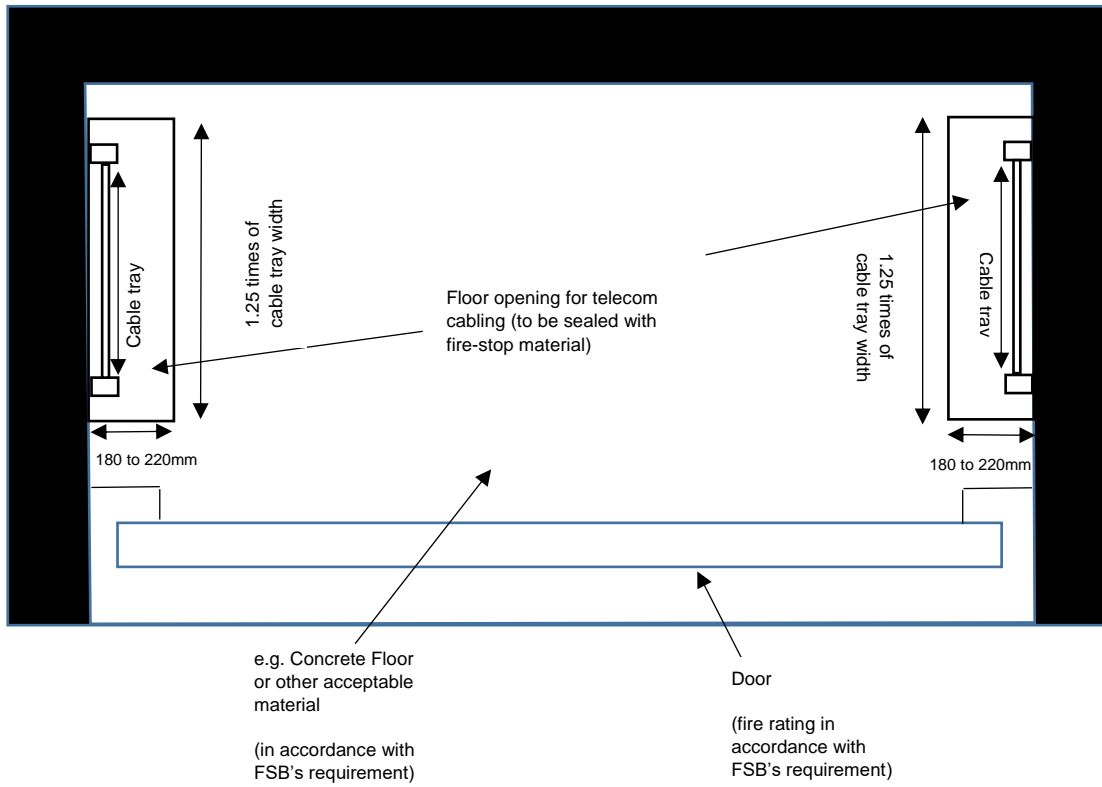

SCALE: NTS

CHAPTER 14 SPECIFIC REQUIREMENTS FOR COAXIAL CABLES

14.1 General

14.1.1 This chapter sets out the specific requirements to be complied with by every developer or owner who is required to provide coaxial cables for TV under this Code.

14.2 Installation of coaxial cables from the utility room or closet to every living room(s) and bedroom(s) of each residential unit

14.2.1 Every residential unit shall be provided, at the minimum, with –

- (a) RG6 coaxial cable(s) of a number equal to the total number of living room(s) and bedroom(s), which shall terminate into the output of a multi-way splitter (which may be located in the utility room or closet) at one end and into an F-type TV outlet in each of the living room(s) and bedroom(s) at the other end; and
- (b) 1 RG6 coaxial cable, which shall terminate into the input of the splitter (which may be located in the utility room or closet) at one end, and into an IEC 61169-2 coaxial connector in the living room at the other end, to enable the installation of an indoor antenna.

14.3 Coaxial cable specifications for installation in conduits or surface trunking

14.3.1 The coaxial cable used shall meet or exceed the minimum requirements stated below –

- (a) characteristic impedance: $75\Omega \pm 2\Omega$;
- (b) velocity of propagation: more than 85%;
- (c) structural return loss: exceed 20dB (47-824 MHz);
- (d) the centre conductor shall be copper-clad steel, Beryllium copper alloy or hard drawn copper, and shall have a solid single core and be compliant with the specifications of the SCTE for broadband coaxial cable systems;
- (e) the dielectric shall be gas expanded foam polyethylene;
- (f) the shielding shall consist of an aluminium-polypropylene-aluminium (or equivalent) laminated tape longitudinally wrapped with an overlap around the dielectric and shall be bonded to the dielectric with a layer of adhesive to provide 100% coverage and long-term reliability of shielding performance;
- (g) the outer jacket shall be polyvinyl chloride (PVC) for dry environment and polyethylene (PE) for damp environment;
- (h) the screening effectiveness shall be either –

- (i) greater than 90dB at 200MHz when measured using the Dipole Antennae Procedure (see NCTA Recommended Practices for Measurements on Cable TV Systems, 2nd Edition, Part 1, Section J), or
 - (ii) greater than 80dB at 200MHz when measured using the Absorbing Clamp method (see pr EN 50083-2:1992);
- (i) the cables used shall be able to withstand long term operation in high humidity environments without deterioration; and
 - (j) suitable centre conductor with corrosion prevention should preferably be incorporated to reduce corrosion or oxidation of the centre conductor's copper surface.

14.4 Installation of multi-ways splitter

14.4.1 The multi-ways splitter used shall meet or exceed the minimum requirements stated below –

- (a) the screening effectiveness shall be greater than 80dB; and
- (b) the return loss over the total frequency band shall be better than 12dB.

14.5 Installation of TV outlets

14.5.1 The TV outlets used shall be F-type, with long (12mm – 19mm) attached ferrule.

14.6 Safety requirements

14.6.1 The RG6 coaxial cables shall be installed so as to present no hazard or danger, either in normal use or under fault conditions, to end users and personnel working on or inspecting such cables, including providing for –

- (a) personal protection against electric shock;
- (b) personal protection against physical injury; and
- (c) protection against fire.

14.6.2 The splitter should also be fitted with bonding terminals complying with the relevant paragraphs of IEC 60065:2001.

CHAPTER 15 SPECIFIC REQUIREMENTS FOR OPTICAL FIBRE CABLES PROVIDED IN RESIDENTIAL DEVELOPMENTS AND 2-WAY AIR-BLOWN FIBRE MICRODUCTS PROVIDED IN NON-RESIDENTIAL DEVELOPMENTS

15.1 General

15.1.1 This chapter sets out the specific requirements to be complied with by every developer or owner who is required to provide –

- (a) optical fibre cables in residential developments; and/or
- (b) 2-way air-blown fibre microducts in non-residential developments,

under this Code.

15.2 Installation of optical fibre cable from telecommunication riser or gate pillar (or meter compartment) to each residential unit

15.2.1 A minimum of 1 4-core optical fibre cable shall be installed in the conduit or underground pipe, as specified in the relevant chapters of this Code.

15.2.2 The 4-core optical fibre cable shall be terminated, with an additional 2m length as “slack”, at each end into –

- (a) a fibre termination point which is located in the telecommunication riser or gate pillar (or meter compartment); and
- (b) a fibre termination point which is located in the residential unit.

The fibre termination point in (a) and (b) shall each be a set of 4 SC/APC connectors.

15.2.3 Where the fibre termination point is located in the telecommunication riser, the other fibre termination point shall be located on the same floor as the residential unit.

15.2.4 The fibre termination points should be clearly labelled, indicating the corresponding residential unit where the 4-core optical fibre cable is installed.

15.3 Optical fibre cable specifications for installation in conduits to each residential unit

15.3.1 The optical fibre cable that is installed in conduits to each residential unit shall meet or exceed the minimum requirements stated below –

- (a) comply with the G.657 Category A specifications in the ITU-T Recommendations;
- (b) comprise an outer sheath of fire retardant polyethylene or Low Smoke Free of Halogen (LSFH) material;
- (c) have a central strength member that is made of Aramid Yarn (Kevlar Yarn) or its equivalent; and

- (d) be able to withstand a maximum tensile load of at least 500N.

15.4 Optical fibre cable specifications for installation in underground pipe to each residential unit

15.4.1 The optical fibre cable that is installed in underground pipes to each residential unit used shall meet or exceed the minimum requirements stated below –

- (a) comply with the specifications in sub-category G.652.D in the ITU-T Recommendations;
- (b) have a loose tube with filled jelly compound and polyethylene sheath;
- (c) have a central strength member that is made of Aramid Yarn (Kevlar Yarn) or its equivalent; and
- (d) use water blocking tape to enhance prevention of water armouring.

15.5 Fibre termination point for telecommunication riser/gate pillar

15.5.1 The fibre termination point shall be securely mounted at the width of the telecommunication riser, i.e. wall that is facing the door.

15.5.2 Where there is no telecommunication riser, the fibre termination point shall be securely mounted inside the gate pillar (or meter compartment) at a height which is at least 1m.

15.5.3 The fibre termination point shall have 4 SC/APC connectors.

15.6 Fibre termination point in each residential unit

15.6.1 The fibre termination point shall have 4 SC/APC connectors.

15.6.2 The fibre termination point shall –

- (a) be securely mounted adjacent to the RJ45 patch panel (which may be located in the utility room or closet) and 13A switch socket outlet; and
- (b) have a clear space of 50mm from the SC/APC connectors to allow the connection of patch cords.

15.7 Safety requirements for installation of optical fibre cables

15.7.1 The optical fibre cables shall be installed so as to present no hazard or danger, either in normal usage or under fault conditions, to end users and personnel working on or inspecting such cables, including providing for –

- (a) personal protection against electric shock;
- (b) personal protection against physical injury; and

- (c) protection against fire.

15.7.2 The following precautions shall be taken into consideration while handling or working with any optical fibre cable –

- (a) keep all food and beverages out of the work area as ingesting optical fibre particles may cause internal haemorrhage;
- (b) work on a black work surface for better visibility of optical fibre scraps;
- (c) wear disposable aprons to prevent optical fibre particles from coming into contact with clothing;
- (d) always wear safety glasses with side shields and protective gloves;
- (e) never look directly into the end of fibre optic cables unless necessary. If there is a need to look into the end of the fibre optical fibre, confirm that there is no light source at the other end. Use a fibre optic power meter to make certain the fibre optical cable is dark. When using an optical tracer or continuity checker, look at the fibre from an angle at least 6 inches away from the eyes to determine if visible light is present;
- (f) all work areas must be well ventilated;
- (g) contact lens wearers must not handle their lenses until they have thoroughly washed their hands;
- (h) do not touch the eyes with hands while working with optical fibre cables until the hands have been thoroughly washed;
- (i) all cut optical fibre pieces must be placed in a properly marked container for disposal;
- (j) all work areas must be thoroughly cleaned upon the completion of work; and
- (k) no smoking while working with optical fibre cables.

15.8 Testing criteria for the optical fibre cable from the telecommunication riser or gate pillar (or meter compartment) to each residential unit

15.8.1 To ensure that the optical fibre cable is in good working condition upon completion of installation works, both of the following methods of testing must be carried out –

- (a) Continuity testing – This involves checking that the optical fibre cable is not physically broken at any point, and that the optical fibre cable does indeed go from one location to the correct destination using a powerful visible red laser; and
- (b) Scanning at the fibre interface/termination point with an Optical Time Domain Reflectometer (“OTDR”) – An OTDR is capable of measuring the fibre lengths, losses, connector losses, splice losses and fibre defects, and works by sending a pulse of light into the fibre and measuring how much light is reflected back and detected at the OTDR. It will produce a line or graph on a screen and by measuring how much light is reflected, the OTDR can determine the loss

associated with each of these anomalies. The optical fibre cable will be treated as being in good working condition if the losses measured between the fibre interface point at the telecommunication riser or the gate pillar (or meter compartment) and the fibre termination point at the residential unit using the OTDR are less than 0.6dB.

15.9 Fibre Readiness Certification

- 15.9.1 Prior to obtaining issuance of the Temporary Occupation Permit by the relevant authority, the developer or owner shall obtain fibre readiness certification for the development from an operator licensed to provide passive optical fibre connectivity service.
- 15.9.2 The requirement for Fibre Readiness Certification is applicable to all new residential developments, with the exception of a development consisting of only 1 single landed dwelling-house.
- 15.9.3 There should not be any significant wiring changes after the optical fibre cable and its associated fibre interface and termination points have been certified “fibre-ready”.

15.10 2-way air-blown fibre microducts to non-residential unit

- 15.10.1 The 2-way air-blown fibre microducts used shall meet or exceed the minimum requirements stated below –
 - (a) be marked with –
 - (i) manufacturer’s name; and
 - (ii) year of manufacturing;
 - (b) comprise an outer sheath of fire retardant polyethylene complying with IEC 60332-1 or Low Smoke Zero Halogen material;
 - (c) be able to withstand a pressure of 15 bar with an end cap installed at 1 end of the air-blown fibre microduct; and
 - (d) provide labels to the both ends of the microducts, e.g. #05-08, in the non-residential unit and in the telecommunication riser.

15.11 Tube patch panel for 2-way air-blown fibre microducts

- 15.11.1 A tube patch panel with bulkhead connectors (5mm) shall be installed in the telecommunication riser for the termination of 2-way air-blown fibre microducts. The tube patch panel shall be located at a height of 1.5m (from floor finish) and placed on the width of the telecommunication riser. The tube patch panel shall come with a supporting bracket to allow a turning radius of 100mm or 20 times the diameter of the 2-way air-blown fibre microducts.

15.12 End caps for 2-way air-blown fibre microducts

15.12.1 End caps shall be installed for the air-blown fibre microducts to prevent mud, dirt and moisture from entering the air-blown fibre microducts. The end caps shall be installed at the open ends of the air-blown fibre microducts installed in every non-residential units and shall meet or exceed the minimum requirements stated below –

- (a) be able to cap the air-blown fibre microducts of (5/3.5)mm; and
- (b) be able to withstand a pressure of 15 bar with an end cap installed at 1 end of the air-blown fibre microduct.

CHAPTER 16 OBLIGATIONS OF LICENSEES IN RELATION TO THE USE OF, AND ACCESS TO, SPACE AND FACILITIES

16.1 Application of this chapter

- 16.1.1 This chapter specifies the requirements to be observed by every licensee that deploys its installation, plant or system within the space and facilities of any development provided pursuant to this Code or any previous codes.
- 16.1.2 For the purposes of this chapter, where a licensee connects its pipes to the lead-in pipes of a development, such connection shall be regarded as a deployment of plant by such licensee.

16.2 Eligibility to use

- 16.2.1 Only licensees who –
- (a) provide telecommunication services via fixed-line method or fixed-wireless method may deploy their installation, plant or system in the relevant space and facilities (save for the mobile deployment space) of a development; and
 - (b) provide public cellular mobile telecommunication services may deploy their installation, plant or system in the relevant space and facilities (save for the main distribution frame room and the telecommunication equipment room) of a development.

16.3 Access to relevant space and facilities

- 16.3.1 Every licensee who wishes to access a development for the purpose of deploying its installation, plant or system in the relevant space and facilities of that development shall give notice to the developer or owner stating –
- (a) as fully and accurately as possible the nature and extent of the acts intended to be done; and
 - (b) a reasonable timeframe (which shall in any case be no less than 14 days) for the developer or owner to raise its objection (if any) to the licensee's intended use of the space and facilities.
- 16.3.2 Every licensee who wishes to access the relevant space and facilities of any development for the purpose of conducting site surveys and associated preparatory work, inspecting, maintaining, repairing or upgrading any installation, plant or system which it has deployed in such space and facilities shall give reasonable notice to the developer or owner to obtain grant of access.
- 16.3.3 Where a developer or owner objects to the licensee's intended use of the relevant space and facilities as notified by the licensee under paragraphs 16.3.1 and 16.3.2, both parties shall co-operate in good faith to resolve the matter in a timely manner. In the event that parties are unable to reach agreement, they may refer the matter to IMDA for a decision which shall be binding on the parties.

- 16.3.4 Where a licensee requires Emergency Access (to the relevant space and facilities, the licensee shall give notice to the developer or owner to request for Emergency Access, which shall be granted by the developer or owner in accordance with the timeframes specified in paragraph 2.5.4. "Emergency Access" refers to the access required by a licensee for any of the following purposes –
- (a) to carry out urgent works to restore its services due to unforeseen and unscheduled outages, disruptions or downtime, which cannot be resolved by the licensee remotely; or
 - (b) to take any action in relation to its installation, plant or systems deployed within the relevant space and facilities in order to comply with any applicable laws, regulatory requirements or lawful orders issued by any competent authority to the licensee.

For the avoidance of doubt, the foregoing shall not in any way limit or affect the developer's or owner's obligation to comply with any applicable laws, regulatory requirements or lawful orders issued by any competent authority to the developer or owner in connection with the relevant space and facilities, and access thereto.

- 16.3.5 The licensee shall bear any reasonable cost and expense incurred by the developer or owner in providing Emergency Access to the licensee (e.g. engagement of security escort for unmanned buildings).
- 16.3.6 Every licensee that has deployed its installation, plant or systems within a development shall obtain from the developer or owner the contact details of a duly authorised person(s) whom the licensee may contact at all times for the grant of Emergency Access to the development and shall keep such contact details updated. Licensees shall also provide the developer or owner with the contact details of their authorised personnel with whom the developer or owner may liaise with for the purposes of Emergency Access.
- 16.3.7 For the avoidance of doubt, nothing in paragraph 16.3.4 above shall exempt or relieve a licensee of any regulatory obligations relating to the availability and quality of its services, including any obligations pertaining to the resiliency of its networks.
- 16.3.8 Where the relevant space and facilities are located at a height of more than 4m above floor level, the licensee shall be responsible for procuring and implementing the appropriate means of access (e.g. boom lifts, scaffolding, etc) to such space and facilities at its own cost and expense. For the avoidance of doubt, this paragraph does not exempt the licensee from complying with any applicable obligations under the prevailing statutory or regulatory requirements pertaining to workplace safety and health.

16.4 Use of relevant space and facilities

- 16.4.1 Where the licensee requires an agreement to be put in place with a developer or owner in connection with the licensee's use of, and access to, the relevant space and facilities in the development, the licensee shall ensure that the terms and conditions of such agreement do not derogate from, and are not inconsistent with, the obligations imposed on the licensee under this Code.
- 16.4.2 Every licensee who accesses, uses and deploys its installation, plant or system in the relevant space and facilities of any development shall at all times –

- (a) exercise the reasonable skill and care of a competent telecommunications operator;
- (b) take such action as may be necessary to render such installation, plant or system safe and secure;
- (c) abide by any reasonable house rules imposed by the developer or owner;
- (d) ensure that it deploys its installation, plant or system in the most efficient manner possible;
- (e) only deploy such installation, plant or system as is reasonably necessary under all the circumstances;
- (f) not deploy its installation, plant or system in a manner which unreasonably prevents any other licensee who wishes to deploy its installation, plant or system within the same space and facilities from doing so;
- (g) co-operate in good faith with any other licensee who wishes to deploy its installation, plant or system within the same space and facilities to enable such licensee to carry out its deployment in an expedient manner;
- (h) not make any structural alteration to the relevant space and facilities without the approval of the developer or owner;
- (i) take due care to maintain the tidiness, cleanliness and condition of the relevant space and facilities in which it deploys its installation, plant or system, and those parts of the land which it accesses in connection with such deployment;
- (j) where it causes any damage to the relevant space and facilities in which it deploys its installation, plant or system, or to those parts of the land which it accesses in connection with such deployment, inform the developer or owner and make good the damage caused;
- (k) indemnify and hold harmless the developer or owner from and against all claims, actions, liabilities, damages or losses which arise out of or relate to its use of, and access to, the relevant space and facilities;
- (l) when carrying out any activities in connection with its deployment of installation, plant or system in the relevant space and facilities, take reasonable steps to minimise the disturbance and inconvenience caused to the occupants of the building and comply with all requirements imposed by the relevant authorities including any limits on noise levels and safety;
- (m) subject to paragraphs 16.4.4 to 16.4.7, pay for all utility charges incurred for the operation of the installation, plant or system deployed in the relevant space and facilities unless otherwise agreed with the developer or owner;
- (n) where it is necessary to drill or core through any concrete floor or wall of a building for the deployment of its installation, plant or system, consult and obtain the written approval of the developer or owner for such drilling or coring works, and carry out the drilling or coring works at its own cost and expense;
- (o) where it is necessary to deploy any additional cable distribution system in the

development, consult the developer or owner on the routing of the system, and deploy the system in a manner that is neat and tidy, and as far as reasonably practicable, minimises the footprint of such system;

- (p) where it is necessary to remove and replace the fire resistant material used to seal the inter-floor openings for the telecommunication risers for the purposes of deploying its installation, plant or system, carry out such removal and replacement at its own cost and expense;
- (q) where it ceases to provide any service to a development, remove, within a reasonable timeframe, any installation, plant or system deployed in the relevant space and facilities which is no longer required at its own cost and expense; and
- (r) where an occupier of a unit within a development terminates his subscription for a telecommunication service that is delivered via fibre using the 2-way air-blown fibre microduct installed to that unit pursuant to this Code, the licensee providing the terminated telecommunication service shall remove the fibre that it has installed in the microduct, at its own cost and expense, within 7 days from being notified by any other licensee who requires use of the microduct to provide telecommunication services to the occupier of the unit.

16.4.3 For the purposes of paragraph 16.4.2 –

- (a) where the licensee engages any agent, supplier or contractor (including any independent contractor) to carry out any works or to supply any installation, plant or system in relation to the licensee's use of the relevant space and facilities, the licensee shall remain solely responsible for complying with all the requirements stated in paragraph 16.4.2; and
- (b) all references to the act of deployment of any installation, plant or system shall include the act of conducting sites surveys and associated preparatory work, inspecting, maintaining, repairing or upgrading such installation, plant or system.

16.4.4 Where the developer or owner has served a notice requiring any licensee to bear utility charges for the operation of any installation, plant or system deployed by the licensee in the relevant space and facilities, the licensee shall bear the utility charges on a prospective basis commencing one (1) month from the date of service of such notice.

16.4.5 Where the notice specified in paragraph 16.4.4 is served on the licensee, the licensee and the developer or owner shall reach an agreement on the basis upon which to compute the utility charges to be borne by the licensee. Where the licensee and the developer or owner are unable to agree on such basis, the utility charges to be borne by the licensee shall be based on the estimated power consumption of the licensee's installation, plant or system.

16.4.6 Notwithstanding paragraph 16.4.5, where it is physically feasible, the licensee may, at its own cost, install the necessary electrical installations (including cables, a separate utility meter and any other accessory) to enable the utility charges to be computed on an "as incurred" basis and paid directly to the utility provider.

16.4.7 For the avoidance of doubt, the licensee shall not be required to bear any utility charges incurred prior to the commencement date referred to in paragraph 16.4.4.

16.5 Additional obligations in relation to mobile deployment space

- 16.5.1 Every mobile telecommunication licensee shall comply with the obligations specified in this paragraph 16.5, in addition to all other obligations specified in this chapter.
- 16.5.2 In determining the location of the mobile deployment space to be provided by a developer or owner, the mobile telecommunication licensee shall observe the following –
- (a) where feasible, the mobile deployment space shall be located on the rooftops of buildings to optimise the coverage of the installation, plant or systems to be deployed by the mobile telecommunication licensee;
 - (b) there shall be adequate access and work space provided around equipment sited in the mobile deployment space to reasonably enable the mobile telecommunication licensee to carry out any requisite works in relation to the installation, plant or systems deployed therein;
 - (c) the mobile deployment space may be split into one (1) or more locations within the development so as to facilitate the provision of public cellular mobile telecommunication services to the whole development, provided that the total amount of mobile deployment space at all locations combined shall not exceed the maximum amounts to be provided by the developer or owner as specified in this Code;
 - (d) the mobile deployment space shall be located at unused spaces within the development;
 - (e) the mobile deployment space shall not be located in the main distribution frame room or the telecommunication equipment room, unless there is sufficient space available after having fulfilled the space requirements of the main distribution frame room or telecommunication equipment room and there is a clear demarcation of the space designated as mobile deployment space; and
 - (f) the mobile deployment space shall not be located in any area that –
 - (i) is susceptible to the risk of flooding;
 - (ii) is directly subject to the discharge of water, steam, fumes, gases or dust;
 - (iii) is within or near a bin centre; and
 - (iv) is not able to withstand a loading of 1.5kN/m² or more and for tunnels a loading of 7.5kN/m² or more; and
 - (v) will subject the installation, plant or systems deployed therein to vibration of more than 0.05 G, where G is the acceleration due to gravity (G=9.81 m/s²).
- 16.5.3 Where the mobile telecommunication licensee is responsible for complying with any statutory or regulatory requirements or obtaining any requisite approvals for its use of the mobile deployment space, the licensee shall do so at its own cost and expense.

16.5.4 Where the mobile telecommunication licensee requires lighting and ventilation to be provided at a mobile deployment space to enable the mobile telecommunication licensee to deploy and operate its installation, plant or system at that location, the mobile telecommunication licensee shall bear the cost and expense for the provision of the necessary lighting and ventilation.

16.5.5 Where the mobile telecommunication licensee requires –

(c) facilities (e.g. cable distribution system and power distribution system) to be installed to serve its installation, plant or system deployed at the mobile deployment space; or

(d) works to be carried out in connection with the installation of such facilities and use of the mobile deployment space (e.g. drilling and coring works, and the opening and reinstatement of false ceilings and access panels),

the mobile telecommunication licensee shall bear the cost and expense for the installation of the necessary facilities and the carrying out of the necessary works.

16.5.6 Where the developer or owner requires the mobile telecommunication licensee to remove its installation, plant or system deployed at the mobile deployment space due to the need to demolish the building, the mobile telecommunication licensee shall bear its own costs and expenses for such removal.

16.6 Sealing of underground pipes leading into an air-conditioned or unventilated main distribution frame room or telecommunication equipment room

16.6.1 Where a licensee deploys its telecommunication cables into any underground pipe leading into –

(a) any main distribution frame room or telecommunication equipment room that is air-conditioned; or

(b) any main distribution frame room or telecommunication equipment room that is not air-conditioned and which has no free-flowing ventilation (such as a room with no louvres or exhaust fans or equivalent means of ventilation),

(collectively referred to in this paragraph 16.6 as an “Enclosed Room”)

the licensee shall ensure that it seals the relevant underground pipe at its point of entry into such Enclosed Rooms with the Appropriate Sealing Material (as defined in paragraph 16.6.2).

16.6.2 “Appropriate Sealing Material” means a material that is able to prevent foreign gaseous matter (which may be toxic or flammable) from passing through the underground pipes into the Enclosed Room and which shall be durable, easily removable to facilitate installation of cables, and not cause damage to the underground pipes or any telecommunication cables that may be installed therein.

16.6.3 Where the underground pipes are already sealed prior to the licensee deploying its telecommunication cables, the licensee shall be responsible for removing the existing seal and re-sealing the pipes upon completion of its cable installation work.

16.7 Deployment of installation, plant or system

- 16.7.1 Where a licensee (the “Existing Licensee”) has deployed its installation, plant or system in a manner which does not efficiently optimise the use of the relevant space and facilities (save for mobile deployment space), the Existing Licensee shall co-operate in good faith with any other licensee (the “Requesting Licensee”) who wishes to deploy its installation, plant or system within the same space and facilities to –
- (a) rearrange, remove or alter, at the Existing Licensee’s own expense, such installation, plant or system or any part thereof; and
 - (b) perform any such rearrangement, removal or alteration within a reasonable timeframe to facilitate deployment by the Requesting Licensee.
- 16.7.2 In the event that the licensees are unable to reach agreement on the rearrangement, removal or alteration that should be effected, they may refer the matter to IMDA for a decision which shall be binding on the licensees.
- 16.7.3 All mobile telecommunication licensees shall share the mobile deployment space provided within any development (without road and train tunnels) on an equal basis, unless otherwise agreed between the licensees. For example, where a mobile telecommunication licensee (the “Earlier MTL”) has already occupied all or a substantial part of the maximum amount of mobile deployment space provided for a development and other mobile telecommunication licensees (the “Later MTLs”) subsequently desire to use that same mobile deployment space, the Earlier MTL shall remove, alter or relocate its installation, plant or system, as may be necessary, to enable the Later MTLs to share the mobile deployment space equally. Where any mobile telecommunication licensee is required to remove, alter or relocate its installation, plant or system to accommodate equal sharing of the mobile deployment space with other mobile telecommunication licensees, that licensee shall do so within a reasonable timeframe and at its own cost and expense.
- 16.7.4 For developments with 1 or more road and train tunnel(s), each mobile telecommunication licensee shall co-operate in good faith to reach agreement with all the other mobile telecommunication licensees as to the allocation of the mobile deployment space that is provided by the developer or owner under chapter 10.

16.8 Connections to lead-in pipes

- 16.8.1 Every licensee that connects its pipes to the lead-in pipes of a development shall only make such number of connections as are necessary to meet the demand for its services.
- 16.8.2 Subject to any reference or standard interconnection offer or infrastructure sharing agreements (as mandated and approved by IMDA) that licensees have entered into which shall take precedence, where a licensee has connected its pipes to the lead-in pipes of any development but is not using any of its pipes (“Unused Pipe”) or is using less than 50% of the space in any of its pipes (“Partially Used Pipe”), and the Requesting Licensee requires the use of the licensee’s Unused Pipe or the space in the licensee’s Partially Used Pipe, that licensee shall allow the Requesting Licensee to use the licensee’s Unused Pipe or the space in the licensee’s Partially Used Pipe, including the use of the associated lead-in manholes, at cost-based prices.

- 16.8.3 Every licensee that connects its pipes to the lead-in pipes of a development shall –
- (a) ensure that the pipes and the associated lead-in manholes which it connects to the lead-in pipes are grouped together and not placed in a manner which obstructs any other licensee from connecting its own pipes to the lead-in pipes; and
 - (b) connect its pipes to the lead-in pipes in a left-to-right or right-to-left method (depending on where the previous connection has been made) or in a bottom-up manner as illustrated in Figure 16.8.3.

Figure 16.8.3 Method in which licensees are to connect to lead-in pipes

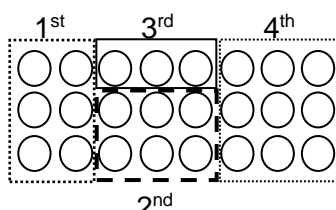

- 16.8.4 IMDA may require any licensee who fails to comply with paragraph 16.8.3 to remove or re-position its connections to the lead-in pipes or to remove or re-position its manholes at its own expense.
- 16.8.5 Every licensee who deploys multiple telecommunication cables to the same development shall, where practicable, install sub-ducts or their equivalent in the lead-in pipes such that each lead-in pipe is able to accommodate multiple telecommunication cables.

16.9 Concurrent deployment or connections by two or more licensees

- 16.9.1 Where two or more licensees concurrently seek to deploy their installation, plant or systems in the relevant space and facilities or concurrently seek to connect their pipes to the lead-in pipes of any development, and such relevant space and facilities are insufficient to accommodate all the installation, or plant or systems sought to be deployed or the lead-in pipes are insufficient to accommodate all the connections sought to be made, the licensees shall first attempt to reach a voluntary sharing arrangement in good faith.
- 16.9.2 In the event that the licensees are unable to reach a sharing arrangement, they may refer the matter to IMDA for a decision which shall be binding on the licensees.
- 16.9.3 In determining the sharing arrangement, IMDA will generally grant priority as follows –
- (a) public telecommunication licensees who require use of the relevant space and facilities to provide services to the development in accordance with their basic service obligations shall have first priority;
 - (b) telecommunication system licensees who require use of the relevant space and facilities to provide services to the development shall have second priority; and
 - (c) telecommunication system licensees who require use of the relevant space and facilities for any other purpose shall have last priority.

16.10 Co-operation to resolve interference

- 16.10.1 Where any installation, plant or system deployed by a licensee in the relevant space and facilities of a development causes interference to the operation of installation, plant or system deployed by any other licensee in the same space and facilities, such licensees shall co-operate in good faith to resolve the interference to ensure minimal disruption to service provisioning.

16.11 Contravention by licensee

- 16.11.1 Where any licensee contravenes any requirement in this chapter, IMDA may require such licensee to rearrange, remove, alter or disconnect any of the installation, plant or system which it has deployed in the relevant space and facilities of any development at its own expense.

16.12 Provision of additional space or facilities

- 16.12.1 Where a licensee requires any additional space or facilities beyond the requirements imposed on developers or owners under this Code, the licensee shall consult with and obtain the approval of the developer or owner for the provision of such additional space and facilities, on such prices, terms and conditions as may be agreed between the parties.

CHAPTER 17 USE OF SPACE AND FACILITIES WITHIN A DEVELOPMENT FOR THE PROVISION OF FIXED TELECOMMUNICATION SERVICES TO PROPERTIES OUTSIDE OF THE DEVELOPMENT

17.1 Application of this chapter

17.1.1 This chapter sets out –

- (a) the obligations and procedures to be observed by a licensee that intends to use the relevant space and facilities set aside for fixed telecommunication services within a development to provide fixed telecommunication services to properties located outside of the development;
- (b) the obligations and procedures to be observed by a developer or owner who is notified by a licensee of such intended use of the space and facilities; and
- (c) the principles that IMDA may adopt in resolving disputes between the parties where IMDA determines that such use of the space and facilities is reasonable.

For the purposes of this chapter, “fixed telecommunication services” refer to telecommunication services that are provided to end users using fixed-line method, and excludes public cellular mobile telecommunication services.

17.2 Overview

17.2.1 The relevant space and facilities provided by a developer or owner of a development which are set aside for fixed telecommunication services are primarily intended for licensees to deploy installation, plant or systems to serve the needs of the development for such services. Accordingly, insofar as the use of the relevant space and facilities is concerned, priority should be accorded to the needs of the development at all times.

17.2.2 Nevertheless, there may be situations where it would be reasonable for a licensee that is using the relevant space and facilities of a development to provide fixed telecommunication services to that development, to also use the relevant space and facilities to provide fixed telecommunication services to properties located outside of the development (hereinafter referred to as “external properties”).

17.2.3 Such situations are specifically contemplated in Section 21(2) of the Telecommunications Act (Cap. 323). In these cases, the licensee is required to notify the developer or owner of its intention to use the relevant space and facilities to serve the external properties. If the developer or owner objects to such intended use, the developer or owner may lodge a written objection with IMDA, and IMDA shall notify the licensee to resolve the dispute. If the dispute cannot be resolved with the developer or owner despite parties taking genuine steps to do so, IMDA shall hold an inquiry into the matter. Where IMDA is satisfied that the licensee’s use of the relevant space and facilities to serve the external properties would be reasonable, IMDA may issue directions to the parties to give effect to the same on such terms and conditions as IMDA may impose.

17.3 Procedures to be observed in relation to the use of relevant space and facilities to serve external properties

- 17.3.1 Where a licensee intends to use the relevant space and facilities set aside for fixed telecommunication services within a development to provide fixed telecommunication services to any external properties, the licensee shall notify the developer or owner of such intention. The notice shall minimally include the following –
- (a) clear indication of the licensee’s intention to use the relevant space and facilities in the development to serve the external properties;
 - (b) description of the installation, plant or system that the licensee will be deploying in the relevant space and facilities to serve the external properties;
 - (c) proposed dates of the deployment of the installation, plant or system and the duration of the deployment period;
 - (d) the nature and extent of the acts intended to be done for the deployment and use of the installation, plant or system to serve the external properties, including the likely frequency of access for the purpose of undertaking any activities in connection with such installation, plant and systems; and
 - (e) a reasonable timeframe (which shall in any case be no less than 14 days) for the developer or owner to raise its objection (if any) to the licensee’s intended use of the relevant space and facilities to serve the external properties.
- 17.3.2 Where the developer or owner objects to the licensee’s intended use of the relevant space and facilities to serve the external properties, the developer or owner shall lodge a written objection to IMDA within the stipulated timeframe in the notification and state the reasons for its objection.
- 17.3.3 Upon receipt of the developer’s or owner’s written objection, IMDA will notify the licensee to resolve the dispute with the developer or owner.
- 17.3.4 The licensee and the developer or owner shall take genuine steps to resolve the dispute and seek to arrive at a mutually acceptable agreement on the use of the relevant space and facilities to serve the external properties.
- 17.3.5 Where the dispute cannot be resolved despite the genuine efforts of the parties, the licensee shall inform IMDA of the same and furnish all relevant information relating to the steps taken to resolve the dispute.
- 17.3.6 After receipt of the information above, IMDA will notify parties as to whether IMDA is satisfied that genuine steps were taken to resolve the dispute and if so satisfied, IMDA will hold an inquiry giving each party the reasonable opportunity to make representations to IMDA in accordance with such process as IMDA may specify.
- 17.3.7 Upon the conclusion of the inquiry, where IMDA determines that the licensee’s intended use of the relevant space and facilities to serve the external properties is reasonable, IMDA may issue directions to –
- (a) require the developer or owner to allow the licensee to use the relevant space and facilities to provide fixed telecommunication services to the external properties; and

- (b) require the licensee to install and operate any installation, plant or systems within the relevant space and facilities to provide fixed telecommunication services to the external properties,

in such manner and on such terms and conditions as IMDA may specify in the directions.

17.3.8 IMDA's determination of –

- (a) whether it would be reasonable for a licensee to use the relevant space and facilities to serve the external properties; and/or
- (b) the terms and conditions to be imposed on the parties where IMDA assesses that such use should be allowed,

will be undertaken by IMDA on a case-by-case basis having regard to all relevant facts, including factors such as the availability of the relevant space and facilities for such intended use, as well as any safety and security considerations which IMDA considers to be relevant.

- 17.3.9 Without prejudice to paragraphs 17.3.7 and 17.3.8 above, where IMDA considers that it would be reasonable to allow a licensee to use the relevant space and facilities to serve any external properties, IMDA may (but is not bound to) adopt the principles set out in paragraph 17.4 below when specifying the terms and conditions to be complied with by the licensee and the developer or owner in relation to such use of the relevant space and facilities. Parties are therefore encouraged to refer to the said principles with a view to arriving at a mutually acceptable agreement without the need for IMDA's intervention.

17.4 Guiding principles on the use of the relevant space and facilities to serve external properties

- 17.4.1 In all instances, priority in the use of the relevant space and facilities set aside for fixed telecommunication services within a development must be accorded to the immediate and foreseeable needs of the development for such services before such space and facilities may be used to serve external properties.
- 17.4.2 In the event that the installation, plant or system deployed by a licensee to serve the external properties impedes or causes obstruction to any future deployment of installation, plant or system by other licensees to serve the needs of the development for fixed telecommunication services, the licensee shall –
- (a) remove its installation, plant or system at its own costs and reinstate as far as reasonably practicable to their original condition the relevant space and facilities which were used; or
 - (b) pay for the costs of any additional space and facilities required to accommodate such future deployment needs where it is feasible for such additional space and facilities to be provided.
- 17.4.3 The licensee shall comply with any reasonable measures that the developer or owner may impose to safeguard the safety and security of the development, in connection with the licensee's activities relating to the installation, plant or system that are deployed to serve the external properties.

- 17.4.4 The licensee shall bear all risks in relation to the installation, plant or system that are deployed to serve the external properties. In this regard, the licensee (and all persons claiming under it) shall waive the right to make any claims against the developer or owner and any occupants of the development for any loss or damage caused to such installation, plant or system howsoever arising save where such loss or damage is wilfully caused by such persons.
- 17.4.5 The licensee shall –
- (a) fully compensate the developer or owner and the occupants of the development for any loss or damage caused to the development or its occupants; and
 - (b) fully indemnify the developer or owner and the occupants of the development against any claims whatsoever made against them by any person,
- arising out of or in connection with the licensee’s activities relating to the installation, plant or system that are deployed to serve the external properties.
- 17.4.6 The licensee shall comply with the rules of usage set out in Chapter 16, which shall equally apply to the licensee’s use of the relevant space and facilities to serve external properties.
- 17.4.7 Where it is reasonably necessary for the installation, plant or system that are deployed by the licensee to serve the external properties to be altered, removed, relocated or diverted (for example, where the development is being redeveloped or due to be demolished), the licensee shall bear the costs of all such alteration, removal, relocation or diversion works.
- 17.4.8 Save where otherwise provided in this Code, the developer or owner shall not impose any charges, fees or rent for the licensee’s use of the relevant space and facilities to serve any external properties.
- 17.4.9 Where the developer or owner is required to incur any additional costs in granting access to the licensee to carry out any activities relating to the installation, plant or system that are deployed to serve the external properties, the developer or owner may recover these costs from the licensee subject to the developer or owner demonstrating that it is reasonable for such costs to be incurred.
- 17.4.10 In addition to allowing the licensee to deploy its installation, plant or system to serve the external properties, the developer or owner shall co-operate in good faith with the licensee to grant the licensee such continuing access to the development as the licensee may from time to time require to carry out any activities relating to such installation, plant or system, including the activation and deactivation of services, inspection, maintenance and repair.
- 17.4.11 Where a licensee requires Emergency Access to the relevant space and facilities, the developer or owner shall, upon receipt of such notice by the licensee, grant the licensee access in accordance with the timeframes specified in paragraph 2.5.4. “Emergency Access” refers to the access required by a licensee for any of the following purposes –
- (a) to carry out urgent works to restore its services due to unforeseen and unscheduled outages, disruptions or downtime, which cannot be resolved by the licensee remotely; or

- (b) to take any action in relation to its installation, plant or systems deployed within the relevant space and facilities in order to comply with any applicable laws, regulatory requirements or lawful orders issued by any competent authority to the licensee.

For the avoidance of doubt, the foregoing shall not in any way limit or affect the developer's or owner's obligation to comply with any applicable laws, regulatory requirements or lawful orders issued by any competent authority to the developer or owner in connection with the relevant space and facilities, and access thereto.

- 17.4.12 Where the developer or owner incurs any reasonable cost and expense in providing Emergency Access to the licensee (e.g. engagement of security escort for unmanned buildings), the licensee shall bear such cost and expense.